



Post for freestanding installation

IHP

16970

SEG 85 701 39

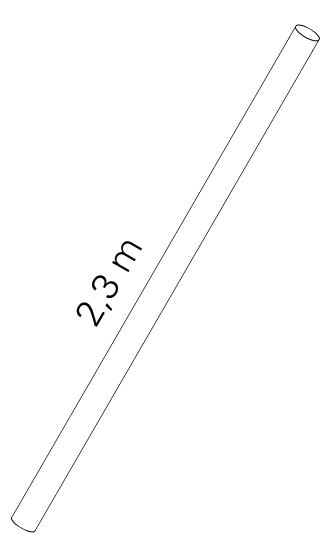
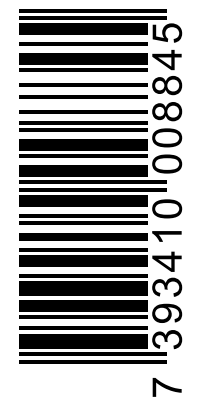

x1



x1



x1



x1

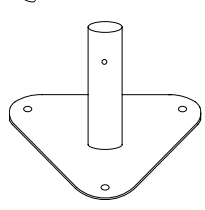

x1

Get In Touch

Call: [0845 6880112](tel:08456880112)
 Email: info@adremit.co.uk

Our Address

Puravent, Adremit Limited, Unit 5a, Commercial Yard,
 Settle, North Yorkshire, BD24 9RH



IHP

A

NOT INCLUDED

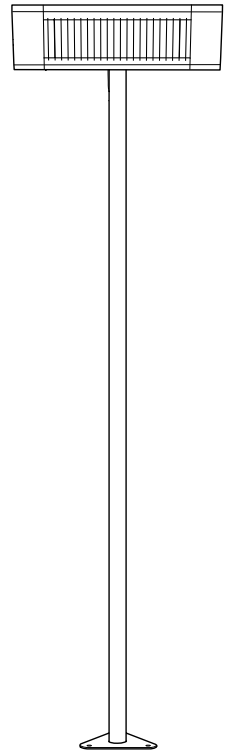
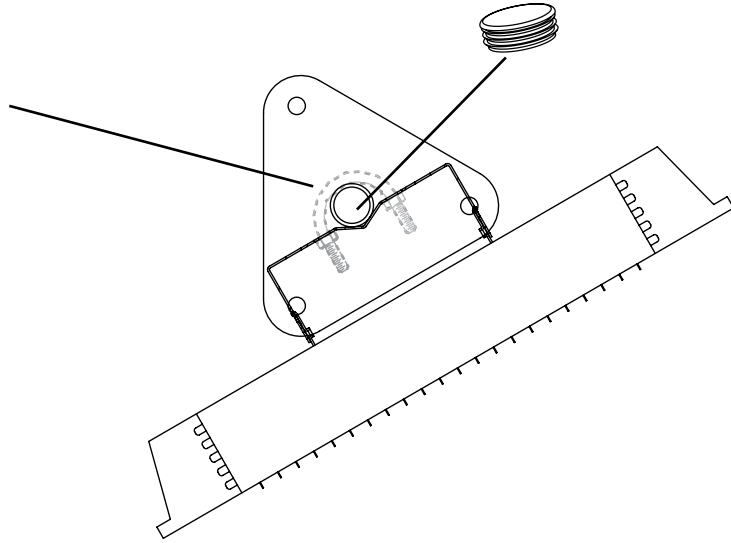
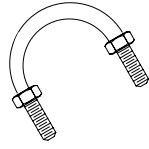

B

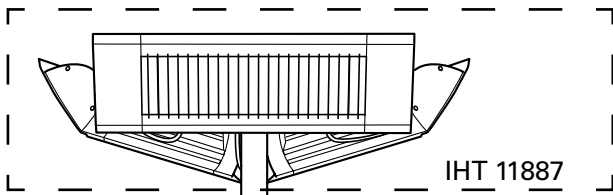

IHT 11887

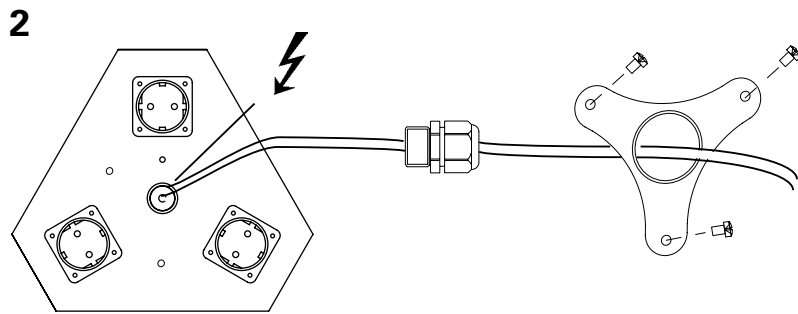
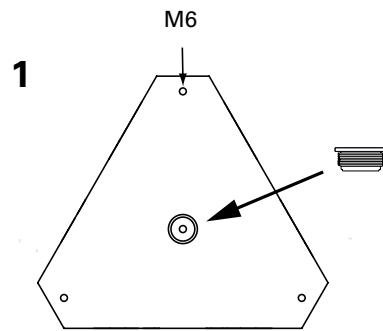

2

Get In Touch

Call: [0845 6880112](tel:08456880112)
Email: info@adremit.co.uk

Our Address

Puravent, Adremit Limited, Unit 5a, Commercial Yard,
Settle, North Yorkshire, BD24 9RH





IHP

3

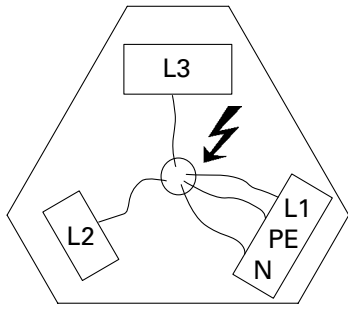

4

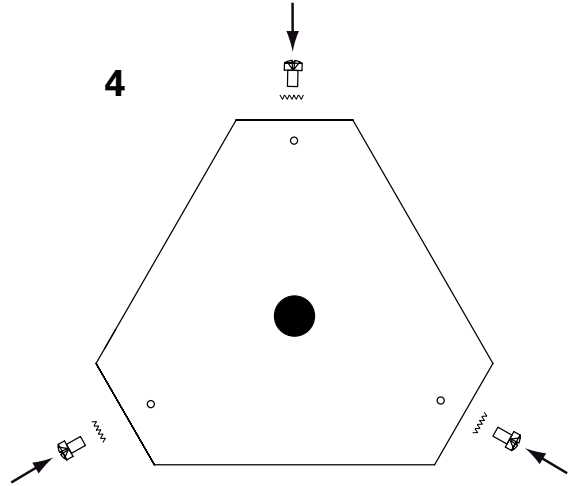

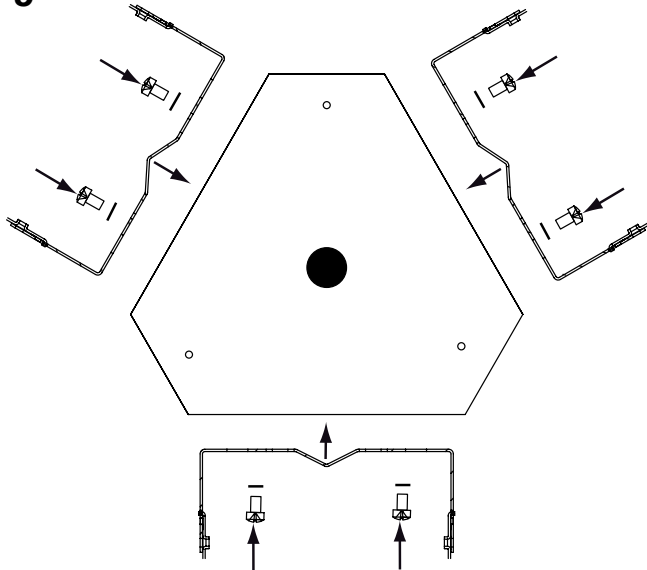

5

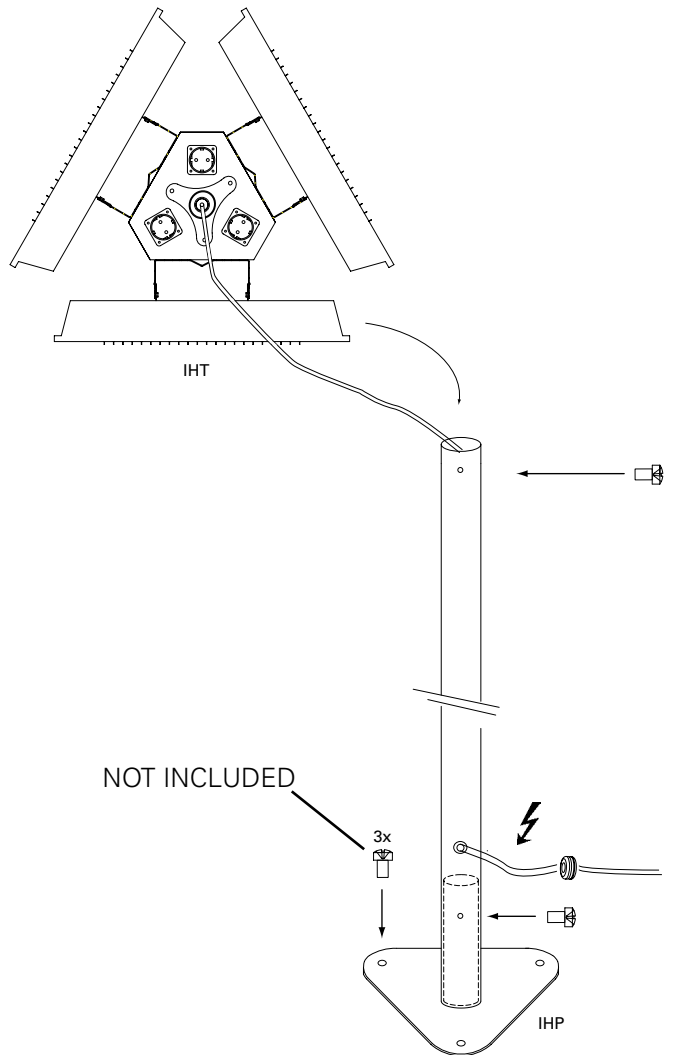

6



Get In Touch

 Call: [0845 6880112](tel:08456880112)
 Email: info@adremit.co.uk

Our Address

Puravent, Adremit Limited, Unit 5a, Commercial Yard,
 Settle, North Yorkshire, BD24 9RH





Main office



Frico AB
Box 102
SE-433 22 Partille
Sweden

Tel: +46 31 336 86 00
Fax: +46 31 26 28 25
mailbox@frico.se
www.frico.se

**For latest updated information and information
about your local contact: www.frico.se**

E4487, 120110 HH

Get In Touch

 **Call:** [0845 6880112](tel:08456880112)
 **Email:** info@adremit.co.uk

Our Address

Puravent, Adremit Limited, Unit 5a, Commercial Yard,
Settle, North Yorkshire, BD24 9RH

