

BOR-R

Residential Supply Diffuser

Data Sheet



Get In Touch



Call: [0845 6880112](tel:08456880112)



Email: info@adremit.co.uk

Our Address

Puravent, Adremit Limited, Unit 5a, Commercial Yard,
Settle, North Yorkshire, BD24 9RH



Table of Contents

Description	3
Design	4
Dimensions	4
Ordering Code	5
Quick Selection	5
Technical Parameters	6
Installation, Maintenance & Operation	7
Transport & Storage	7
Supplement	7
Related Product	7

Get In Touch

 **Call:** [0845 6880112](tel:08456880112)
 **Email:** info@adremit.co.uk

Our Address

Puravent, Adremit Limited, Unit 5a, Commercial Yard,
Settle, North Yorkshire, BD24 9RH



Description

BOR-R is a residential diffuser, developed to provide a draught-free and low acoustic noise air supply. The product is equipped for air flow adjustment and commissioning measurement. It can be installed on rear walls of offices, hotels, residential rooms etc. or as a part of VAV system.

Highlights

- Very low acoustic noise
- Easy and precise supply air flow measurement and adjustment, no dismantling required
- Front plate detachable without tools for cleaning
- Short duct connection for installation in thin walls

Get In Touch



Call: [0845 6880112](tel:08456880112)



Email: info@adremit.co.uk

Our Address

Puravent, Adremit Limited, Unit 5a, Commercial Yard,
Settle, North Yorkshire, BD24 9RH

Design

The body of BOR-R is manufactured from galvanized steel with a convex, circular shaped front plate with perforation. The front plate is finished in the signal white RAL9003 or white RAL 9010, gloss 30 powder coating as standard. Other RAL colours are possible upon request. Inside the body a flat adjustable blind is attached.

Product Parts & Setup Possibilities

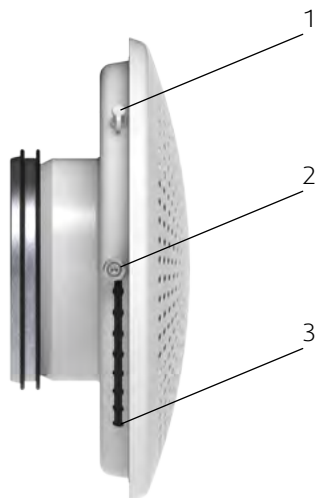

Fig. 1: Components of the BOR-R

The diffuser is equipped by an adjustable blind that changes the effective air flow aperture and so tunes the air flow volume. The mechanism is movable from outside by a miniature knob. The movement has 9 fixed positions. For adjustment only these positions provide desired noise parameters. The intermediate positions shall be avoided.

Legend

1	ΔP measurement pin
2	Adjustment knob parked in position 1. To move the knob pull it radially out of the body and slide pulled into other position, then release to park it.
3	Adjustment position 9

Dimensions

BOR-R is available in connection sizes $\varnothing DN$ 100 mm and $\varnothing DN$ 125 mm.

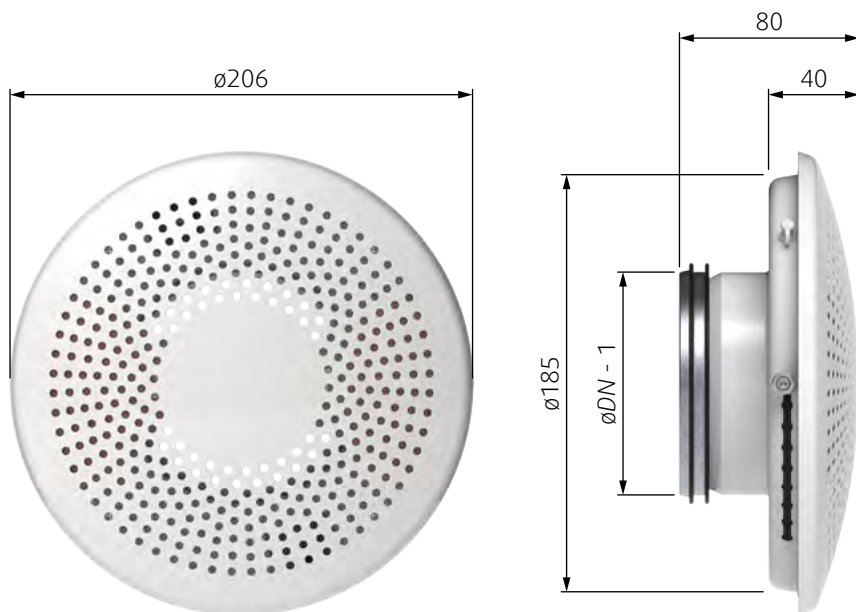

Fig. 2: Dimensions of the BOR-R

NOTE: BOR-R-100: $\varnothing = 99$ mm; BOR-R-125: $\varnothing = 124$ mm



Get In Touch

Call: 0845 6880112
 Email: info@adremit.co.uk

Our Address

Puravent, Adremit Limited, Unit 5a, Commercial Yard, Settle, North Yorkshire, BD24 9RH

Ordering Code

Connection size (mm)		BOR-R-	<input type="checkbox"/>	<input type="checkbox"/>
		100		
Surface finish *	RAL9010 white		W	
	RAL9003 signal white		SW	
	Other colour	RALXXXX		

* NOTE: If no Surface finish is defined, signal white powder coating (RAL9003) will be delivered.

Example of the Ordering Code

BOR-R-100-SW

Diffuser with connection size 100 mm, signal white powder coating.

Quick Selection

Tab. 1: Quick selection with air flow position 1 adjusted

Type	Air flow volume q and pressure drop ΔP at different sound power levels L_{WA}								
	$L_{WA} = 25$ dB			$L_{WA} = 30$ dB			$L_{WA} = 35$ dB		
	q (m ³ /h)	q (l/s)	ΔP (Pa)	q (m ³ /h)	q (l/s)	ΔP (Pa)	q (m ³ /h)	q (l/s)	ΔP (Pa)
BOR-R-100	54	15	35	64	18	50	75	21	69
BOR-R-125	67	19	32	87	24	54	111	31	89

Get In Touch

 Call: [0845 6880112](tel:08456880112)
 Email: info@adremit.co.uk

Our Address

Puravent, Adremit Limited, Unit 5a, Commercial Yard,
Settle, North Yorkshire, BD24 9RH

Technical Parameters

Legend

p_s	Pa	Pressure drop
q_v	m ³ /h l/s	Air flow volume
L_{WA}	dB(A)	Total A-weighted sound power level
$L_{0,2}$	m	Air throw length with terminal velocity 0,2 m/s
L_x	m	Air throw length calculated for specific terminal velocity
x	m/s	Terminal velocity in range of 0,1 m/s ... 1 m/s
1, 2, ... 9		Air flow adjustment positions

Calculation of Air Throw for Different Terminal Velocities

$$L_x = L_{0,2} \cdot 0,2/x$$

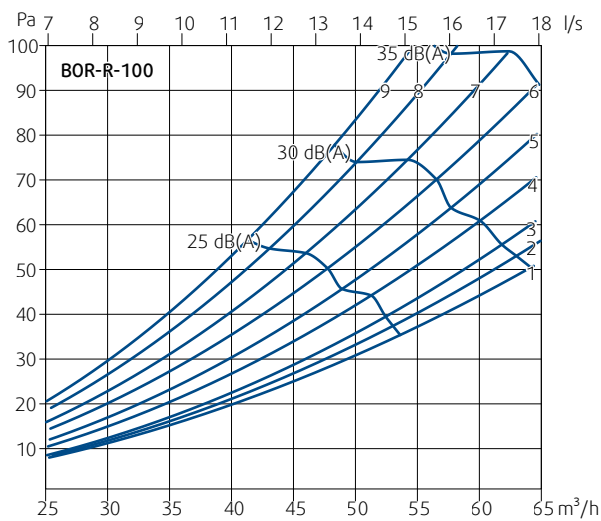

Diagram 1: Pressure drop & A-weighted total sound power level, depending on supply air flow volume

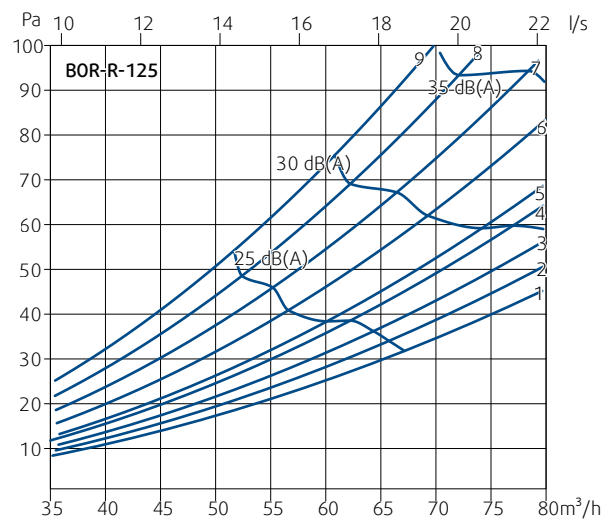

Diagram 3: Pressure drop & A-weighted total sound power level, depending on supply air flow volume

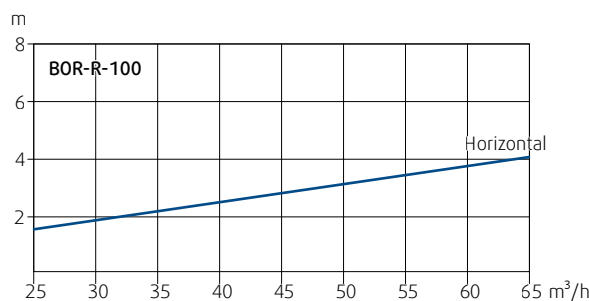

Diagram 2: Isothermal air throw lengths for horizontal radial discharge with terminal velocity 0,2 m/s, depending on air flow volume

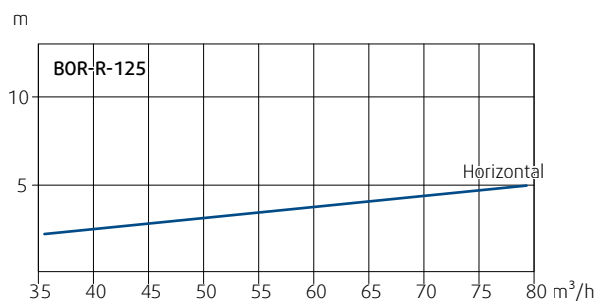

Diagram 4: Isothermal air throw lengths for horizontal radial discharge with terminal velocity 0,2 m/s, depending on air flow volume



Get In Touch

Call: 0845 6880112
Email: info@adremit.co.uk

Our Address

Puravent, Adremit Limited, Unit 5a, Commercial Yard, Settle, North Yorkshire, BD24 9RH



Installation, Maintenance & Operation

Information about installation, maintenance and operation is available in the document ["UserManual_BOR-R"](#) or follow the instruction for residential diffusers on [Systemair DESIGN](#).

Transport & Storage

Dry indoor conditions with a temperature range of -40°C to +50°C.

Supplement

Any deviations from the technical specifications contained herein and the terms should be discussed with the manufacturer. We reserve the right to make any changes to the product without prior notice, provided that these changes do not affect the quality of the product and the required parameters.

Current information on all products is available at www.systemair.com

Related Product

BOR-S

Residential Supply Diffusers

Product information is available within the technical documentation ["DataSheet_BOR-S"](#) and at [Systemair DESIGN](#).



Get In Touch



Call: [0845 6880112](tel:08456880112)



Email: info@adremit.co.uk

Our Address



Puravent, Adremit Limited, Unit 5a, Commercial Yard,
Settle, North Yorkshire, BD24 9RH



www.systemair.com

Systemair Production a.s. - February 2019 - DataSheet_B0R-R

Get In Touch

 **Call:** [0845 6880112](tel:08456880112)
 **Email:** info@adremit.co.uk

Our Address

Puravent, Adremit Limited, Unit 5a, Commercial Yard,
Settle, North Yorkshire, BD24 9RH

