



# VKS 560/630 BACK DRAFT DAMPER

Item no. 9545

Document type: **Product card**  
Document date: **2019-05-15**  
Generated by: **Systemair Online Catalogue**

## Description

VKS automatic shutter

Consists of flanges manufactured from galvanized steel, and of shutter blades manufactured from seawater resistant aluminium.

Suitable for DVS/DHS, DVSI, DVN.

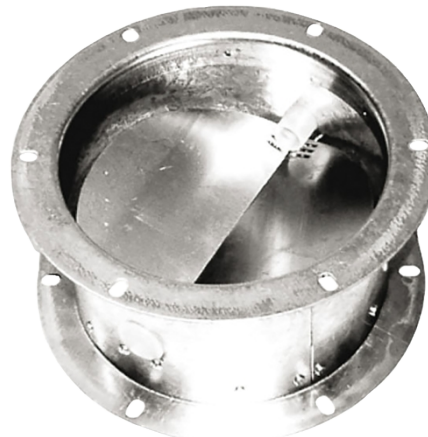

## Technical parameters

Other	
Weight	7,6 kg

### Get In Touch

Call: [0845 6880112](tel:08456880112)  
 Email: [info@adremit.co.uk](mailto:info@adremit.co.uk)

### Our Address

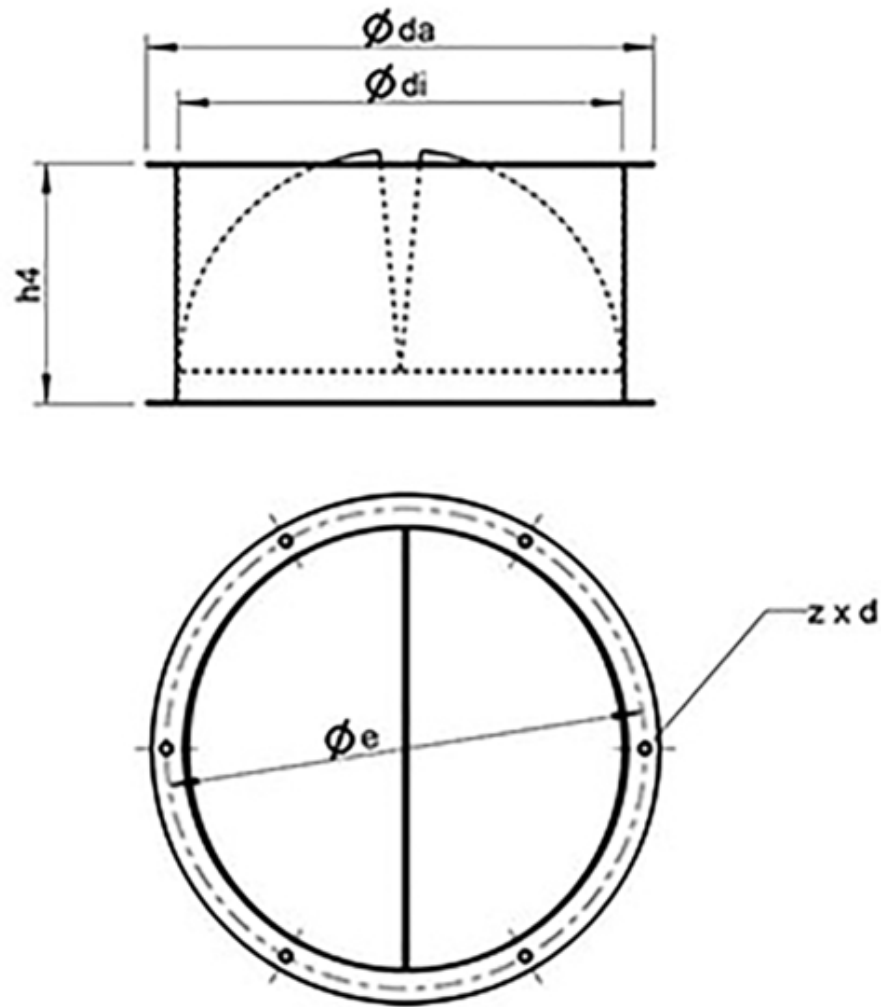

Puravent, Adremit Limited, Unit 5a, Commercial Yard,  
Settle, North Yorkshire, BD24 9RH

## Dimensions



	$\varnothing da$	$\varnothing e$	$\varnothing di$	$h4$	$z \times d$
VKS 560/630	639	605	573	255	8 x $\varnothing 10$

### Get In Touch

 Call: [0845 6880112](tel:08456880112)  
 Email: [info@adremit.co.uk](mailto:info@adremit.co.uk)

### Our Address

Puravent, Adremit Limited, Unit 5a, Commercial Yard,  
Settle, North Yorkshire, BD24 9RH

## Diagram

Pressure drop diagram

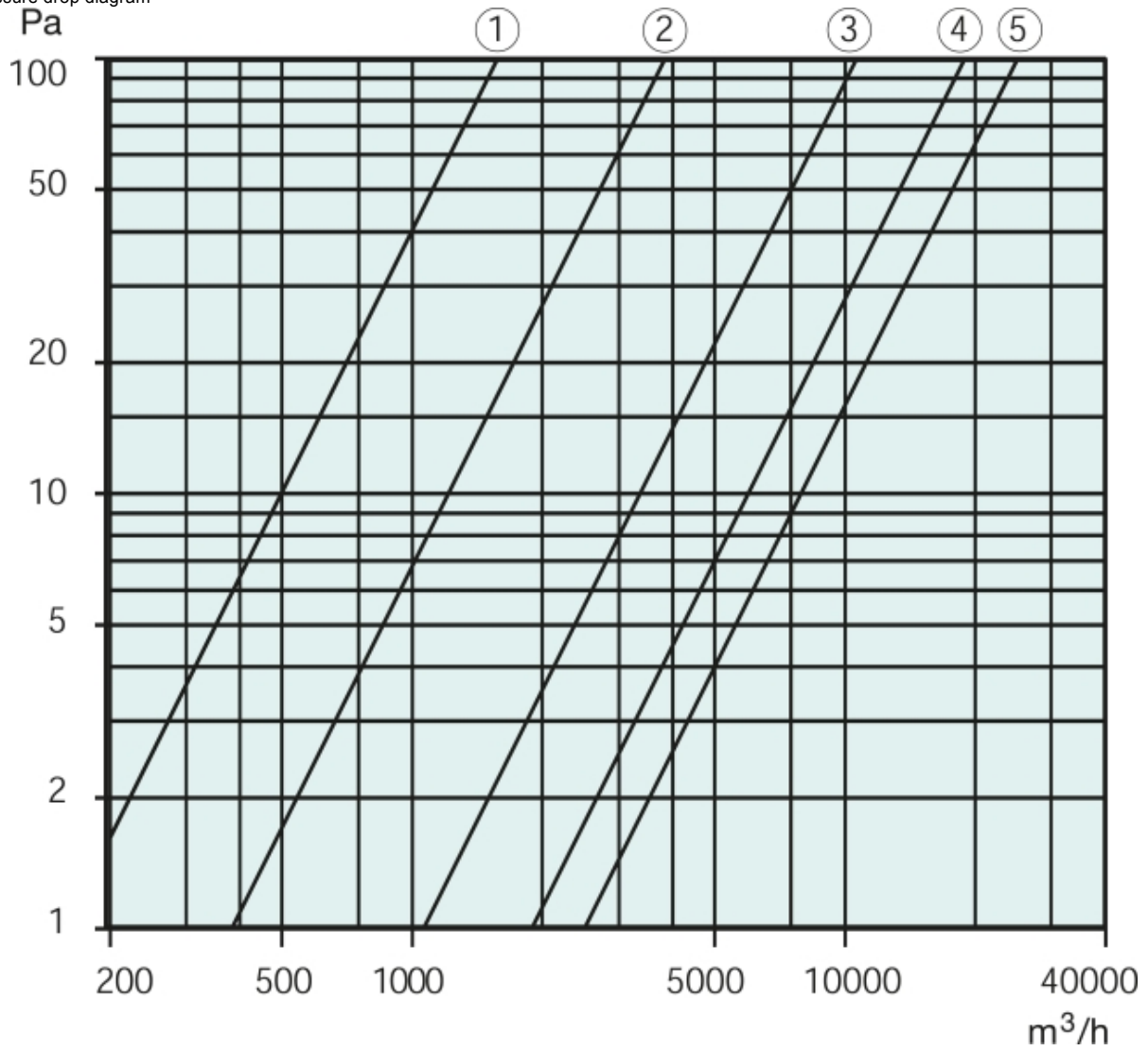



- 1 VKS 190/225
- 2 VKS/VKM 310/311
- 3 VKS/VKM 355-500
- 4 VKS/VKM 560/630
- 5 VKS/VKM 710
- 6 VKS/VKM 800/900

Name: **VKS 560/630 BACK DRAFT DAMPER** | Item no.: **9545**

Document type: **Product card** | Document date: **2019-05-15** | Generated by: **Online catalogue**

3 / 3

### Get In Touch

 Call: [0845 6880112](tel:08456880112)  
 Email: [info@adremit.co.uk](mailto:info@adremit.co.uk)

### Our Address

Puravent, Adremit Limited, Unit 5a, Commercial Yard,  
Settle, North Yorkshire, BD24 9RH