



VKS-EX 560/630 BACK DRAFT DA.

Item no. 4813

Document type: **Product card**

Document date: **2019-05-14**

Generated by: **Systemair Online Catalogue**

Description

Automatic shutter

The automatic shutter VKS-EX consists of flanges manufactured from galvanized steel epoxy painted RAL 9005, and of shutter blades manufactured from painted galvanized steel RAL 9005.

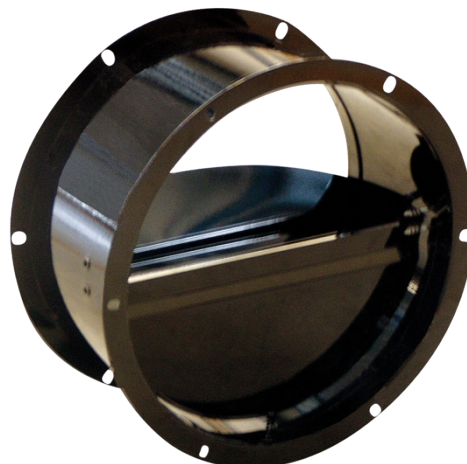

Technical parameters

Other	
Weight	9,3 kg

Get In Touch

 Call: [0845 6880112](tel:08456880112)
 Email: info@adremit.co.uk

Our Address

Puravent, Adremit Limited, Unit 5a, Commercial Yard,
Settle, North Yorkshire, BD24 9RH

Dimensions

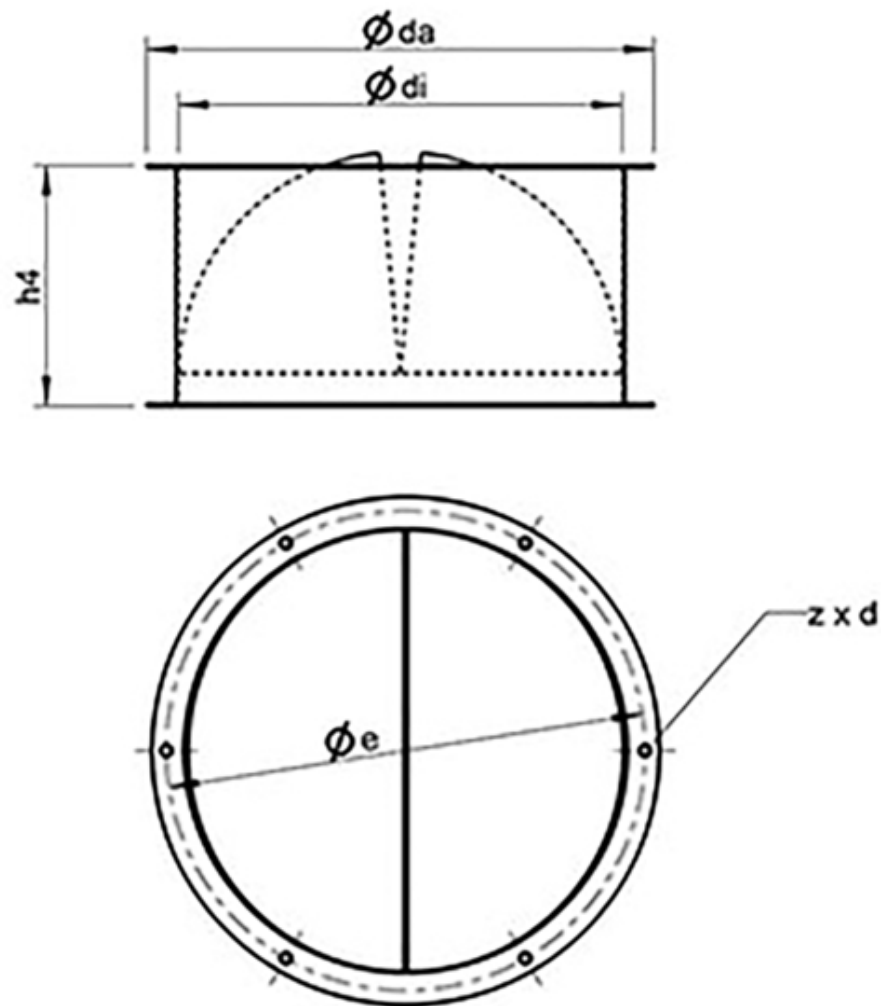

	$\varnothing da$	$\varnothing e$	$\varnothing di$	$h4$	$z \times d$
VKS-EX 560/630	639	605	569	255	8 x $\varnothing 9$

Documentation

 [VKS-EX-EC-Declaraton of conformity.pdf](#) (84,22kB)

 [Company statement_ATEX_Acce._eng.pdf](#) (90,44kB)

Get In Touch



Call: [0845 6880112](tel:08456880112)



Email: info@adremit.co.uk

Our Address

Puravent, Adremit Limited, Unit 5a, Commercial Yard,
Settle, North Yorkshire, BD24 9RH

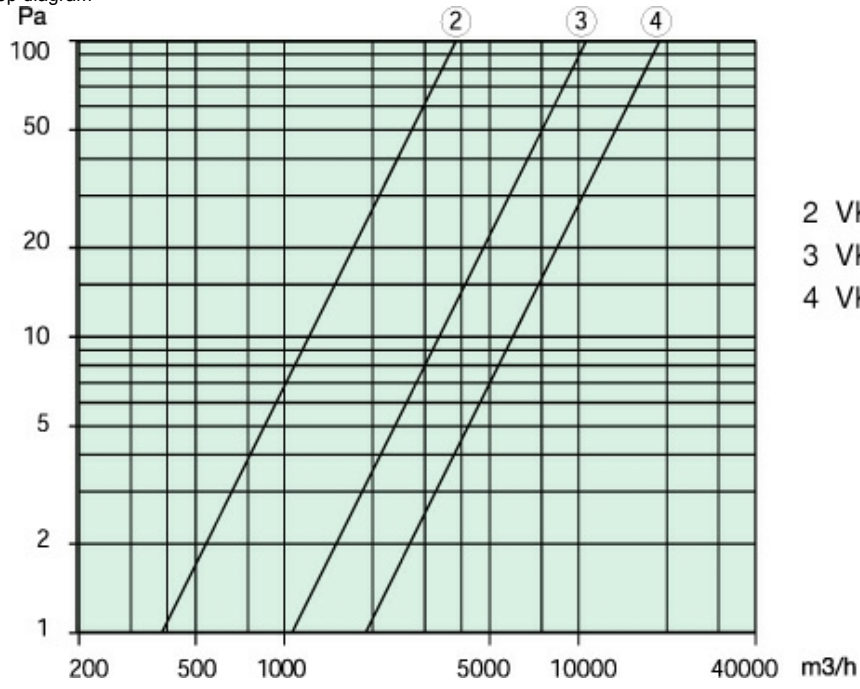

Diagram

Pressure drop diagram



- 2 VKS-EX 310/311
- 3 VKS-EX 355-500
- 4 VKS-EX 560/630

Get In Touch

 Call: [0845 6880112](tel:08456880112)
 Email: info@adremit.co.uk

Our Address

Puravent, Adremit Limited, Unit 5a, Commercial Yard,
Settle, North Yorkshire, BD24 9RH