



VKM 560/630 BACK DRAFT DAMPER

Item no. 9557

Document type: **Product card**
 Document date: **2019-05-15**
 Generated by: **Systemair Online Catalogue**

Description

VKM motor driven shutter

Consists of flanges manufactured from galvanized steel, and of shutter blades manufactured from seawater resistant aluminium.
 Is equipped with a servo motor (230V/50Hz/25W), which can be operated manually as well as through the automatic controllers of the air conditioning unit. While the motor is energized the shutter stays open. When separated from the supply the shutter will close automatically.
 Temperature approx 70°C.

Suitable for DVS/DHS, DVSI, DVN.



Technical parameters

Other	
Weight	8,9 kg
Default group	
Voltage	230 V
Phase	1 ~
Frequency	50 Hz
Enclosure class, motor	IP43

Get In Touch

Call: [0845 6880112](tel:08456880112)
 Email: info@adremit.co.uk

Our Address

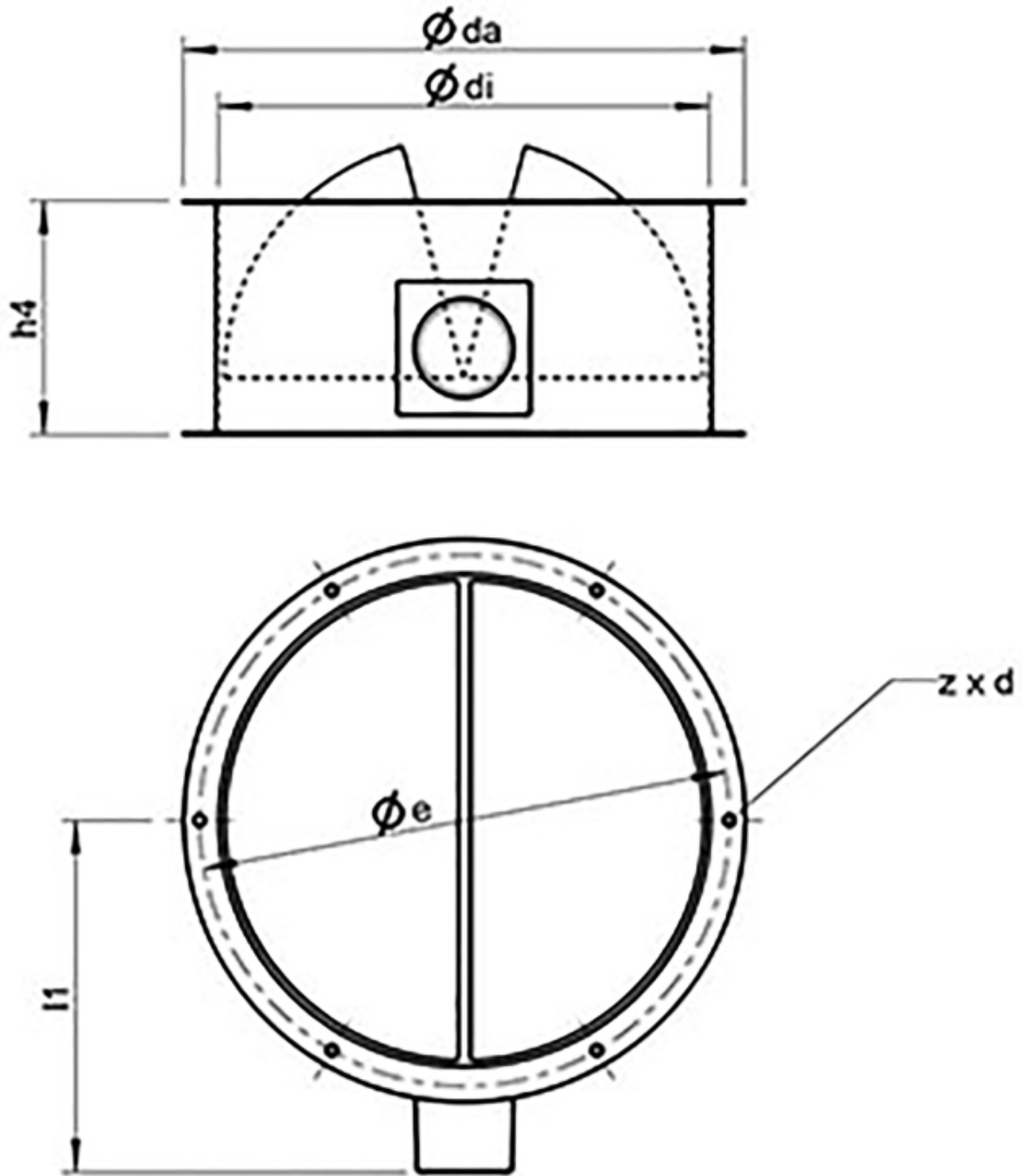

Puravent, Adremit Limited, Unit 5a, Commercial Yard,
 Settle, North Yorkshire, BD24 9RH

Dimensions



	$\varnothing da$	$\varnothing e$	$\varnothing di$	$h4$	$l1$	$z \times d$
VKM 560/630	639	605	573	255	375	8 x $\varnothing 10$

Get In Touch

 Call: [0845 6880112](tel:08456880112)
 Email: info@adremit.co.uk

Our Address

Puravent, Adremit Limited, Unit 5a, Commercial Yard,
Settle, North Yorkshire, BD24 9RH



Diagram

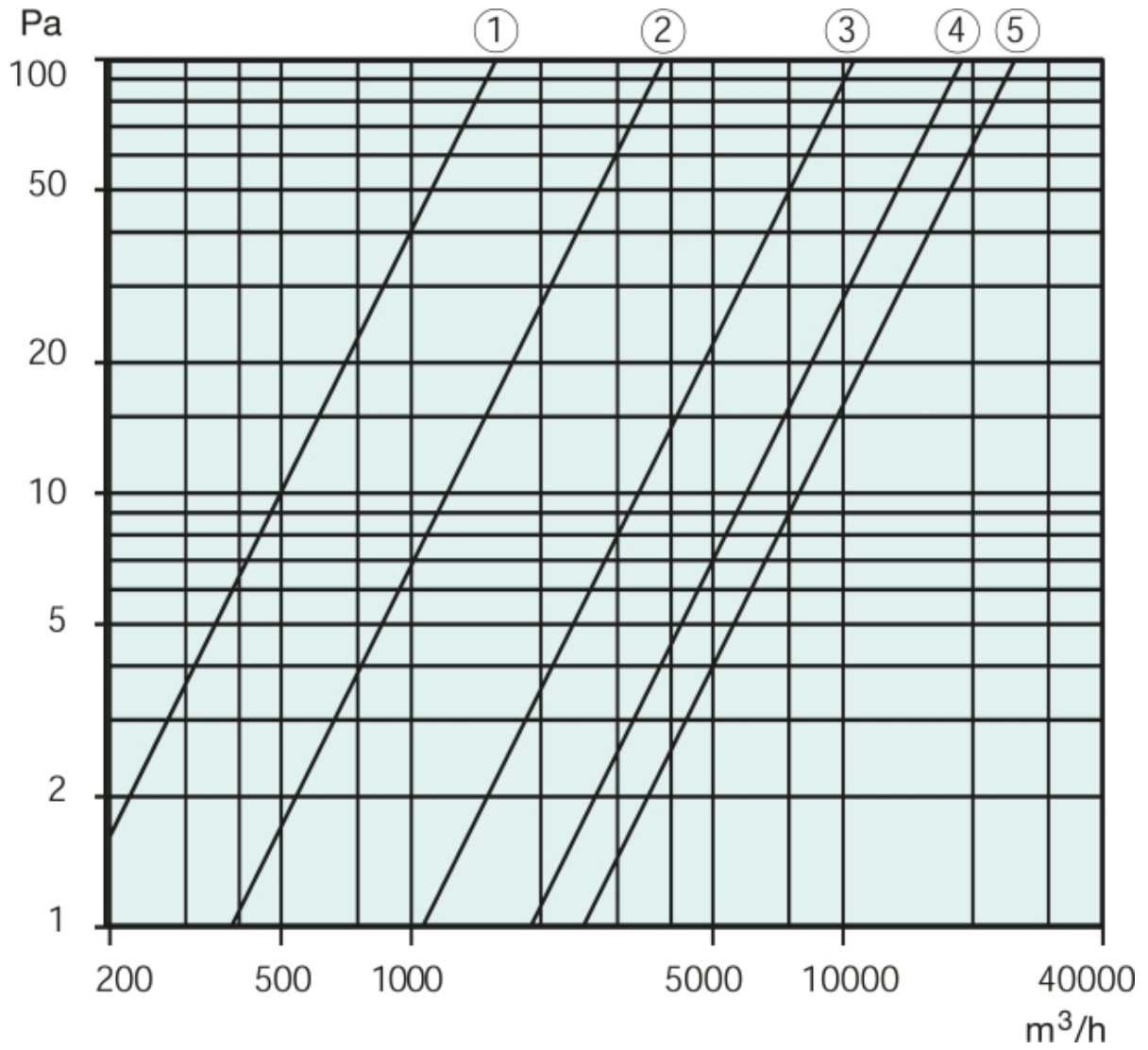

Pressure drop diagram

Get In Touch

Call: [0845 6880112](tel:08456880112)
Email: info@adremit.co.uk

Our Address

Puravent, Adremit Limited, Unit 5a, Commercial Yard,
Settle, North Yorkshire, BD24 9RH





Wiring

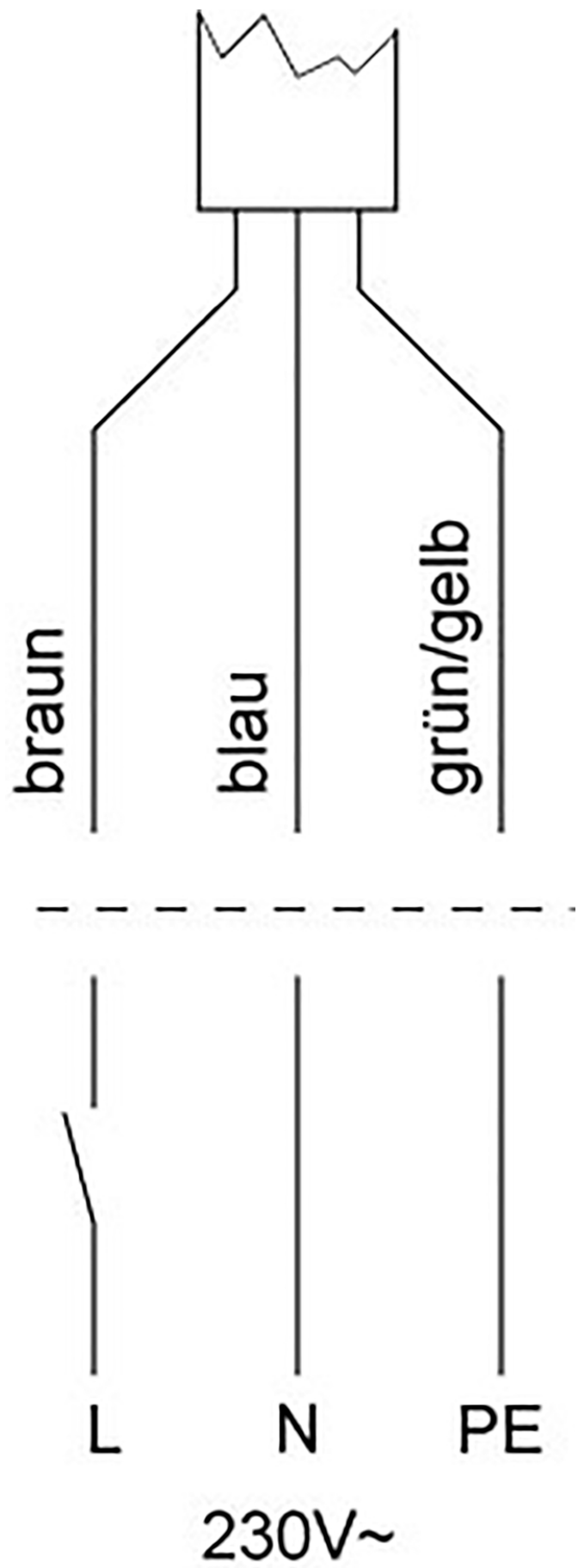



Name: **VKM 560/630 BACK DRAFT DAMPER** | Item no.: **9557**

4 / 5

Document type: **Product card** | Document date: **2019-05-15** | Generated by: **Online catalogue**

Get In Touch

 Call: [0845 6880112](tel:08456880112)
 Email: info@adremit.co.uk

Our Address

Puravent, Adremit Limited, Unit 5a, Commercial Yard,
Settle, North Yorkshire, BD24 9RH





Colours

braun = brown
blau = blue
grün/gelb = green/yellow

Get In Touch



Call: [0845 6880112](tel:08456880112)



Email: info@adremit.co.uk

Our Address

Puravent, Adremit Limited, Unit 5a, Commercial Yard,
Settle, North Yorkshire, BD24 9RH