



VKK-400 BACK DRAFT DAMPER

Item no. 1629

Document type: **Product card**
 Document date: **2019-05-15**
 Generated by: **Systemair Online Catalogue**

Description

Back draft damper for installation in horizontal ducts. The profiled vanes produce a strong upward force which reduces the air resistance. This means that the vanes opens fully at low air velocities as well. The box is manufactured from galvanised sheet steel. The damper inside the box is manufactured in weather-resistant and shock-proof nylon material. The robust construction ensures that the vanes will not become deformed or loose. Air velocity should not exceed 12 m/s.



Dimensions

	∅	A	B	C	D	E
VKK 100	100	123	199	205	200	201
VKK 125	125	123	199	205	200	201
VKK 160	160	123	199	205	200	201
VKK 200	200	123	199	302	300	297
VKK 250	250	123	239	302	300	297
VKK 315	315	123	239	350	345	345
VKK 400	400	123	259	454	450	450

* Airflow

** Free area

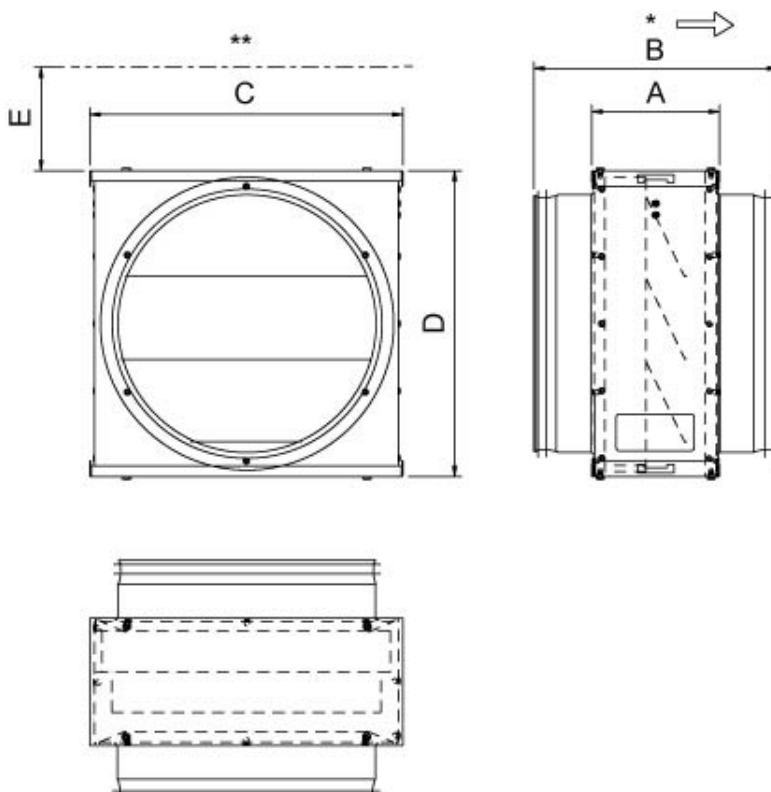

Get In Touch

Call: [0845 6880112](tel:08456880112)
 Email: info@adremit.co.uk

Our Address

Puravent, Adremit Limited, Unit 5a, Commercial Yard,
 Settle, North Yorkshire, BD24 9RH

Diagram

...

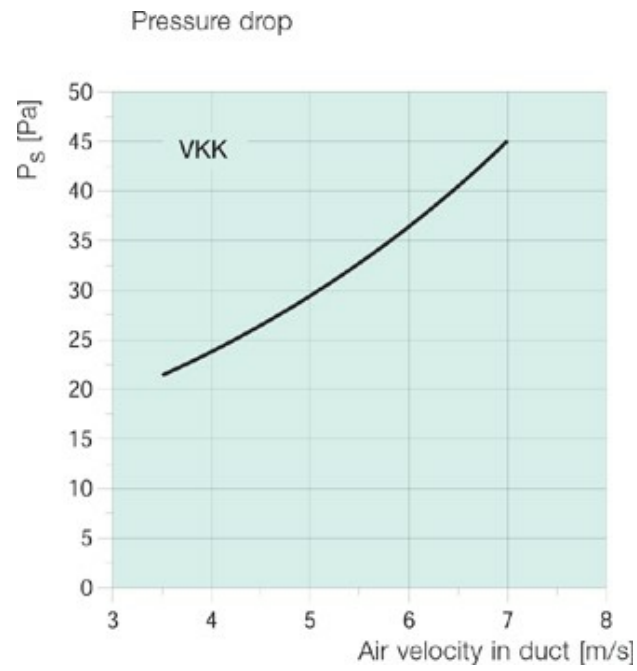

Get In Touch



Call: [0845 6880112](tel:08456880112)



Email: info@adremit.co.uk

Our Address

Puravent, Adremit Limited, Unit 5a, Commercial Yard,
Settle, North Yorkshire, BD24 9RH