



# UGS 062/630 ADAPTER FLEX.

Item no. 4358

Document type: **Product card**  
Document date: **2019-05-21**  
Generated by: **Systemair Online Catalogue**

## Description

Adaptor flexible square to circular

Reduction from square to round. The frame is manufactured from aluminium and neoprene coated fabric. For temperature up to 60°C. The circular side has a locking ring for easy installation to the duct system.

Suitable for MUB and K.. airhandling units.

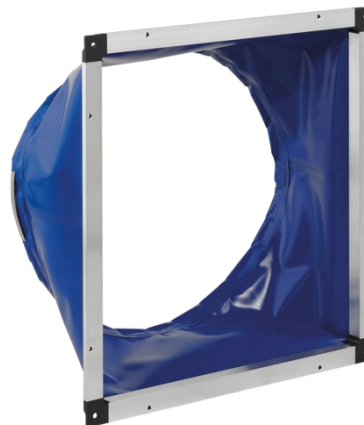

## Technical parameters

Other	
Weight	1,8 kg

### Get In Touch

Call: [0845 6880112](tel:08456880112)  
 Email: [info@adremit.co.uk](mailto:info@adremit.co.uk)

### Our Address

Puravent, Adremit Limited, Unit 5a, Commercial Yard,  
Settle, North Yorkshire, BD24 9RH



## Dimensions

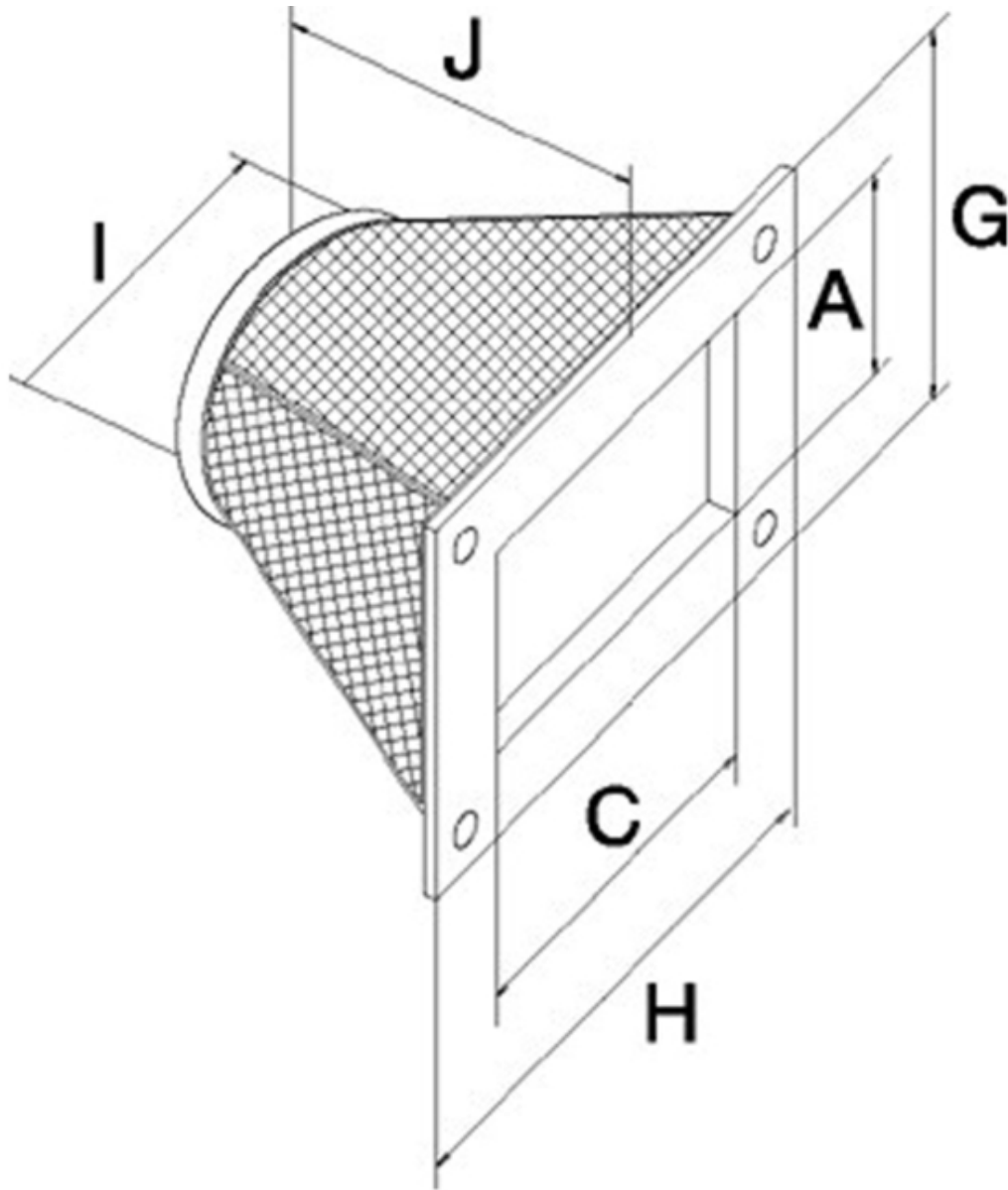

A/C	G/H	I	J
UGS 062/630	658	718	630 210

## Accessories



## Documentation

Name: **UGS 062/630 ADAPTER FLEX.** | Item no.: **4358**

Document type: **Product card** | Document date: **2019-05-21** | Generated by: **Online catalogue**

2 / 2

## Get In Touch

 Call: [0845 6880112](tel:08456880112)  
 Email: [info@adremit.co.uk](mailto:info@adremit.co.uk)

## Our Address

Puravent, Adremit Limited, Unit 5a, Commercial Yard,  
Settle, North Yorkshire, BD24 9RH