



# THB 200 HOOD W.COVER PL. BLACK

Item no. 134465

Document type: **Product card**  
Document date: **2019-06-05**  
Generated by: **Systemair Online Catalogue**

## Description

Profiled cowl

This cowl is shaped so as to fit over a standard double-lap concrete roof tile (THB 160), or over two tiles (THB 200). The cowl is fitted at right angles to the roof cladding and can therefore be used on different roof pitches.

Manufactured from powder-coated, galvanised sheet steel, in the standard colours of black and brick red. The spiral pipe connected to the cover is insulated with 30 mm rockwool matting. The TUB under-plate, for fitting inside the roof, is included. This under-plate prevents water-damage via the roof aperture if there is leakage on the outside of the roof. The under-plate should not be used if the roof is only covered with roofing felt.



## Technical parameters

Other	
Weight	10,2 kg

### Get In Touch

 Call: [0845 6880112](tel:08456880112)  
 Email: [info@adremit.co.uk](mailto:info@adremit.co.uk)

### Our Address

Puravent, Adremit Limited, Unit 5a, Commercial Yard,  
Settle, North Yorkshire, BD24 9RH

## Dimensions

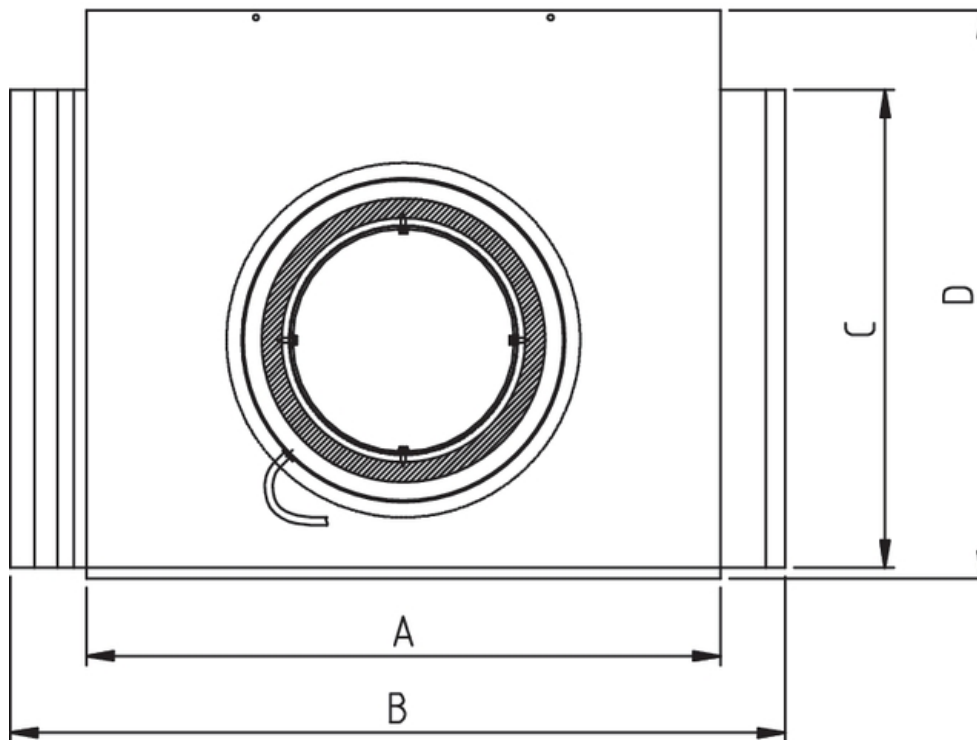
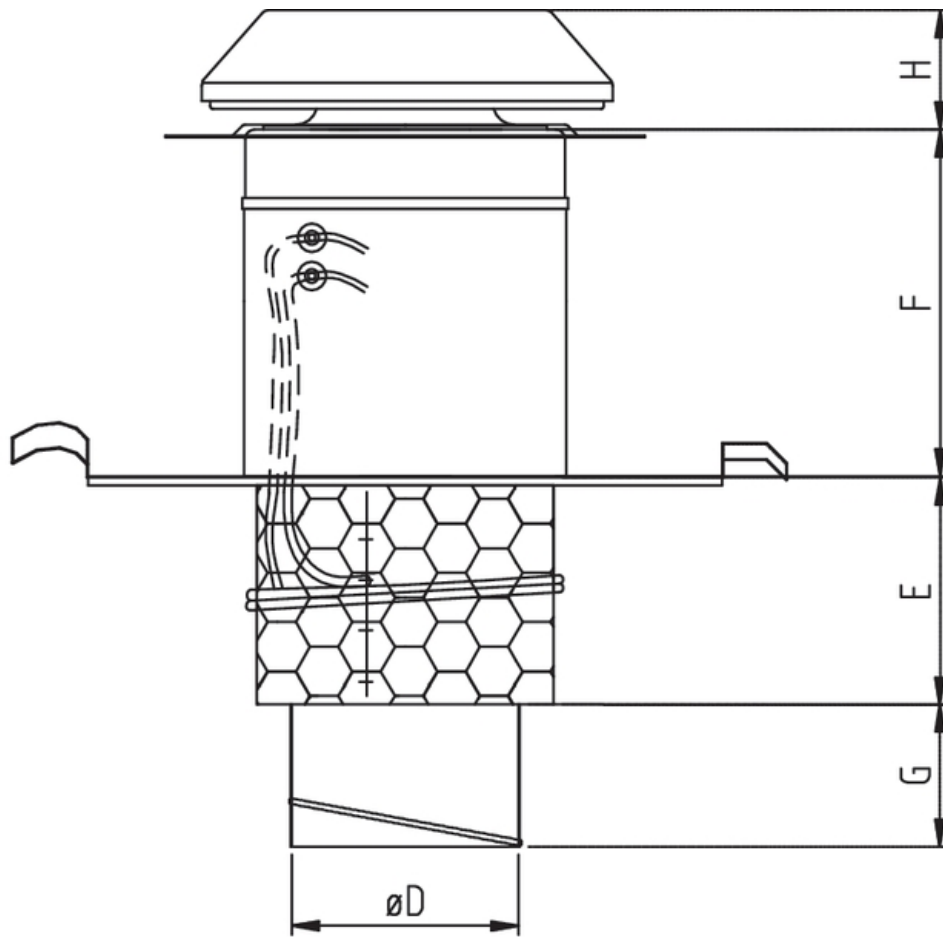

Name: **THB 200 HOOD W.COVER PL. BLACK** | Item no.: **134465**

Document type: **Product card** | Document date: **2019-06-05** | Generated by: **Online catalogue**

2 / 3

### Get In Touch



Call: [0845 6880112](tel:08456880112)



Email: [info@adremit.co.uk](mailto:info@adremit.co.uk)

### Our Address

Puravent, Adremit Limited, Unit 5a, Commercial Yard,  
Settle, North Yorkshire, BD24 9RH

THB	A	B	C	D	E	F	G	øD	H
160	260	375	-	448	95	305	217	160	91
200	560	684	430	500	200	305	125	200	95

### Accessories

### Documentation



TOB, TOS, THS, THB installation instruction\_205815\_CE\_A002.pdf (1,15MB)

### Specification text

Name: **THB 200 HOOD W.COVER PL. BLACK** | Item no.: **134465**

Document type: **Product card** | Document date: **2019-06-05** | Generated by: **Online catalogue**

3 / 3

#### Get In Touch



Call: [0845 6880112](tel:08456880112)



Email: [info@adremit.co.uk](mailto:info@adremit.co.uk)

#### Our Address

Puravent, Adremit Limited, Unit 5a, Commercial Yard,  
Settle, North Yorkshire, BD24 9RH