



TFSK 160 EC SILEO RED

Item no. 77258

Document type: **Product card**
 Document date: **2019-06-05**
 Generated by: **Systemair Online Catalogue**



Description

- High efficiency EC-motors
- 100 % speed controllable
- Swing-out

The TFSR EC and TFSK EC roof mounted fans are driven by EC motors and intended for use as extract fans in smaller premises such as self contained flats and apartments as well as storage areas, smaller work-rooms etc. EC-technology is intelligent technology, using integral electronic control to ensure that the motor always runs at optimal load and guarantees an effective utilisation of energy.

The fans are delivered with a pre-wired potentiometer (0-10V) that allows you to easily find the desired working point. The isolation switch is integrated and there are several alternative roof curbs available as accessories. The tilting mechanism simplifies cleaning and maintenance. To protect the motor from motor from overheating, the fans have integrated thermal contacts with automatic reset.

TFSR EC comes with circular base plate whilst the TFSK EC is provided with a square base frame. The horizontal discharge creates smaller internal pressure losses and prevents accumulation of ice on the roof. The protection guard prevents unintentional contact with the impeller. Both models are delivered with a connection box.

TFSR 125-160 are delivered with a Ø 160 spigot and TFSR 200-315 with a Ø 200. For cold climates we recommend that the fan runs continuously to avoid problems with ice.

In case of installing FSD-L flat roof socket, a TDA adapter is needed.



Technical parameters

Nominal data		
Voltage	230	V
Frequency	50/60	Hz
Phase	1	~
Input power (P1)	83,6	W
Current	0,699	A
Max. airflow	0,16	m³/s
R.p.m.	3340	r.p.m.
Weight	4,7	kg
Temperature data		
Max. temperature of transported air	60	°C
Max. temperature of transported air when speed-controlled	60	°C
Sound data		
Sound pressure level at 4 m	49,8	dB(A)
Sound pressure level at 10 m	41,8	dB(A)

Get In Touch

Call: [0845 6880112](tel:08456880112)
 Email: info@adremit.co.uk

Our Address

Puravent, Adremit Limited, Unit 5a, Commercial Yard,
 Settle, North Yorkshire, BD24 9RH



Protection / Classification

Insulation class	B
Enclosure class, motor	IP54

ErP

ErP ready	ErP 2016/ErP 2018
-----------	-------------------

Diagrams

Diagrams

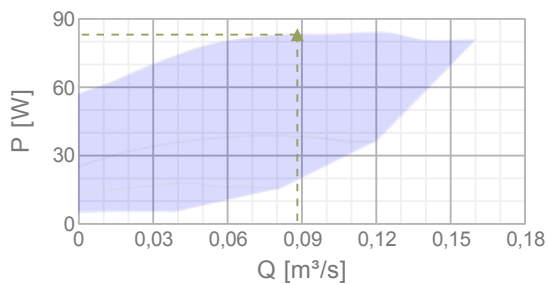
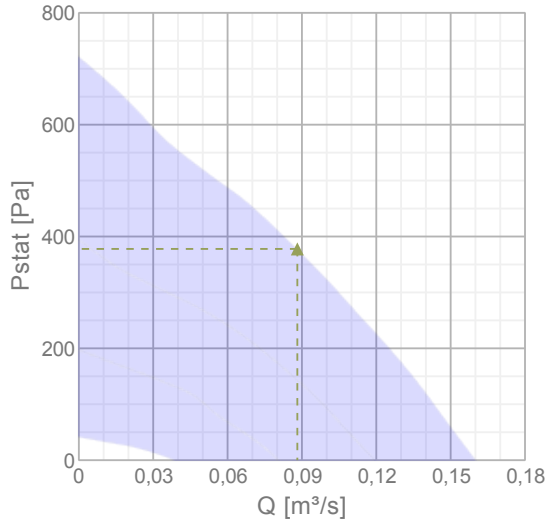

Max efficiency

Hydraulic data											
▲ Working air flow										0,0881 m³/s	
▲ Working static pressure										378 Pa	
▲ Power										83,1 W	
Speed										3349 r.p.m.	
Current										0,691 A	
SFP										0,943 W/(l/s)	
Voltage										230 V	
Sound power level			63	125	250	500	1k	2k	4k	8k	Tot
Inlet	dB(A)		36	50	55	59	64	63	64	61	70
Outlet	dB(A)		37	49	55	64	67	68	65	62	73

Name: **TFSK 160 EC SILEO RED** | Item no.: **77258**

Document type: **Product card** | Document date: **2019-06-05** | Generated by: **Online catalogue**

2 / 5

Get In Touch

 **Call:** 0845 6880112
 **Email:** info@adremit.co.uk

Our Address

Puravent, Adremit Limited, Unit 5a, Commercial Yard,
Settle, North Yorkshire, BD24 9RH

Dimensions

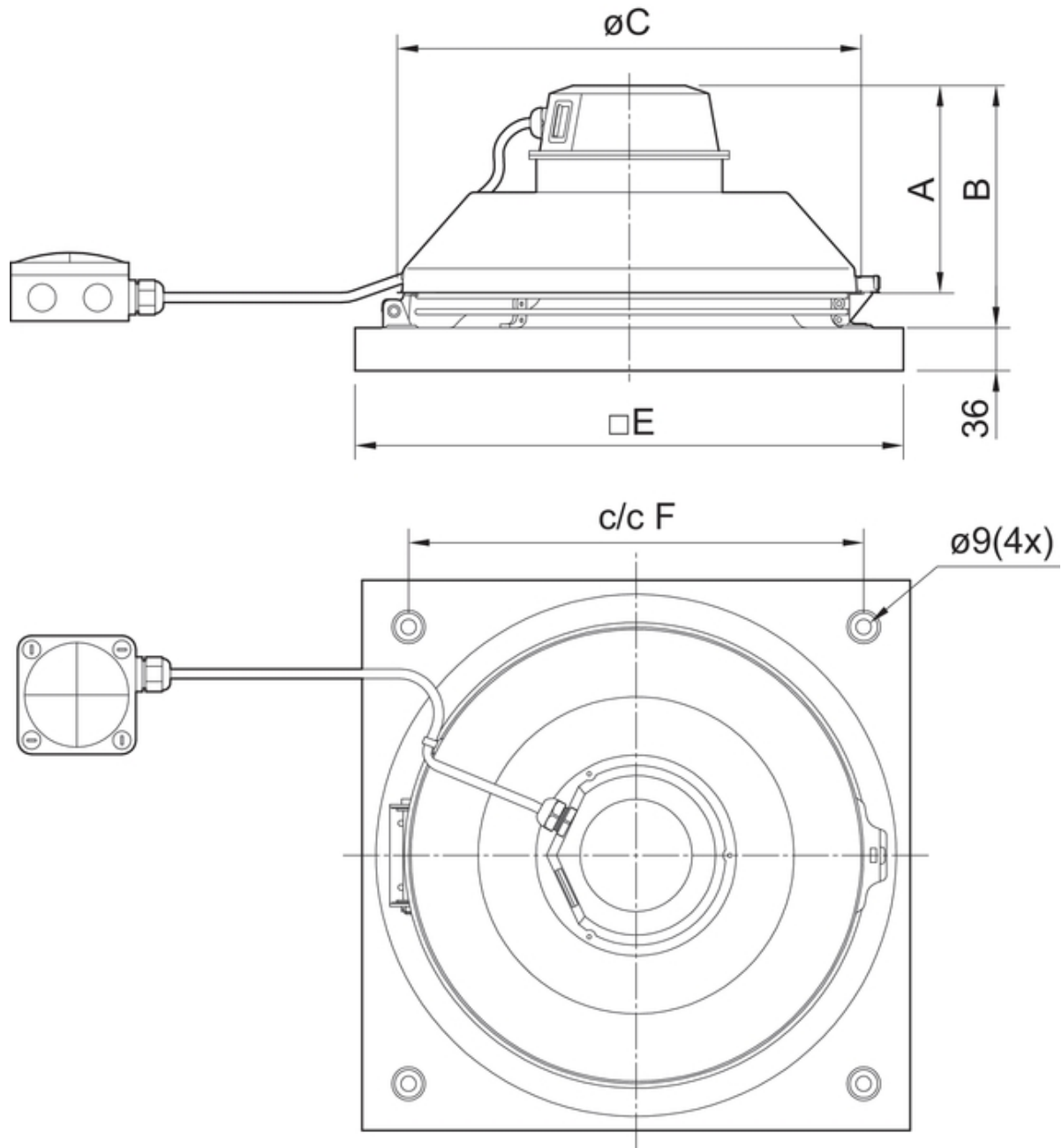



TFSK	A	B	$\varnothing C$	$\square E$	$c/c F$
160 EC	147	172	334	421	330
200 EC	150	187	364	421	330

Name: **TFSK 160 EC SILEO RED** | Item no.: **77258**

Document type: **Product card** | Document date: **2019-06-05** | Generated by: **Online catalogue**

3 / 5

Get In Touch

 Call: [0845 6880112](tel:08456880112)
 Email: info@adremit.co.uk

Our Address

Puravent, Adremit Limited, Unit 5a, Commercial Yard,
Settle, North Yorkshire, BD24 9RH

Wiring

230V 1~

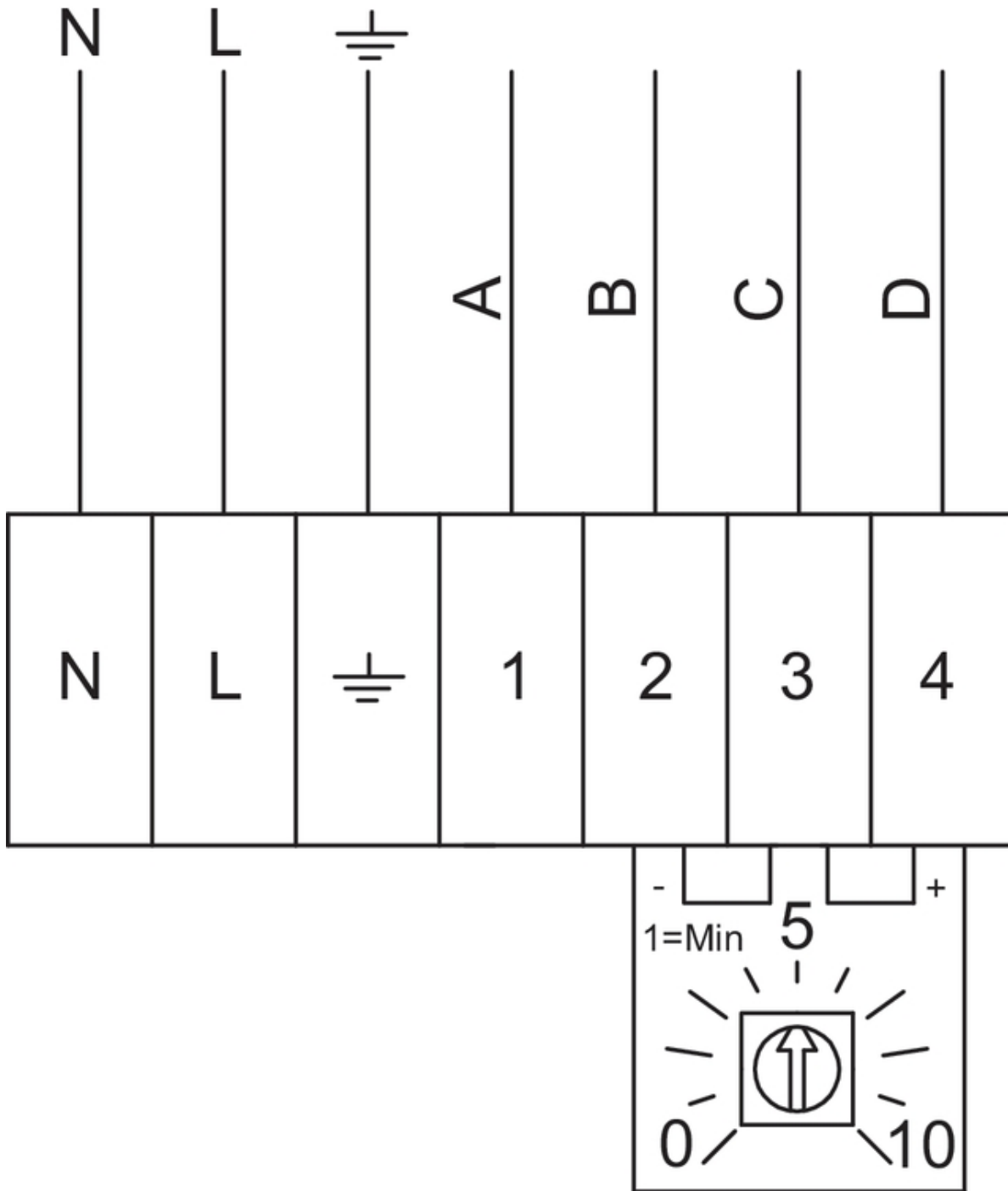

Terminal	Cable	Description
1	Black 1	Tacho output, Isink max 10mA
2	Black 2	GND
3	Black 3	Control input 0-10 VDC/PWM
4	Black 4	Output 10 VDC max 1.1 mA

Internal potentiometer, default

Name: **TFSK 160 EC SILEO RED** | Item no.: **77258**

Document type: **Product card** | Document date: **2019-06-05** | Generated by: **Online catalogue**

4 / 5

Get In Touch

Call: [0845 6880112](tel:08456880112)
Email: info@adremit.co.uk

Our Address

Puravent, Adremit Limited, Unit 5a, Commercial Yard,
Settle, North Yorkshire, BD24 9RH

Accessories

Electric accessories

[RT 0-30 Room Thermostat \(5151\)](#)
[CO2RT-R-D Transmitter \(6993\)](#)
[Presence detector/IR24-P \(6995\)](#)
[MTV-1/010 Controller 0..10V+ \(30650\)](#)
[DMD-C Pressure controller \(15793\)](#)
[MTP 10, 10K, Speed control \(32731\)](#)
[EC-Vent Room Unit \(3018\)](#)
[EC-Vent control board \(3115\)](#)
[MTP 20, on/off, 3-step \(310220\)](#)
[EC-Basic-H humidity \(24807\)](#)
[EC-Basic-T temperature \(24805\)](#)
[EC-Basic-U universal 0-10V \(24806\)](#)
[EC-Basic-CO2 and temperature \(24808\)](#)
[EC-Selector \(9908\)](#)
[CXE/AVC Modbus \(37256\)](#)
[S-5EC/FRQ \(76738\)](#)

Accessories

[LDC 160-600 Silencer \(5192\)](#)
[LDC 160-900 Silencer \(5193\)](#)
[TG 400-800 Roof curb \(1718\)](#)
[STG Connectionp.200 TG400-800 \(1765\)](#)
[BTG 400 Back Draft Damper \(5092\)](#)
[RSK-160 Back draft damper \(5601\)](#)
[VKS 310/311 Back draft damper \(9543\)](#)
[FDS 310/311 flat roof socket \(9549\)](#)
[VKM 310/311 Back draft damper \(9555\)](#)
[SSD 310/311 socket silencer \(9561\)](#)
[ASF 310/311 inlet flange DVS \(9568\)](#)
[ASS 310/311 flex. inl.con. DVS \(9575\)](#)
[ASK 310/311 inflow box SSD \(300904\)](#)
[TDA DV 310/311 Adapter \(301392\)](#)
[STG Connectionp.160 TG 400-800 \(4054\)](#)
[LDC 160-300 Silencer \(53108\)](#)
[FDS-L 310/311 flat roof socket \(95279\)](#)

Documentation

 [EC-fans_Operation_and_maintenance_instr_206268_CE_\(A022\).pdf \(2,88MB\)](#)

 [Bvd Takfläkt TFSK-TFSR Sileo, TFSK-TFSR EC Sileo ID7.pdf \(684,64kB\)](#)

Specification text

Roof fan, horizontal discharge, swing type. Casing and base frame made of galvanised steel sheet, powder-coated in black.

Free-running, backward curved, single-inlet centrifugal impeller made of plastic.
Balancing quality G 6.3, dynamically balanced acc. to DIN ISO 1940-1.

Energy-saving, energy-efficient external rotor motor EC, vibration-free mounted, the motor is placed inside the air flow for cooling. Integral thermal contacts internally connected with automatic reset.

Stepless control via 0-10V signal, internal potentiometer.

Terminal block with cable 1m, lead out from the motor. Service switch included (IP44).

For outdoor installation.

Vertical installation position.

Get In Touch



Call: [0845 6880112](tel:08456880112)



Email: info@adremit.co.uk

Our Address

Puravent, Adremit Limited, Unit 5a, Commercial Yard,
Settle, North Yorkshire, BD24 9RH