



# TFE 220 M ROOF FAN

Item no. 1269

Document type: **Product card**  
 Document date: **2019-06-11**  
 Generated by: **Systemair Online Catalogue**



## Description

- Speed controllable
- Tilting mechanism for easy servicing
- Maintenance-free and reliable
- Vertical exhaust

The TFE 220 has an impeller with backward-curved blades and maintenance-free external rotor motors. The casing is manufactured in powder-coated, galvanised sheet steel in the standard colours of black or brick red. These fans have integral mains circuit-breakers, and have a tilting mechanism for easy inspection and servicing. Exhaust air is directed vertically from the fans, which prevents problems caused by wet snow and staining of the roof.

To protect the motor from overheating, the TFE 220 has integral thermal contacts with electrical reset. These fans are suitable for use in exhaust-air ventilation systems, in single and multiple dwellings, offices and day nurseries.

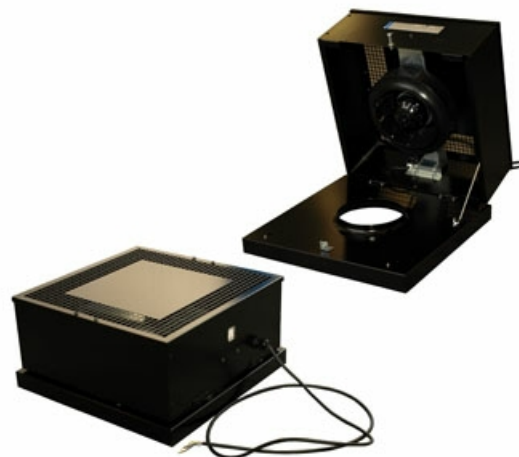

## Technical parameters

Default group	
Voltage	230 V
Frequency	50 Hz
Phase	1 ~
Input power (P1)	107 W
Current	0,468 A
Max. airflow	0,219 m³/s
R.p.m.	2602 r.p.m.
Max. temperature of transported air	70 °C
Max. temperature of transported air when speed-controlled	70 °C
Sound pressure level at 10 m	38,1 dB(A)
Weight	8 kg
Insulation class	B
Enclosure class, motor	IP44
Capacitor	3 µF
Colour	Black
ErP	
ErP ready	ErP 2016/ErP 2018
Energy class, basic unit	<b>E</b>
Energy class, basic unit option	<b>B</b>

### Get In Touch

Call: [0845 6880112](tel:08456880112)  
 Email: [info@adremit.co.uk](mailto:info@adremit.co.uk)

### Our Address

Puravent, Adremit Limited, Unit 5a, Commercial Yard,  
 Settle, North Yorkshire, BD24 9RH



## Accessories

### Electric accessories

[RE 1.5 Speed control \(5000\)](#)  
[REU 1.5 Speed control \(5004\)](#)  
[REE 1 Speed control \(5314\)](#)  
[REPT 6 Digital regulator \(5698\)](#)  
[RT 0-30 Room Thermostat \(5151\)](#)  
[CO2RT-R-D Transmitter \(6993\)](#)  
[Presence detector/IR24-P \(6995\)](#)  
[F251-16-60 Cookerhood transf \(5931\)](#)  
[RETP 6 Temp/Pressure regulator \(32293\)](#)  
[DTV200 \(6261\)](#)  
[F251-16-50 Cookerhood transf \(5930\)](#)  
[F251-16-70 Cookerhood transf \(5932\)](#)  
[DTV500A \(96807\)](#)

### Accessories

[LDC 200-600 Silencer \(5194\)](#)  
[LDC 200-900 Silencer \(5195\)](#)  
[TG 400-800 Roof curb \(1718\)](#)  
[STG Connectionp.200 TG400-800 \(1765\)](#)  
[BTG 400 Back Draft Damper \(5092\)](#)  
[RSK-200 Back draft damper \(5602\)](#)  
[STG Connectionp.125 TG 400-800 \(4053\)](#)  
[STG Connectionp.160 TG 400-800 \(4054\)](#)  
[LDC 200-300 Silencer \(53369\)](#)

## Diagrams

### Diagrams

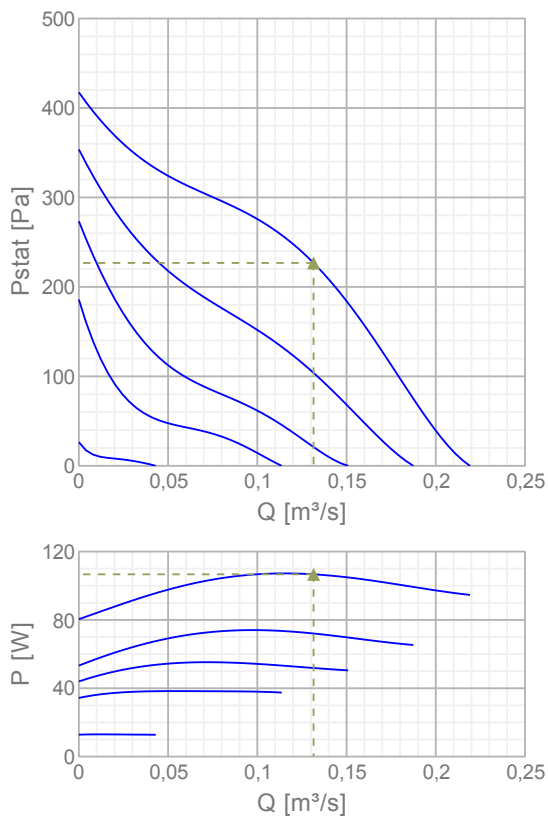

Name: **TFE 220 M ROOF FAN** | Item no.: **1269**

Document type: **Product card** | Document date: **2019-06-11** | Generated by: **Online catalogue**

2 / 4

### Get In Touch

 **Call:** [0845 6880112](tel:08456880112)  
 **Email:** [info@adremit.co.uk](mailto:info@adremit.co.uk)

### Our Address

Puravent, Adremit Limited, Unit 5a, Commercial Yard,  
Settle, North Yorkshire, BD24 9RH

## Max efficiency

Hydraulic data										
▲ Working air flow										0,132 m <sup>3</sup> /s
▲ Working static pressure										227 Pa
▲ Power										107 W
Speed										2603 r.p.m.
Current										0,467 A
SFP										0,811 W/(l/s)
Voltage										230 V
Sound power level		63	125	250	500	1k	2k	4k	8k	Tot
Inlet	dB(A)	39	53	59	64	65	60	55	46	69
Outlet	dB(A)	34	39	57	65	63	59	53	44	68

## Dimensions

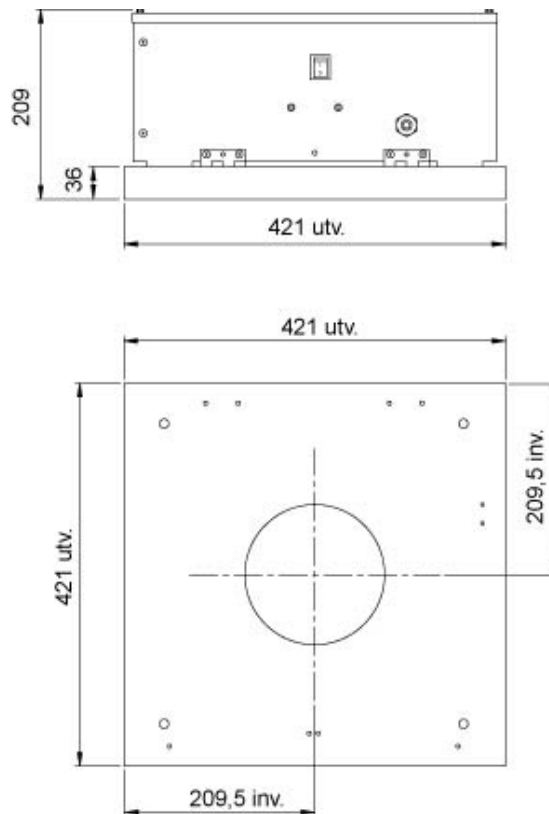

### Get In Touch

Call: [0845 6880112](tel:08456880112)  
 Email: [info@adremit.co.uk](mailto:info@adremit.co.uk)

### Our Address

Puravent, Adremit Limited, Unit 5a, Commercial Yard,  
 Settle, North Yorkshire, BD24 9RH

## Wiring

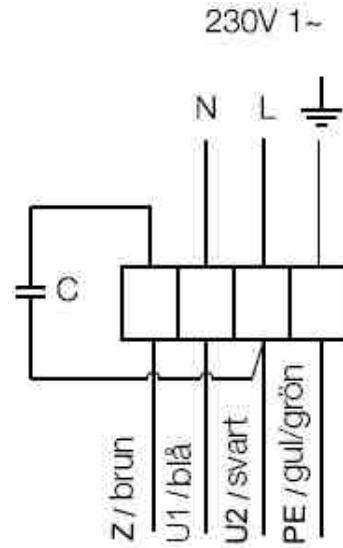

## Documentation

 SEMKO Certificate TFE 1211219.pdf (1,14MB)

 202341\_Fans\_Instructions\_CE\_A010.pdf (1,83MB)

## Energy class label

Energy class, basic unit

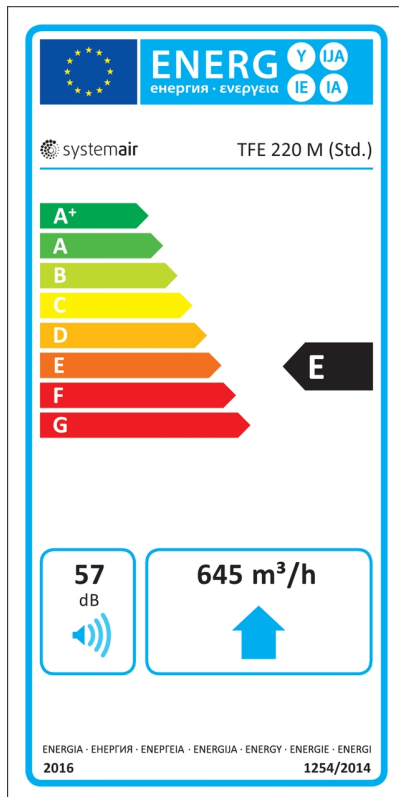

## Specification text

Name: **TFE 220 M ROOF FAN** | Item no.: **1269**

Document type: **Product card** | Document date: **2019-06-11** | Generated by: **Online catalogue**

4 / 4

## Get In Touch

 Call: [0845 6880112](tel:08456880112)  
 Email: [info@adremit.co.uk](mailto:info@adremit.co.uk)

## Our Address

Puravent, Adremit Limited, Unit 5a, Commercial Yard,  
Settle, North Yorkshire, BD24 9RH