

MUB/T 062 500D4

Centrifugal box fan, 120°C continuous, insulated

Item Number: 235442

Variant: 400V 3~ 50Hz

- Up to 120°C medium temperature, continuous operation
- Multi-functional use, e.g. for kitchen exhaust air
- Modular system
- Integral cold conductor (PTC)
- Pre-assembled isolator is standard
- Low sound level
- Easy to maintain and reliable
- High efficient motors
- Speed-controllable via frequency converter
- Motor outside the air stream





All MUB/T fans have impellers with backward curved blades, manufactured from aluminium, and IEC standard motors outside the air stream for all 400V three phase motors from 0.75 kW. The MUB/T fans are suitable for medium temperatures up to 120°C continuously. Motor protection by cold conductors (PTC), to be connected to an external motor protection device.

The casing consists of an aluminium frame with fibreglass reinforced plastic corners and double skin, galvanised steel panels with a 30 mm mineral wool insulation. Panels are removable, allowing flexible ventilation solutions - the air direction can easily be changed. With quick lock access door. The MUB/T bottom panel is shaped as a condensate tray and incorporates a pre-mounted 1" drain plug. An isolator switch is mounted on the casing. Several filter modules like f.e. activated carbon- or aluminum filters are available, calculated individually on the working point.

Technical parameters

Nominal data		
Voltage (nominal)	400	V
Frequency	50	Hz
Phases	3~	
Input power	1,418	W
Input current	2.99	A
Impeller speed	1,464	rpm
Air flow	max 2.386	m³/s
Temperature of transported air	max 120	°C
Max temperature of transported air, when speed controlled	120	°C
Protection/Classification		
Enclosure class, motor	IP55	
Insulation class	F	

Get In Touch

 **Call:** 0845 6880112
 **Email:** info@adremit.co.uk

Our Address

Puravent, Adremit Limited, Unit 5a, Commercial Yard,
 Settle, North Yorkshire, BD24 9RH

Dimensions and weights

Weight	90.5 kg
--------	---------

Others

Motor type	AC
------------	----

Get In Touch

 **Call:** [0845 6880112](tel:08456880112)
 **Email:** info@adremit.co.uk

Our Address

Puravent, Adremit Limited, Unit 5a, Commercial Yard,
Settle, North Yorkshire, BD24 9RH

Performance

Performance curve

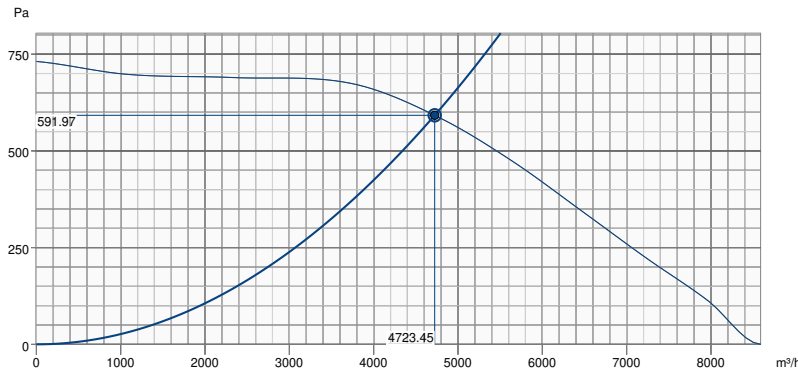

Hydraulic data

Required air flow	4723.69 m³/h
Required static pressure	592 Pa
Working air flow	4723.45 m³/h
Working static pressure	592 Pa
Air density	1.204 kg/m³
Power	1416.6 W
Fan control - RPM	1464 rpm
Current	3.00 A
SFP	1.080 kW/m³/s
Control voltage	400.0 V
Supply voltage	400 V

Sound power level		63	125	250	500	1k	2k	4k	8k	Total
Inlet	dB(A)	44	67	68	71	73	70	68	59	78
Outlet	dB(A)	45	69	70	72	74	71	69	60	79
Surrounding	dB(A)	22	49	42	42	43	43	35	23	52
Sound pressure level at 3m (20m² Sabine)	dB(A)	-	-	-	-	-	-	-	-	45
Sound pressure level at 3m free field	dB(A)	-	-	-	-	-	-	-	-	31

Article name: MUB/T 062 500D4 | Product link: <https://shop.systemair.com/en-GB/productPermalink?p=522959> | Item Number: 235442 | Variant: 400V 3~ 50Hz | Document type: Product card | Created at: 03.11.2022 | Generated by: Systemair Online Catalogue | Language: English

Get In Touch

Call: 0845 6880112
Email: info@adremit.co.uk

Our Address

Puravent, Adremit Limited, Unit 5a, Commercial Yard,
Settle, North Yorkshire, BD24 9RH



Dimension

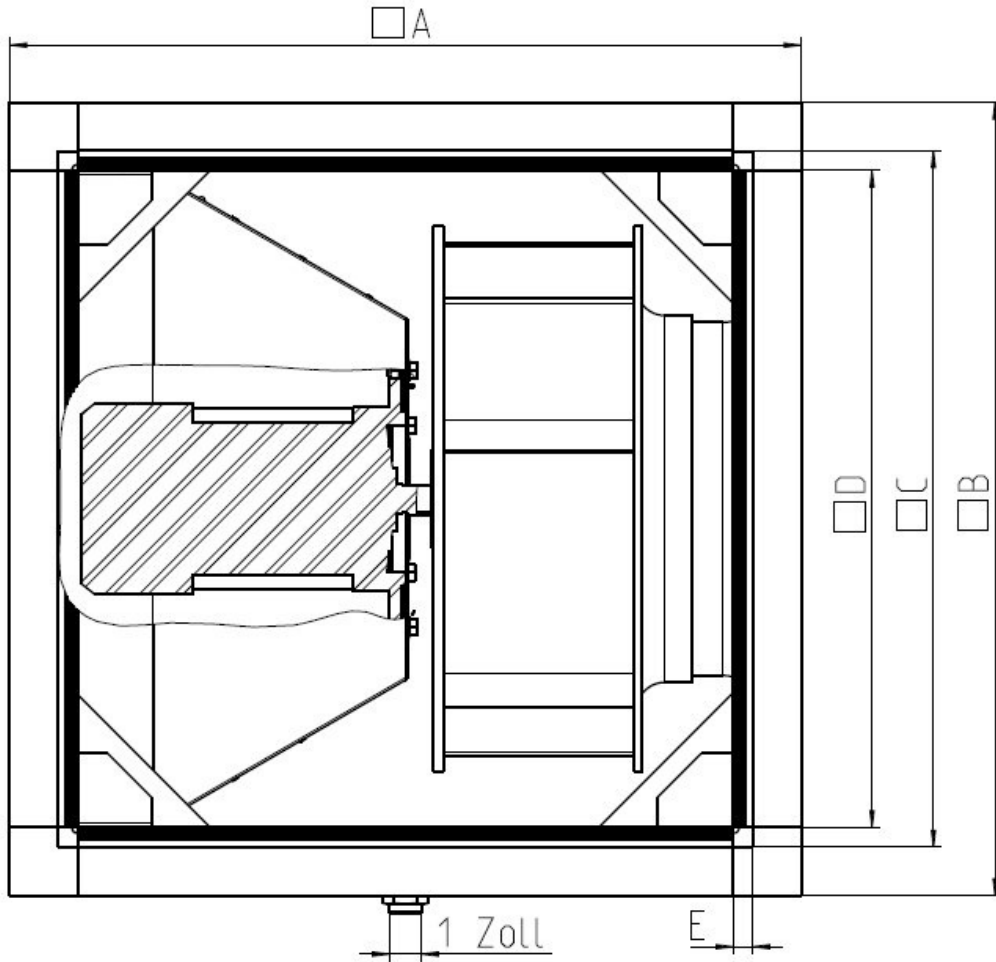

MUB/T 062	□A	□B	□C	□D	E
500/560/630	820	820	720	678	21



Article name: MUB/T 062 500D4 | Product link: <https://shop.systemair.com/en-GB/productPermalink?p=522959> | Item Number: 235442 | Variant: 400V 3~ 50Hz | Document type: Product card | Created at: 03.11.2022 | Generated by: Systemair Online Catalogue | Language: English

Page 4 of 7

Get In Touch

 Call: 0845 6880112
 Email: info@adremit.co.uk

Our Address

Puravent, Adremit Limited, Unit 5a, Commercial Yard,
Settle, North Yorkshire, BD24 9RH

Wiring

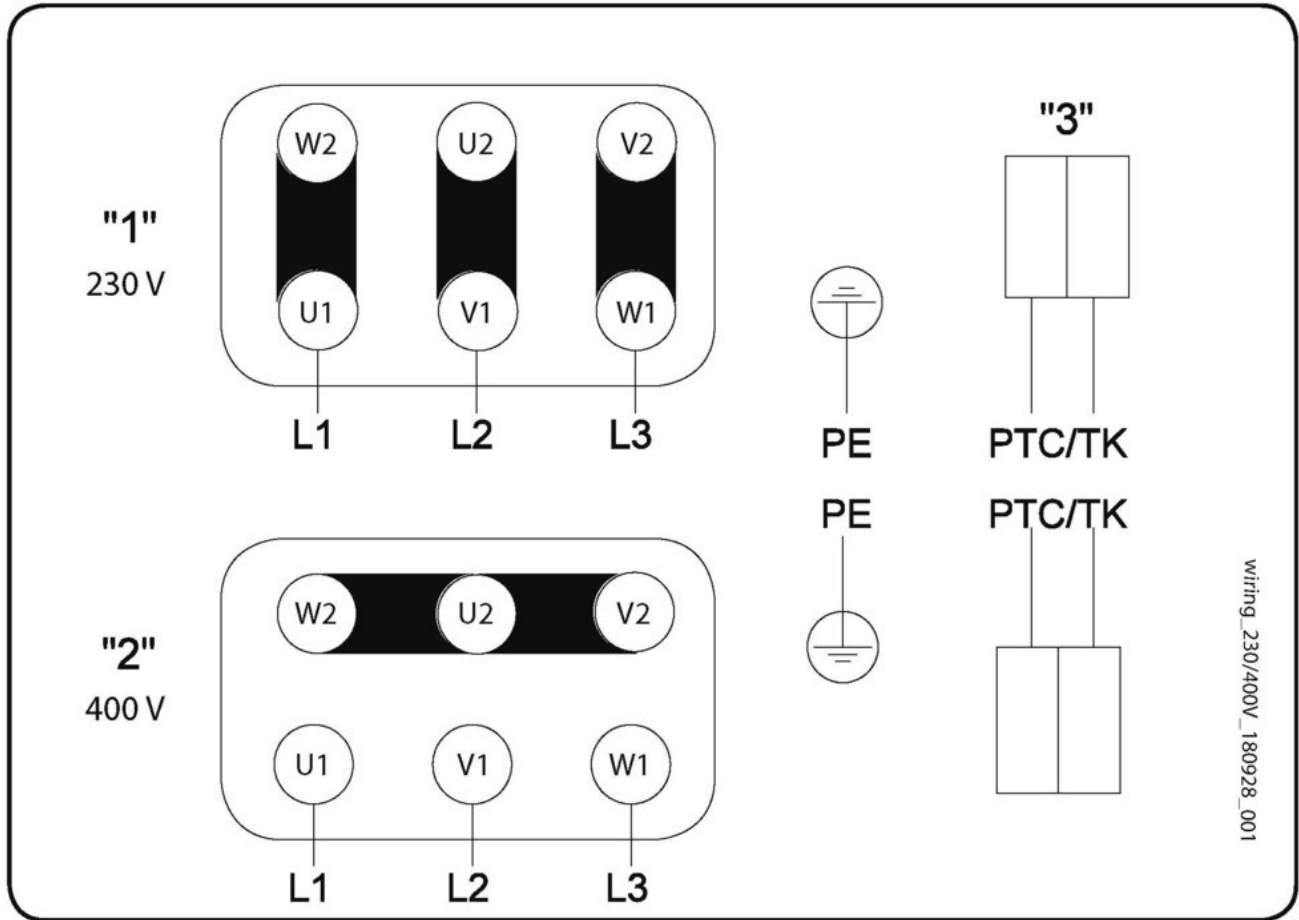

- 1 3 x 230V Delta Connection
 - 2 3 x 400V Star connection
 - 3 PTC / TK
- Changing of direction of rotation by interchanging of two phases

Get In Touch

Call: 0845 6880112
Email: info@adremit.co.uk

Our Address

Puravent, Adremit Limited, Unit 5a, Commercial Yard,
Settle, North Yorkshire, BD24 9RH



Acoustic

The Level of Casing-Breakout-Noise depends on the quality of shielding the acoustic inlet and outlet noises.

The shown Level of Casing-Breakout-Noise will be reached only in case of 100 % shielding the acoustic inlet and outlet noise and a correspondingly low environment noise.

Get In Touch



Call: [0845 6880112](tel:08456880112)



Email: info@adremit.co.uk

Our Address

Puravent, Adremit Limited, Unit 5a, Commercial Yard,
Settle, North Yorkshire, BD24 9RH

Accessories

- FGV 062/716-716 flex. conn. (4198)
- Frequency converter FRQ5-4A (36229)
- Frequency converter FRQS-4A (36231)
- M-SG 062/718x718 (301346)
- TUNE-AHU-DE008-062-718x718-M0 (79882)
- UGS 062/500 adapter flex 120°C (38370)
- UGS 062/630 adapter flex. (4358)
- WSG 062 MUB/T complete (36067)
- CCM inlet MUB062 d560 (311782)
- CCM outlet MUB062 d560 (311684)
- CCMI outlet 062 d560 KIT 30mm (239095)
- GRU 062 base frame h= 100mm (276662)
- KKF-ALU 062-filter-section (376816)
- KKF-CAR 100-filter-section (277348)
- KKF-KITCHEN 100-filter-section (277367)
- Frequency converter FRQ-4A (36227)
- Frequency converter FRQ5S-4A (36233)
- Frequency converter FXDM5AM (31387)
- SD-MUB Vibration pad set (37324)
- U-EK230E Motor protection (30199)
- UGS 062/630 adapter flex 120°C (38371)
- WSD 062 (860x860x70) complete (31482)
- FGV 062/716-716 flex. 120°C (38362)
- CCM inlet MUB062 d630 (311783)
- CCM outlet MUB062 d630 (311681)
- CCMI outlet 062 d630 KIT 30mm (239096)
- KKF 30 062-filter-section (93312)
- KKF-CAR 062-filter-section (277347)
- KKF-KITCHEN 062-filter-section (277364)
- KKS 062 silencer-section (276852)

Documents

- Installation, Operation and Maintenance instruction_001
- UKCA DECLARATION OF CONFORMITY_THERMOFANS_EN_002.PDF
- COMMISSIONING REPORT_FANS_160628_EN_001.PDF

Get In Touch

- 📞 Call: [0845 6880112](tel:08456880112)
- ✉ Email: info@adremit.co.uk

Our Address

Puravent, Adremit Limited, Unit 5a, Commercial Yard,
Settle, North Yorkshire, BD24 9RH