

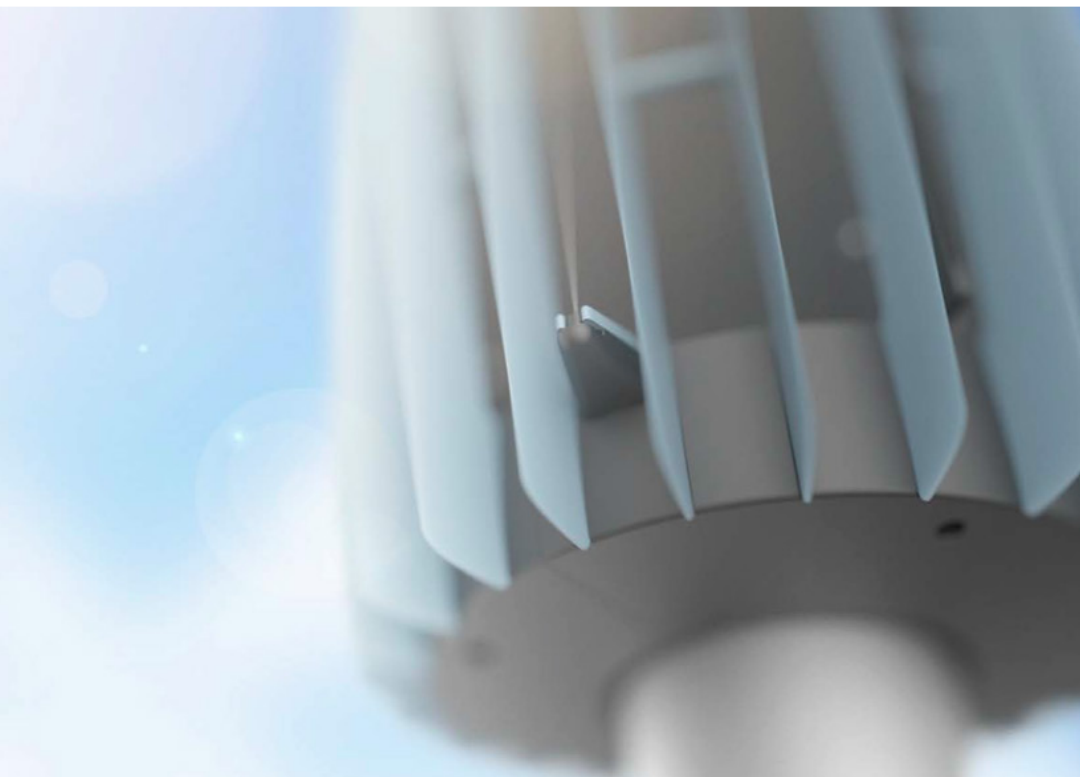

STATIC AIR

FINE DUST FREE





PMX

Particulate Matter Reduction System

www.staticair.com

Get In Touch

 Call: [0845 6880112](tel:08456880112)
 Email: info@adremit.co.uk

Our Address

Puravent, Adremit Limited, Unit 5a, Commercial Yard,
Settle, North Yorkshire, BD24 9RH





StaticAir

Fine dust: a matter that is elusive to many, can only be measured by some and can be captured by very little. StaticAir offers a revolutionary solution.

The capture of fine dust is done by StaticAir on the basis of a number of unique patents. In recent years, a series of products has been developed for both the indoor and outdoor environment based on these patents. StaticAir's fine dust reduction systems are easy to use and have a very low energy requirement.

The dozens of field tests, which took place during the development of the products, gave a lot of insight into the capturing of fine dust and the configuration of the systems.

StaticAir is a part of Mark Climate Technology. Mark is specialist in indoor climate control and brings over 70 years of international experience.

StaticAir's mission is to create a fine-dust free living and working environment.



Get In Touch



Call: [0845 6880112](tel:08456880112)



Email: info@adremit.co.uk

Our Address

Puravent, Adremit Limited, Unit 5a, Commercial Yard,
Settle, North Yorkshire, BD24 9RH

Fine dust and the effects on your health

Fine dust is a form of air pollution. Airborne particles that are smaller than 10 micrometers (0.01 mm) are considered to be fine dust. These fine dust particles differ in size, origin and chemical composition. On the basis of the size, fine dust is called PM₁₀, PM_{2.5}, or PM_{0.1} (ultra-fine dust). The composition of fine dust is very variable. Common components of fine dust include metals, carbon (soot), salt and nitrate.

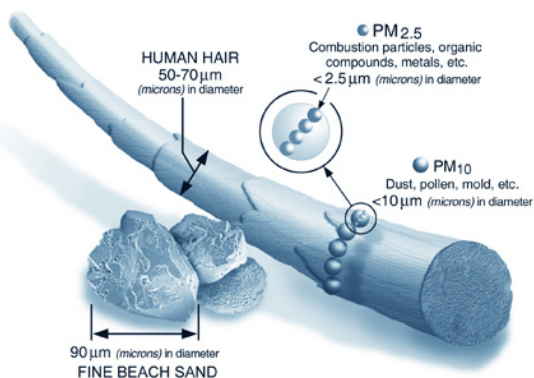

Research data shows that fine dust is harmful to health. According to the RIVM, the average life expectancy due to short-term and long-term exposure to fine dust is decreasing by about a year. Because of the harmful effects on health, the European Union and the World Health Organization have set limit values for fine dust (PM₁₀ and PM_{2.5}). These limit values are exceeded in many places. For example, along busy roads, industrial areas

and cattle farms, but also in many workshops and in the indoor environment, a dangerous high concentration of fine dust is created through work processes. Fine dust is not only at the source but also far away from it, it can cover up to 40km.

Small floating particles enter the lungs by inhalation. Particles larger than 10 micrometers are still filtered through the nose and excreted via the mucous membrane. But smaller fine dust penetrates deep into the lungs and damages them. Ultra-fine dust even penetrates into the bloodstream. These small particles can cause inflammatory reactions and make oxygen uptake more difficult. In addition, fine dust increases the risk of a heart attack and lung cancer. Neurological effects of fine dust have also been found, as a result of which the cardiac muscle functions can be negatively influenced. In people with respiratory diseases and cardiovascular diseases, exposure to fine dust worsens their symptoms. In addition to premature death, fine dust also plays an important role in cases of illness. Exposure to fine dust causes an increase in hospital admissions, complaints and absenteeism at work. Chronic exposure to fine dust increases the chance of the negative effects mentioned.

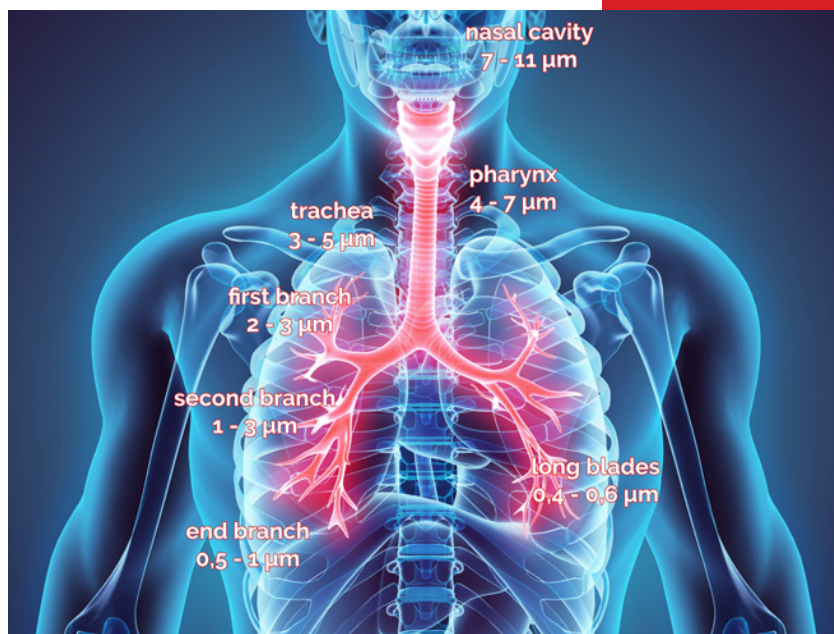

Get In Touch

Call: 0845 6880112
Email: info@adremit.co.uk

Our Address

Puravent, Adremit Limited, Unit 5a, Commercial Yard, Settle, North Yorkshire, BD24 9RH



Operation of the PMX

The PMX reduces fine dust in the immediate vicinity. The PMX contains corona wires to which a positive high voltage is applied. This is a direct current voltage with a low current. The PMX is safe for humans and animals. The fine dust in the vicinity of the PMX is ionized by the charge of the corona wires and is attracted by a grounded plate in the PMX. Due to the corona operation, an electric wind is created from the corona wire to the earthed plate. This action ensures that the fine dust is attracted and deposited on the grounded plate, without the use of ventilation.

The PMX can reduce up to 50% in the interior with just 18 watts. The energy supply takes place via the normal electricity grid. The PMX is unique in actually capturing fine dust in an economical and sustainable way.

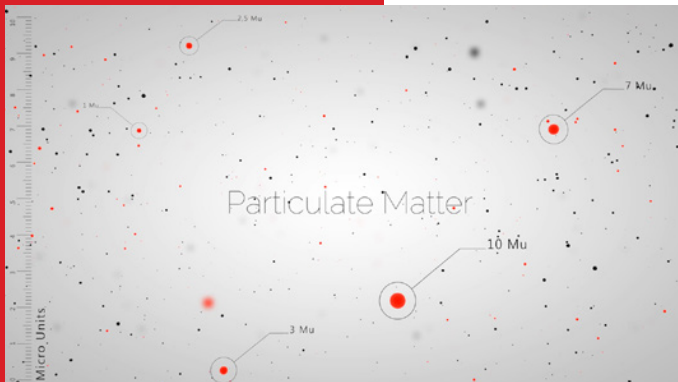

1. Polluted outside air

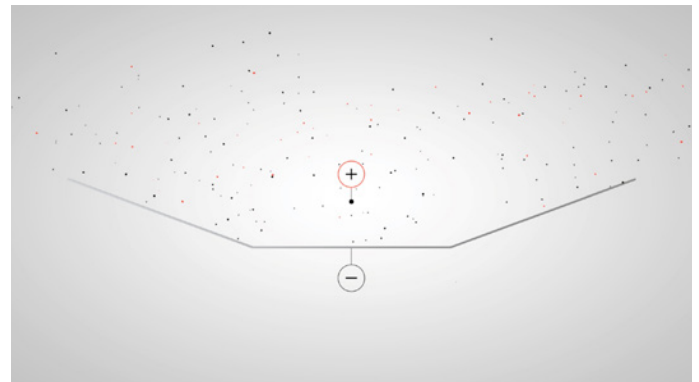

2. Positively charged wire and grounding plate

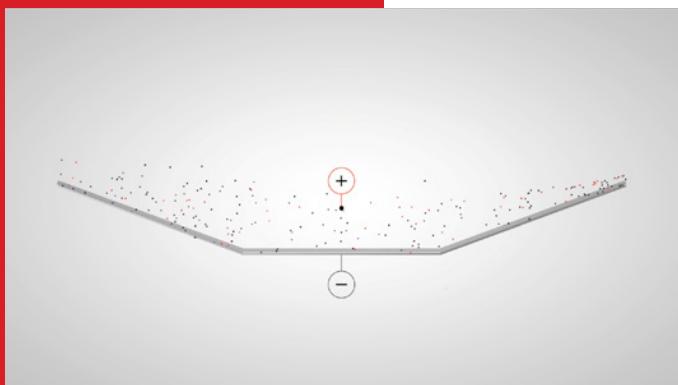

3. System on

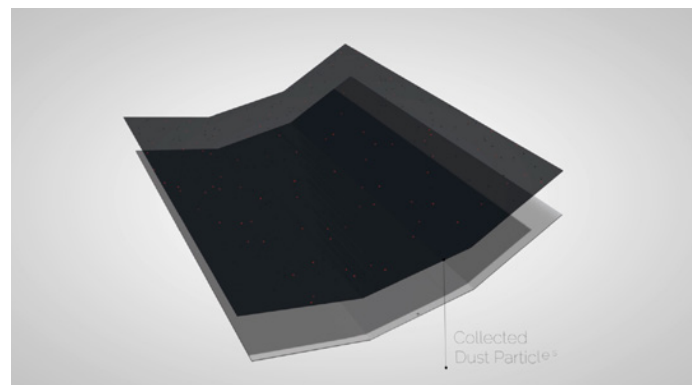

4. Gathered dust

Get In Touch



Call: [0845 6880112](tel:08456880112)



Email: info@adremit.co.uk

Our Address

Puravent, Adremit Limited, Unit 5a, Commercial Yard, Settle, North Yorkshire, BD24 9RH





Features PMX

- Up to 50% particulate matter reduction in the indoor environment *
- Reduces all types of fine dust, such as: exhaust fumes, building material, metallic substance, etc
- Reduces all sizes of (ultra-) fine dust $PM_{0.1}$ to PM_{10}
- Simple control with LED indication
- Contributes to a healthy living and working environment
- Energy-efficient
- Quiet
- Safe for humans and animals
- No moving parts
- Easy to install
- Easy to operate
- Modular construction
- Low maintenance
- Smart City ready

* depending on environmental conditions

Get In Touch

 Call: [0845 6880112](tel:08456880112)
 Email: info@adremit.co.uk

Our Address

Puravent, Adremit Limited, Unit 5a, Commercial Yard,
Settle, North Yorkshire, BD24 9RH



Specifications

Structure

- Configuration: cylinder
- Height: 2270 mm
- Diameter: 650 mm
- Weight: +/- 50 kg

Specifications

- Low power consumption: 18 watts
- Plastic casing
- Power supply: 230V / 110V
- IP rating: IP 65

Optional

- Link with management system:
 - via I / O contacts
 - via LoRa (wireless)
- Customized color possible
- Customer-specific wishes possible

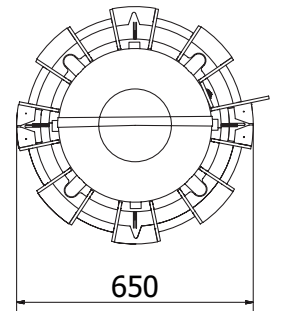
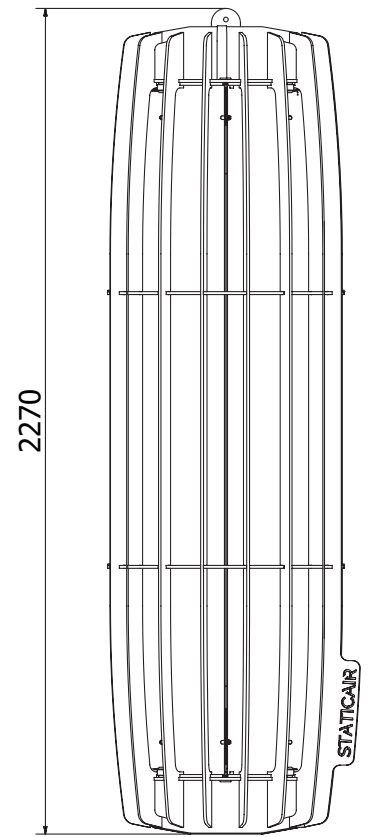

Get In Touch

-  Call: [0845 6880112](tel:08456880112)
 Email: info@adremit.co.uk

Our Address

Puravent, Adremit Limited, Unit 5a, Commercial Yard,
Settle, North Yorkshire, BD24 9RH



Application areas

StaticAir's fine dust reduction systems have been extensively tested in various environments and conditions. The operation has been validated by independent third parties. In collaboration with Rijkswaterstaat, TNO, Delft University of Technology, municipality and province, significant fine dust reduction has been demonstrated in the tunnel environment, the outdoor environment and the laboratory. In addition, StaticAir has years of experience with fine dust reduction in various industries in Europe and beyond. StaticAir's fine dust reduction systems are suitable for applications in, among others:

Outdoor environment:

- Street Canyon environment
- Traffic control systems
- Parks and recreational areas
- Tunnels

Indoor environment:

- Parking garage
- Construction hall
- Agriculture intensive livestock farming
- Boulderhall / climbing hall
- Ceramic industry
- Concrete industry
- Glass industry
- Recycling industry
- Metal industry

Get In Touch



Call: [0845 6880112](tel:08456880112)



Email: info@adremit.co.uk

Our Address

Puravent, Adremit Limited, Unit 5a, Commercial Yard,
Settle, North Yorkshire, BD24 9RH

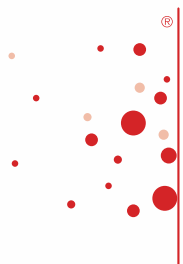

STATIC AIR

FINE DUST FREE

De Aaldor 28
4191 PC Geldermalsen
The Netherlands

T +31 (0)345 – 745 920
I www.staticair.com
E info@staticair.com



Adremit Limited,
Unit 5A, Commercial Courtyard,
Settle, North Yorkshire. BD24 9RH



+44 (0)845 6880112
info@puravent.co.uk
www.puravent.co.uk

Get In Touch

 Call: [0845 6880112](tel:08456880112)
 Email: info@adremit.co.uk

Our Address

Puravent, Adremit Limited, Unit 5a, Commercial Yard,
Settle, North Yorkshire, BD24 9RH

