

Issue: 1  
 Issue Date: 180512

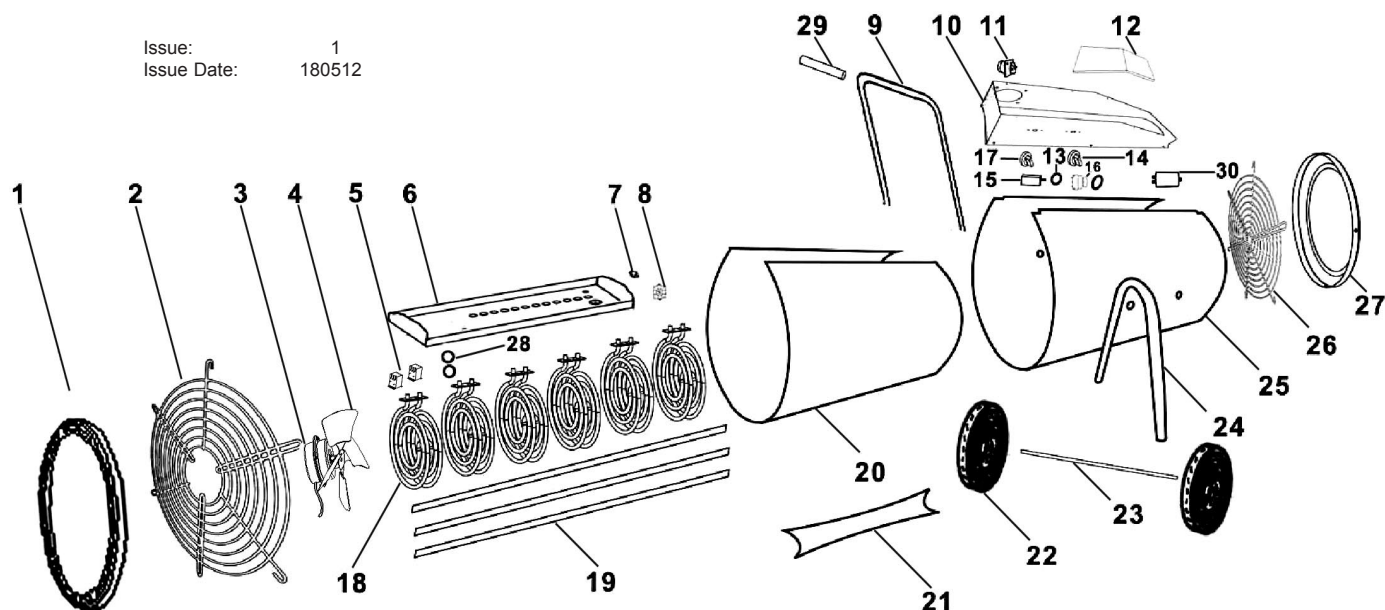

ITEM	PART NO	DESCRIPTION	ITEM	PART NO	DESCRIPTION
1	EH30001.01	COVER FOR GRILLE	16	EH30001.16	THERMOSTAT
2	EH30001.02	GRILLE	17	EH30001.17	SWITCH KNOB
3	EH30001.03	MOTOR	18	EH30001.18	HEATING ELEMENT
4	EH30001.04	FAN	19	EH30001.19	HEATING ELEMENT SUPPORT
5	EH30001.05	SENSOR	20	EH30001.20	INNER CASING
6	EH30001.06	HEATING ELEMENT SUPPORT	21	EH30001.21	CONNECT PLATE
7	EH30001.07	TIME- DELAY THERMOSTAT	22	EH30001.22	WHEEL
8	EH30001.08	THERMAL CUT-OFF	23	EH30001.23	WHEEL AXLE
9	EH30001.09	HANDLE	24	EH30001.24	FOOT SUPPORT
10	EH30001.10	CONTROL BOX	25	EH30001.25	OUTER CASING
11	EH30001.11	SOCKET	26	EH30001.26	BACK GRILL
12	EH30001.12	CONTROL BOX COVER	27	EH30001.27	COVER FOR BACK GRILL
13	EH30001.13	WATERPROOF RING	28	EH30001.28	INSULATION RING
14	EH30001.14	THERMOSTAT KNOB	29	EH30001.29	HANDLE GRIP
15	EH30001.15	SWITCH	30	EH30001.30	CAPACITOR

**NOTE:** It is our policy to continually improve products and as such we reserve the right to alter data, specifications and component parts without prior notice.

**IMPORTANT:** No liability is accepted for incorrect use of product.

**WARRANTY:** Guarantee is 12 months from purchase date, proof of which will be required for any claim.

**INFORMATION:** For a copy of our latest catalogue and promotions call us on 01284 757525 and leave your full name and address, including postcode.