



SSS 560 SLANT. SOCKET SILENCER

Item no. 30079

Document type: **Product card**
 Document date: **2019-06-20**
 Generated by: **Systemair Online Catalogue**

Description

Roof socket with silencer for slanted roof

Socket silencer for special requirements at the inlet side. Manufactured from seawater resistant aluminium. The sound absorption at 250 Hz is in average 8 dB. The sound absorbing material is abrasion resistant up to a velocity of 20 m/s. The crank is extendable for service options.

Suitable for DVS/DHS, DVSI, DVN, DVNI, DVC, TFSK and DVEX.



Dimensions

	D	E	F	H	nut M1	h7~	weight (kg)	
							$\alpha = 10^\circ$	$\alpha = 30^\circ$
SSS 190*	245	294	571	258	M6	400	6	6
SSS 310**	330	395	710	345	M6	500	9	9
SSS 355	450	555	874	505	M10	650	18	19
SSS 450	535	625	900	565	M10	650	19	20
SSS 560	750	895	1200	835	M10	700	33	36
SSS 710	840	985	1300	925	M10	800	43	47

* also suitable for TFSK 125 M/L

** also suitable for TFSK 160 and 200

Weights only for 10° respectively 30° roof angle for information only.

At order it is necessary to know the roof angle α (from 1° to 45°)!

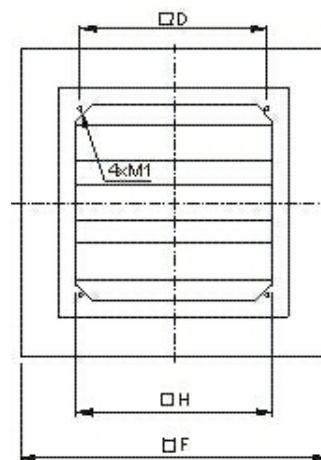
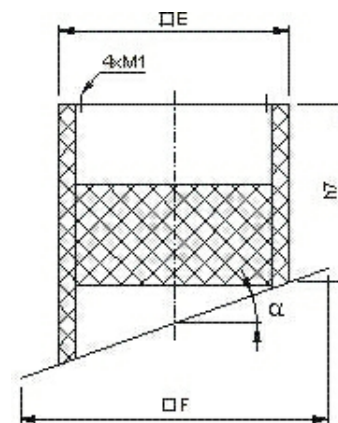

Get In Touch

Call: [0845 6880112](tel:08456880112)
 Email: info@adremit.co.uk

Our Address

Puravent, Adremit Limited, Unit 5a, Commercial Yard,
 Settle, North Yorkshire, BD24 9RH



Diagram

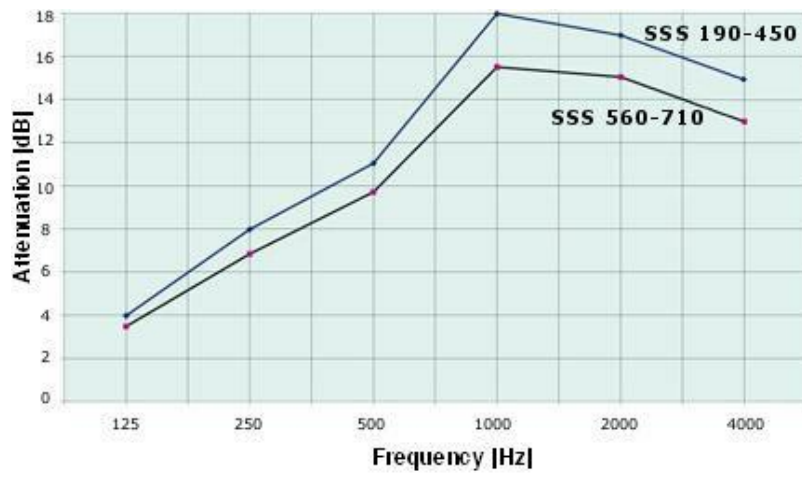
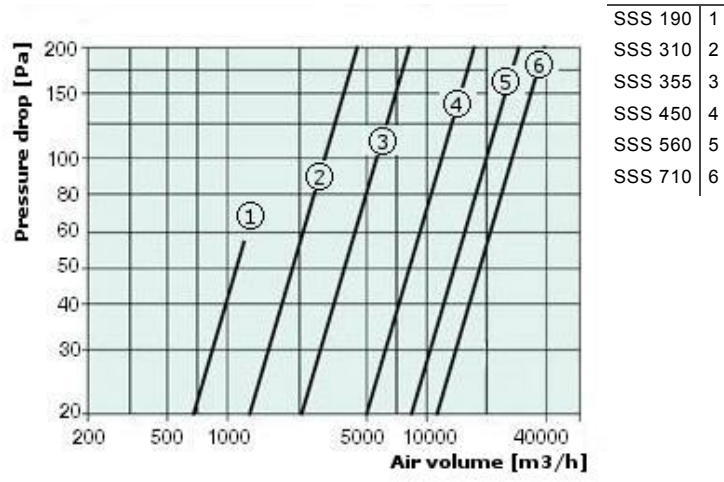

Specification text

Name: **SSS 560 SLANT. SOCKET SILENCER** | Item no.: **30079**

2 / 2

Document type: **Product card** | Document date: **2019-06-20** | Generated by: **Online catalogue**

Get In Touch

Call: [0845 6880112](tel:08456880112)
 Email: info@adremit.co.uk

Our Address

Puravent, Adremit Limited, Unit 5a, Commercial Yard,
 Settle, North Yorkshire, BD24 9RH