



## SPM-315 IRIS DAMPER WITH BULB

Item no. 6255

Document type: **Product card**

Document date: **2019-06-20**

Generated by: **Systemair Online Catalogue**

### Description

Systemair SPM iris damper with more choking ability.

#### Function

The SPM is an iris damper for measuring and adjusting the air flow, with more choking ability than the SPI. The SPM has the following specifications: low noise level, centrallyformed air flow and fixed test points for precise measurements. Accessorie, Access door RLL, is recommended for use with SPM. Available in sizes  $\varnothing$  160-400, but not for size 300.

#### Design

The damper is manufactured from galvanised sheet steel and is fitted with an air-tight rubber seal. Size  $\varnothing$  160-400.

#### How to use for exhaust air

This device can be used for exhaust air.

#### Mounting

The SPM adjustment damper must be installed in accordance with the distances required to minimise air-flow deviation. Reducing or enlarging the duct to the next duct size does not require any specified distances for minimising deviation. The SPM enables the taking of precise air-flow measurements at all points including points close to duct deviations such as T junctions and bends, and points in front of other supply-air devices.

#### Protective distance

- before bends 1 x D
- after " 1 x D
- before T-pipes 3 x D
- after " 1 x D
- before supply-air devices 3 x D

### Accessories

### Dimensions

	$\varnothing d$	C	$\varnothing D$
SPM 160	159	60	230
SPM 200	199	62	285
SPM 250	249	62	333
SPM 300	299	63	406
SPM 315	314	63	406
SPM 400	399	70	560

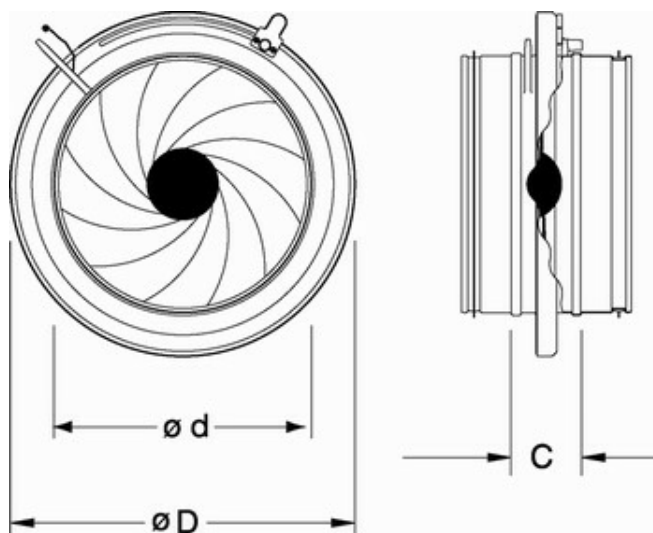

### Documentation

#### Get In Touch

Call: [0845 6880112](tel:08456880112)  
 Email: [info@adremit.co.uk](mailto:info@adremit.co.uk)

#### Our Address

Puravent, Adremit Limited, Unit 5a, Commercial Yard,  
 Settle, North Yorkshire, BD24 9RH

## Diagram

Mid-frequency band, Hz

	63	125	250	500	1K	2K	4K
SPM 160	9	6	1	-5	-11	-18	-27
SPM 200	9	5	1	-5	-12	-17	-24
SPM 250	6	1	-4	-3	-12	-17	-24
SPM 315	3	1	-4	-4	-9	-14	-23
SPM 400	3	1	-4	-4	-9	-13	-19
Tolerance	±6	±5	±2	±2	±2	±2	±3

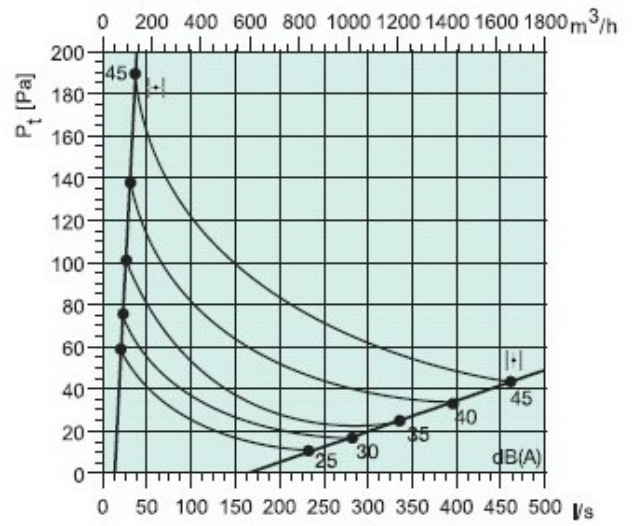

Name: **SPM-315 IRIS DAMPER WITH BULB** | Item no.: **6255**

2 / 2

Document type: **Product card** | Document date: **2019-06-20** | Generated by: **Online catalogue**

### Get In Touch



Call: [0845 6880112](tel:08456880112)



Email: [info@adremit.co.uk](mailto:info@adremit.co.uk)

### Our Address

Puravent, Adremit Limited, Unit 5a, Commercial Yard,  
Settle, North Yorkshire, BD24 9RH