



# RS 70-40 L3 SILEO

Item no. 39632

Version: 50 Hz; 400V 3~



## Description

- Speed-controllable
- Integral thermal contacts
- Can be installed in any position
- Maintenance-free and reliable

The RS models have impellers with backward-curved blades and external rotor motors. The motor and impeller are mounted on the access cover to facilitate easy maintenance. To protect the motor from overheating the RS has integral thermal contacts with external leads for connection to a motor protection device. The fan can be installed in any position and is easy to connect using the DS flexible connections. The casing is manufactured from galvanised sheet steel.



## Technical parameters

Nominal data		
Voltage	400	V
Frequency	50	Hz
Phase	3	~
Input power (P1)	542	W
Current	1,32	A
Max. airflow	1,28	m³/s
R.p.m.	1413	r.p.m.
Weight	34,2	kg
Temperature data		
Max. temperature of transported air	70	°C
Max. temperature of transported air when speed-controlled	70	°C
Sound data		
Sound pressure level at 3 m	57,5	dB(A)

### Get In Touch

 Call: [0845 6880112](tel:08456880112)  
 Email: [info@adremit.co.uk](mailto:info@adremit.co.uk)

### Our Address

Puravent, Adremit Limited, Unit 5a, Commercial Yard,  
 Settle, North Yorkshire, BD24 9RH



### Protection / Classification

Insulation class	F
Enclosure class, motor	IP54

### ErP

ErP ready	ErP 2018
-----------	----------

## Diagrams

### Diagrams

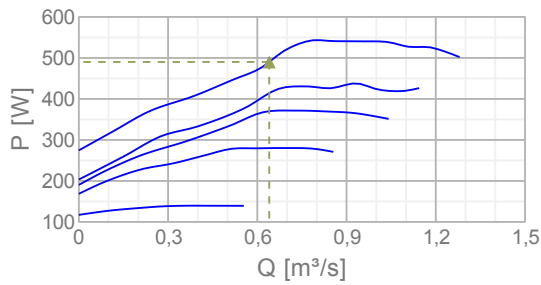
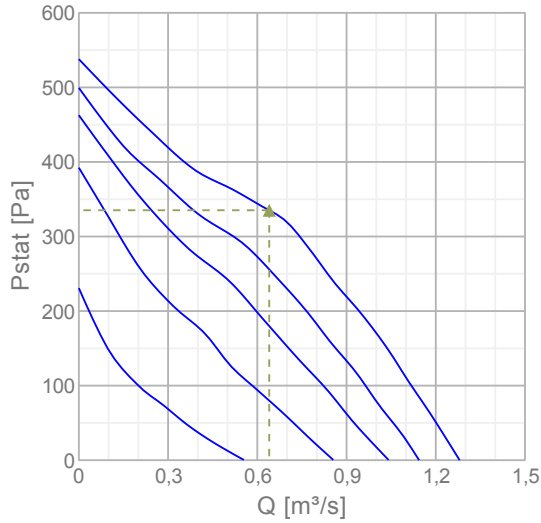

### Max efficiency

Hydraulic data										
▲ Working air flow	0,64 m³/s									
▲ Working static pressure	335 Pa									
▲ Power	490 W									
Speed	1423 r.p.m.									
Current	1,26 A									
SFP	0,766 W/(l/s)									
Voltage	400 V									
Sound power level	63	125	250	500	1k	2k	4k	8k	Tot	
Inlet										
Outlet										
Surrounding										

Name: **RS 70-40 L3 SILEO** | Item no.: **39632** | Version: **50 Hz; 400V 3~**

2 / 5

Document type: **Product card** | Document date: **2019-06-25** | Generated by: **Online catalogue**

### Get In Touch

Call: [0845 6880112](tel:08456880112)  
 Email: [info@adremit.co.uk](mailto:info@adremit.co.uk)

### Our Address

Puravent, Adremit Limited, Unit 5a, Commercial Yard,  
 Settle, North Yorkshire, BD24 9RH

## Dimensions

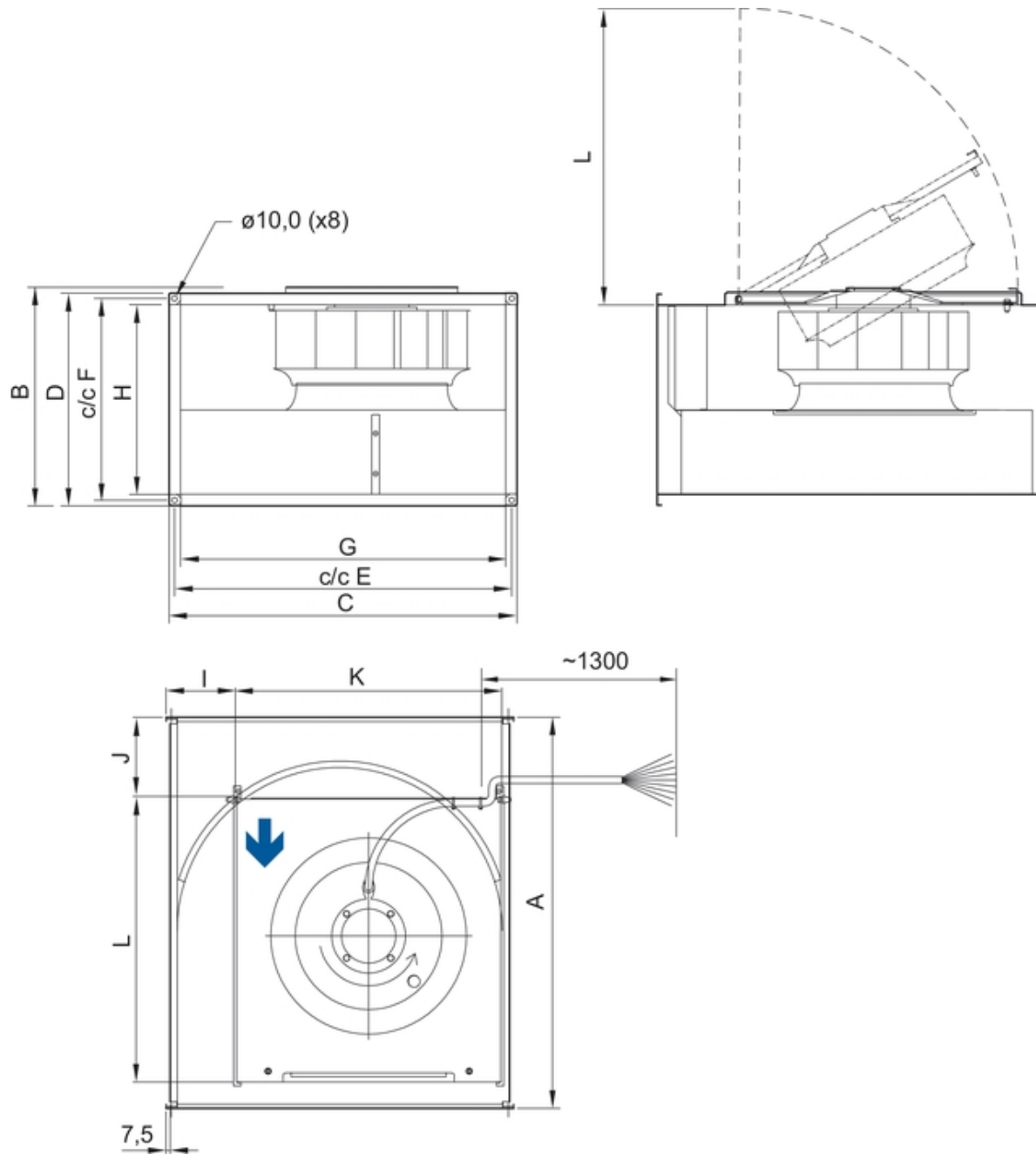



RS	A	B	C	D	E	F	G	H	I	J	K	L
70-40 L	787	452	740	440	720	420	698	398	189,5	215	490	524

Name: **RS 70-40 L3 SILEO** | Item no.: **39632** | Version: **50 Hz; 400V 3~**

Document type: **Product card** | Document date: **2019-06-25** | Generated by: **Online catalogue**

3 / 5

### Get In Touch

 Call: [0845 6880112](tel:08456880112)  
 Email: [info@adremit.co.uk](mailto:info@adremit.co.uk)

### Our Address

Puravent, Adremit Limited, Unit 5a, Commercial Yard,  
Settle, North Yorkshire, BD24 9RH

400V 3~

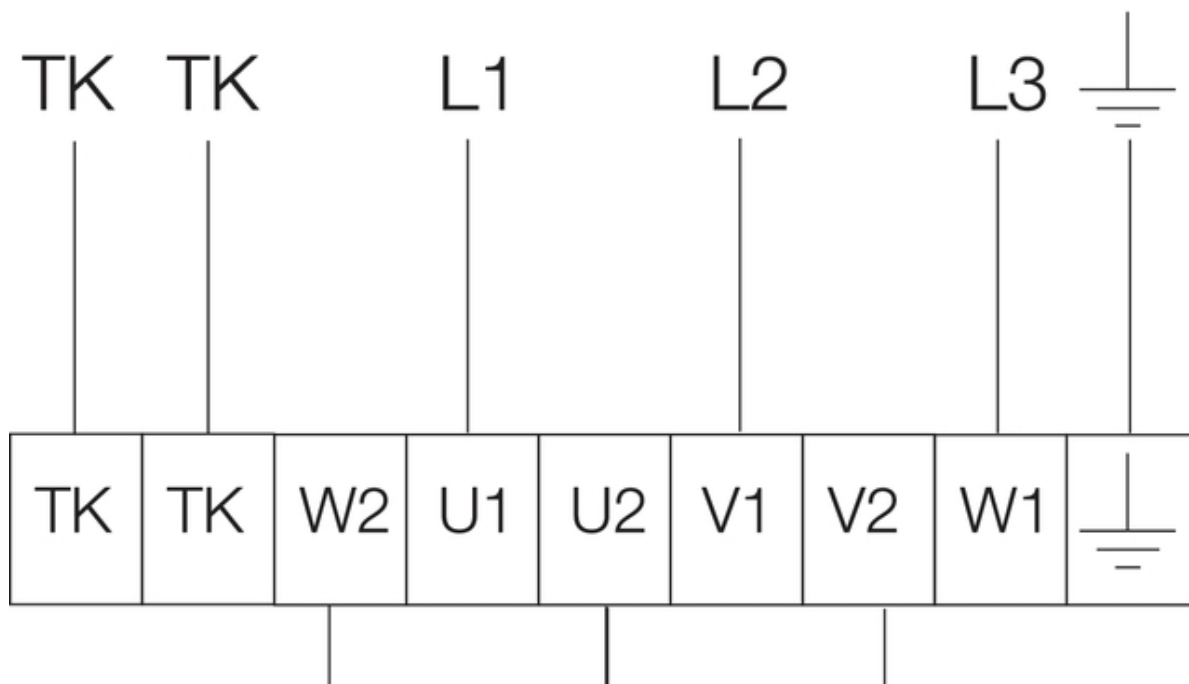

### Accessories

#### Electric accessories

[RTRD 2 Speed Cont. Systemair \(5941\)](#)  
[RTRDU 2 Speed contr. Systemair \(5945\)](#)  
[RT 0-30 Room Thermostat \(5151\)](#)  
[STDT 16 Motor Protection \(5152\)](#)  
[STDT 16E Motor Protection \(5153\)](#)  
[CO2RT-R-D Transmitter \(6993\)](#)  
[Presence detector/IR24-P \(6995\)](#)  
[DTV200 \(6261\)](#)  
[REV-5POL/07 ON/OFF \(33980\)](#)  
[DTV500A \(96807\)](#)

#### Accessories

[RBM 70-40/27 400V/3 Duct heater \(5455\)](#)  
[PGK 70-40-3-2,0 Duct cooler \(6616\)](#)  
[VBR 70-40-2 Water heating batt \(5468\)](#)  
[VBR 70-40-3 Water heating batt \(5476\)](#)  
[LDR 70-40 Silencer \(5074\)](#)  
[FFK 70-40 Filter cassette rect \(1762\)](#)  
[DS 70-40 Flexible connection \(1551\)](#)  
[GFL 70-40 Counter flange \(2710\)](#)  
[VK-70-40 Louvre shutter \(5652\)](#)  
[DXRE 70-40-3-2,5 Duct cooler \(7957\)](#)  
[RB 70-40/27-2 400V/3 Duct heat \(9645\)](#)  
[RB 70-40/45-3 400V/3 Duct heat \(9646\)](#)  
[RKT-SYS-700x400-S \(43636\)](#)  
[RK-SYS-700x400-R \(43648\)](#)  
[RK-SYS-700x400-S \(43657\)](#)

### Documentation

[202341\\_Fans\\_Instructions\\_CE\\_A010.pdf \(1,83MB\)](#)

### Get In Touch

 **Call:** [0845 6880112](tel:08456880112)  
 **Email:** [info@adremit.co.uk](mailto:info@adremit.co.uk)

### Our Address

Puravent, Adremit Limited, Unit 5a, Commercial Yard,  
 Settle, North Yorkshire, BD24 9RH



## Specification text

Circular duct fan for easy and direct installation in ducts.  
Galvanized sheet steel housing.  
Service cover. The fan unit is mounted on the service cover for easy cleaning and maintenance.

Free-running, backward curved circular impeller made of coated steel sheet.  
Impeller acc. to VDI 2060, balancing quality G 6.3, dynamically balanced in two planes.

Voltage controllable external rotor motor (IP44), maintenance-free, the motor is placed inside the air flow for cooling. Integral thermal contacts acc. to EN 60335-2-80 with leads to a motor protection device. Speed-controlled by voltage reduction via transformer.  
Controllable via frequency inverter and all-pole sinusoidal filter.  
Terminal box on the casing.

For extract and supply air.  
Installation in any mounting position.

For indoor installation.

### Get In Touch

 Call: [0845 6880112](tel:08456880112)  
 Email: [info@adremit.co.uk](mailto:info@adremit.co.uk)

### Our Address

Puravent, Adremit Limited, Unit 5a, Commercial Yard,  
Settle, North Yorkshire, BD24 9RH