



# RS 30-15 EC SILEO

Item no. 77061



## Description

- EC-motors, high level of efficiency
- 100% speed controllable
- Integrated motor protection
- Can be installed in any position
- Potentiometer included for easy commissioning

The RSI models are thermally and acoustically insulated with 50mm mineral wool and perforated sheet steel on the inner surface. This gives a quiet running with many installation possibilities.

The RS/RSI EC series have impellers with backward-curved blades and are fitted to EC external rotor motors. These fans have a high capacity in relation to their compact design. The fans are delivered with a pre-wired potentiometer (0-10V) which allows you to easily find the desired working point.

EC fans are notable for their economical use of energy and excellent ease of control. They can be varied in speed to match the airflow demand, and operate at high efficiency levels. For the same air volume, they consume distinctly less energy than AC fan drives.

Motor protection is integrated in the electronics of the motor. The casing is manufactured from galvanized sheet steel.

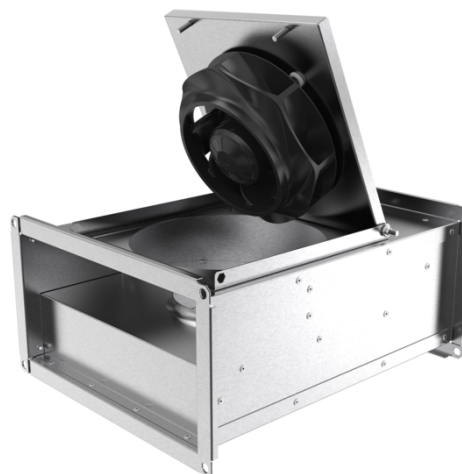

## Technical parameters

Nominal data	
Voltage	230 V
Frequency	50 Hz
Phase	1 ~
Input power (P1)	89,2 W
Current	0,733 A
Max. airflow	0,179 m³/s
R.p.m.	3216 r.p.m.
Weight	6,2 kg
Temperature data	
Max. temperature of transported air	60 °C
Max. temperature of transported air when speed-controlled	60 °C
Sound data	
Sound pressure level at 3 m	49,5 dB(A)
Protection / Classification	
Insulation class	B
Enclosure class, motor	IP54

### Get In Touch

Call: [0845 6880112](tel:08456880112)  
 Email: [info@adremit.co.uk](mailto:info@adremit.co.uk)

### Our Address

Puravent, Adremit Limited, Unit 5a, Commercial Yard,  
 Settle, North Yorkshire, BD24 9RH



## Diagrams

### Diagrams

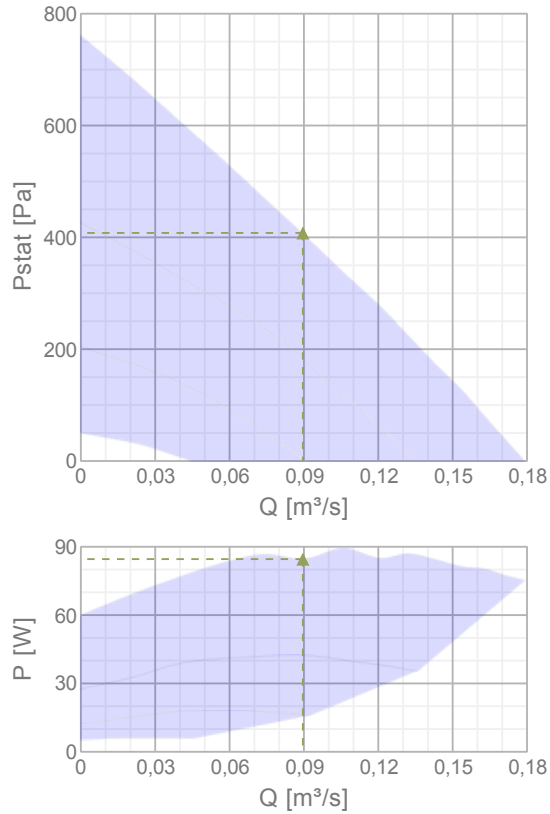

### Max efficiency

Hydraulic data										
▲ Working air flow										0,0896 m <sup>3</sup> /s
▲ Working static pressure										408 Pa
▲ Power										84,6 W
Speed										3216 r.p.m.
Current										0,707 A
SFP										0,944 W/(l/s)
Voltage										230 V
Sound power level		63	125	250	500	1k	2k	4k	8k	Tot
Inlet	dB(A)	66	57	63	68	61	63	58	56	72
Outlet	dB(A)	59	56	63	70	66	68	63	62	74
Surrounding	dB(A)	44	41	44	55	46	46	41	37	57

### Get In Touch

Call: [0845 6880112](tel:08456880112)Email: [info@adremit.co.uk](mailto:info@adremit.co.uk)

### Our Address

Puravent, Adremit Limited, Unit 5a, Commercial Yard,  
Settle, North Yorkshire, BD24 9RH

**Dimensions**

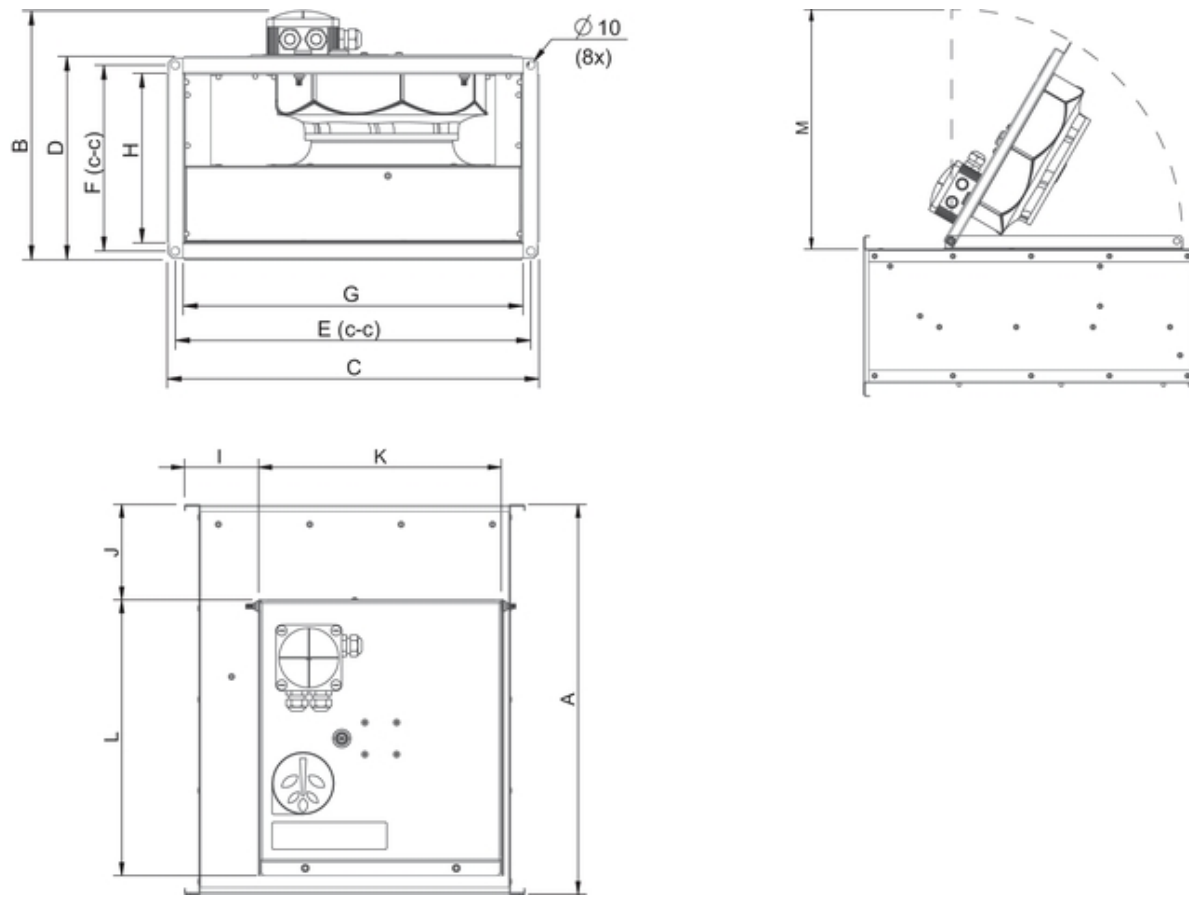



	A	B	C	D	E	F	G	H	I	J	K	L	M
RS 30-15 EC	402	227	340	190	320	170	298	149	79	120	230	254	257

Name: **RS 30-15 EC SILEO** | Item no.: **77061**

Document type: **Product card** | Document date: **2019-06-25** | Generated by: **Online catalogue**

**Get In Touch**

 **Call:** [0845 6880112](tel:08456880112)  
 **Email:** [info@adremit.co.uk](mailto:info@adremit.co.uk)

**Our Address**

Puravent, Adremit Limited, Unit 5a, Commercial Yard,  
Settle, North Yorkshire, BD24 9RH



## Wiring

# 230V 1~

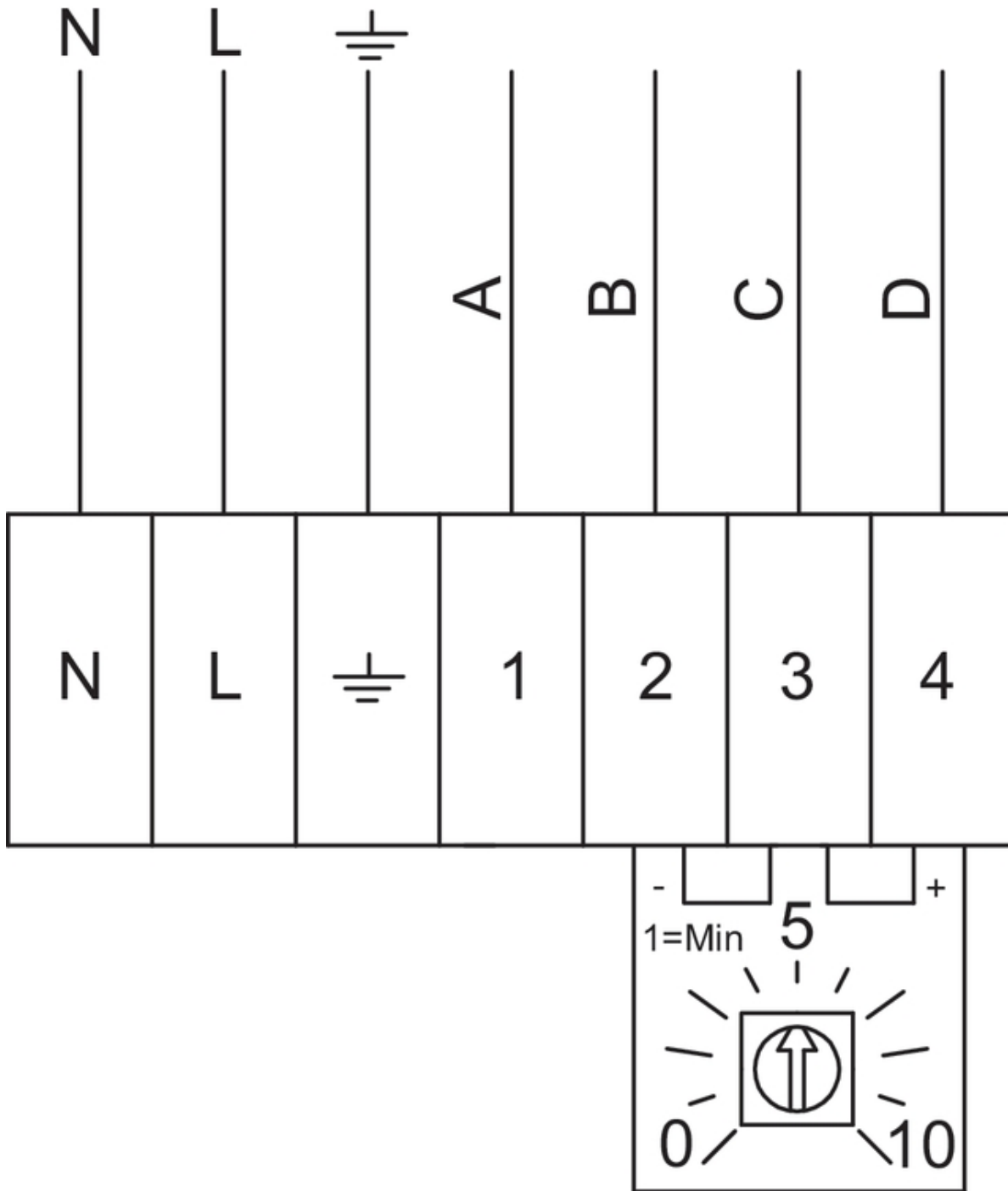

Terminal	Cable	Description
1	White	Tacho output, Isink max 10mA
2	Blue	GND
3	Yellow	Control input 0-10 VDC/PWM
4	Red	Output 10 VDC max 1.1 mA



Internal potentiometer, default

Name: **RS 30-15 EC SILEO** | Item no.: **77061**

Document type: **Product card** | Document date: **2019-06-25** | Generated by: **Online catalogue**

4 / 5

### Get In Touch

 Call: [0845 6880112](tel:08456880112)  
 Email: [info@adremit.co.uk](mailto:info@adremit.co.uk)

### Our Address

Puravent, Adremit Limited, Unit 5a, Commercial Yard,  
Settle, North Yorkshire, BD24 9RH

## Accessories

### Electric accessories

[RT 0-30 Room Thermostat \(5151\)](#)  
[CO2RT-R-D Transmitter \(6993\)](#)  
[Presence detector/IR24-P \(6995\)](#)  
[MTV-1/010 Controller 0..10V+ \(30650\)](#)  
[MTP 10, 10K, Speed control \(32731\)](#)  
[DTV200 \(6261\)](#)  
[EC-Vent Room Unit \(3018\)](#)  
[EC-Vent control board \(3115\)](#)  
[REV-3POL/03 ON/OFF \(33978\)](#)  
[MTP 20, on/off, 3-step \(310220\)](#)  
[EC-Basic-H humidity \(24807\)](#)  
[EC-Basic-T temperature \(24805\)](#)  
[EC-Basic-U universal 0-10V \(24806\)](#)  
[EC-Basic-CO2 and temperature \(24808\)](#)  
[S-5EC/FRQ \(76738\)](#)  
[DTV500A \(96807\)](#)

### Accessories

[LDR 30-15 Silencer \(5068\)](#)  
[FFK 30-15 Filter cassette rect \(1748\)](#)  
[DS 30-15 Flexible connection \(1537\)](#)  
[RKT-SYS-300x150-S \(43628\)](#)  
[RK-SYS-300x150-R \(43642\)](#)

## Documentation

 [202341\\_Fans\\_Instructions\\_CE\\_A010.pdf \(1,83MB\)](#)

 [EC-fans\\_Operation\\_and\\_maintenance\\_instr\\_206268\\_CE\\_\(A022\).pdf \(2,88MB\)](#)

 [Certificate S-mark RS 1211225.pdf \(789,65kB\)](#)

## Specification text

Rectangular duct fan for easy and direct installation in ducts. For extract and supply air installations. Galvanized sheet steel housing. Service cover. The fan unit is mounted on the service cover for easy cleaning and maintenance. Free-running, backward curved circular impeller made of composite PA6. Impeller acc. to VDI 2060, balancing quality G 6.3, dynamically balanced in two planes. EC-external rotor motor, maintenance-free, the motor is placed inside the air flow for cooling. Integrated, electronic motor protection. Integrated speed controller, the fan is equipped with a potentiometer (0-10V) to set the operating point directly. Integrated, electronic motor protection. Installation in any mounting position. For indoor installation.

### Get In Touch



Call: [0845 6880112](tel:08456880112)



Email: [info@adremit.co.uk](mailto:info@adremit.co.uk)

### Our Address

Puravent, Adremit Limited, Unit 5a, Commercial Yard,  
Settle, North Yorkshire, BD24 9RH