



RSK-560 BACK DRAFT DMP.

Item no. 9769

Document type: **Product card**

Document date: **2019-06-24**

Generated by: **Systemair Online Catalogue**

Description

Back draft damper for circular ducts, manufactured from galvanised sheet steel. The two blades are spring-loaded, which means that the damper can also be mounted vertically.



Dimensions

	ØA	D	B	C
RSK 450	450	247	75	75
RSK 500	500	247	75	75
RSK 560	560	247	75	75
RSK 630	630	247	75	75

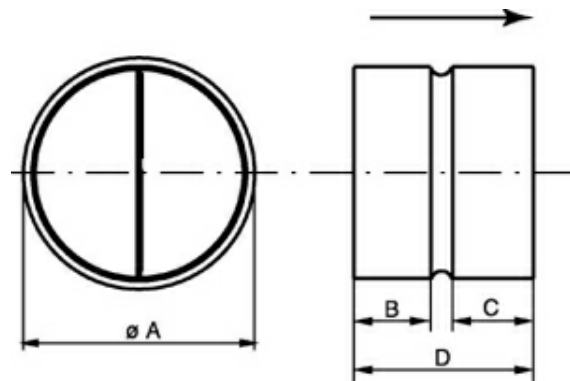

Documentation

 [EC Declaration of conformity RSK EN-DE.pdf \(72,01kB\)](#)

Get In Touch



Call: [0845 6880112](tel:08456880112)



Email: info@adremit.co.uk

Our Address

Puravent, Adremit Limited, Unit 5a, Commercial Yard,
Settle, North Yorkshire, BD24 9RH

Diagram

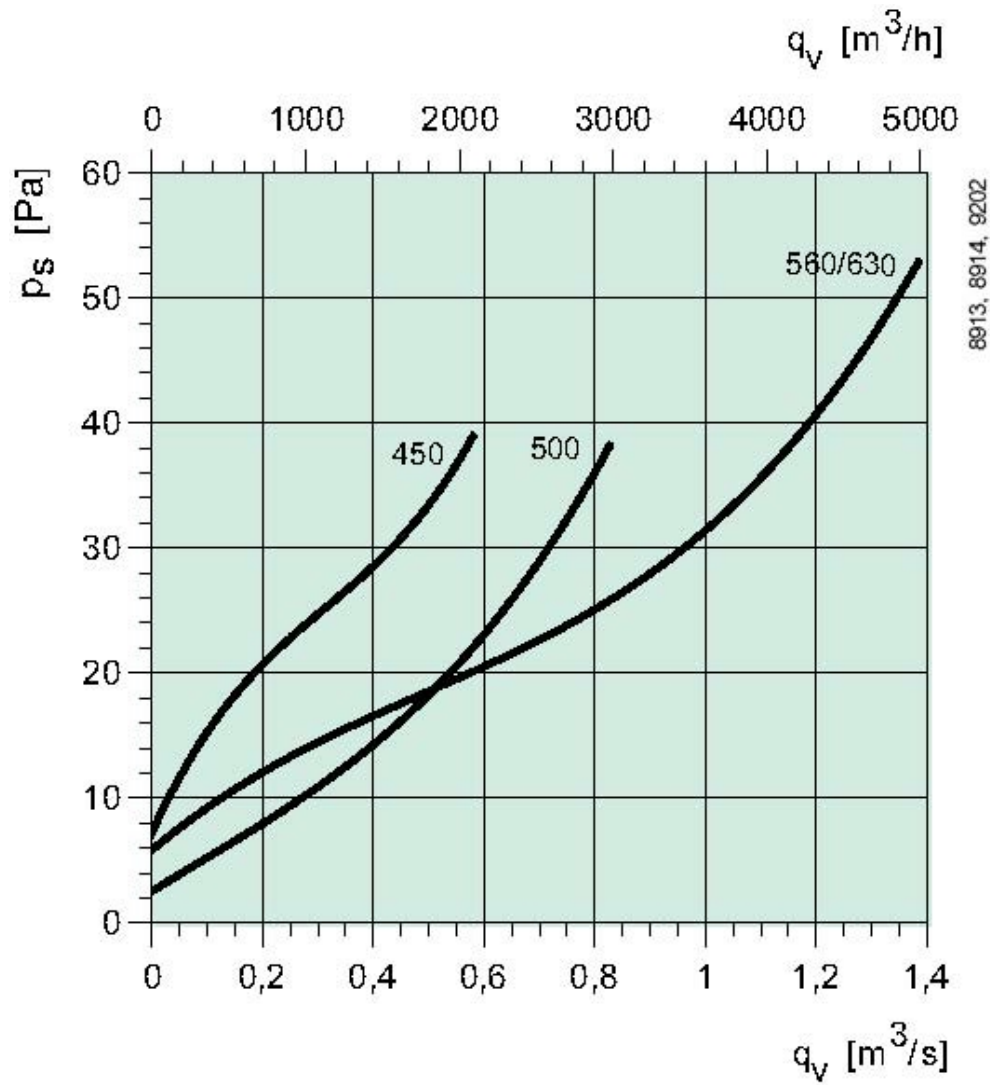

Specification text

Name: RSK-560 BACK DRAFT DMP. | Item no.: 9769

Document type: Product card | Document date: 2019-06-24 | Generated by: Online catalogue

Get In Touch

Call: 0845 6880112
Email: info@adremit.co.uk

Our Address

Puravent, Adremit Limited, Unit 5a, Commercial Yard,
Settle, North Yorkshire, BD24 9RH