



RSI 80-50 L3 SILEO

Item no. 39640

Version: 50 Hz; 400V 3~



Description

- Speed-controllable
- Integral thermal contacts
- Can be installed in any position
- Maintenance-free and reliable

The RSI models have impellers with backward-curved blades and external rotor motors. The motor and impeller are mounted on the access cover to facilitate easy maintenance. The RSI models are thermally and acoustically insulated with 50 mm of mineral wool, with perforated sheet steel on the inner surface. To protect the motor from overheating the RSI fans have integral thermal contacts with external leads for connection to a motor protection device. The fans can be installed in any position and are easy to connect using the DS flexible connections. The casing is manufactured from galvanised sheet steel.

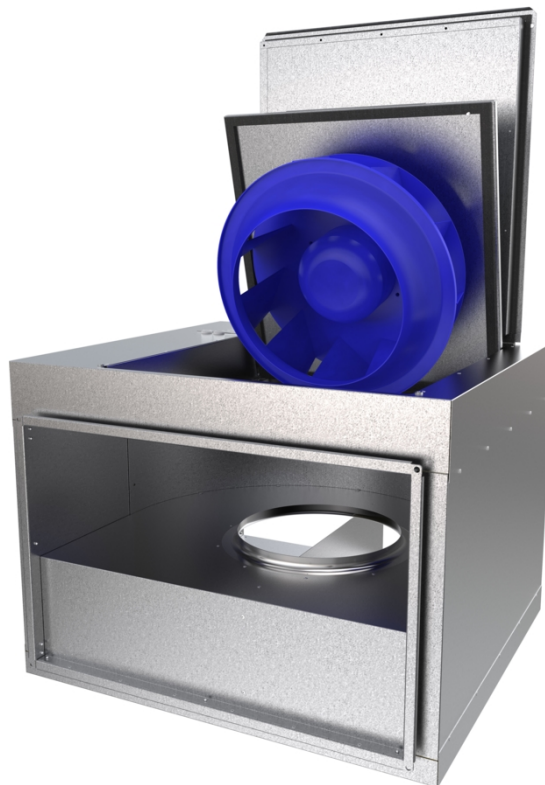

Technical parameters

Nominal data		
Voltage	400	V
Frequency	50	Hz
Phase	3	~
Input power (P1)	1379	W
Current	3,16	A
Max. airflow	2,35	m³/s
R.p.m.	1420	r.p.m.
Weight	114	kg
Temperature data		
Max. temperature of transported air	70	°C
Max. temperature of transported air when speed-controlled	70	°C

Get In Touch

Call: [0845 6880112](tel:08456880112)
 Email: info@adremit.co.uk

Our Address

Puravent, Adremit Limited, Unit 5a, Commercial Yard,
 Settle, North Yorkshire, BD24 9RH



Sound data

Sound pressure level at 3 m 60 dB(A)

Protection / Classification

Insulation class F

Enclosure class, motor IP54

ErP

ErP ready ErP 2018

Diagrams

Diagrams

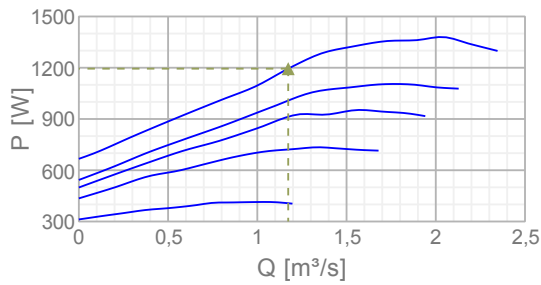
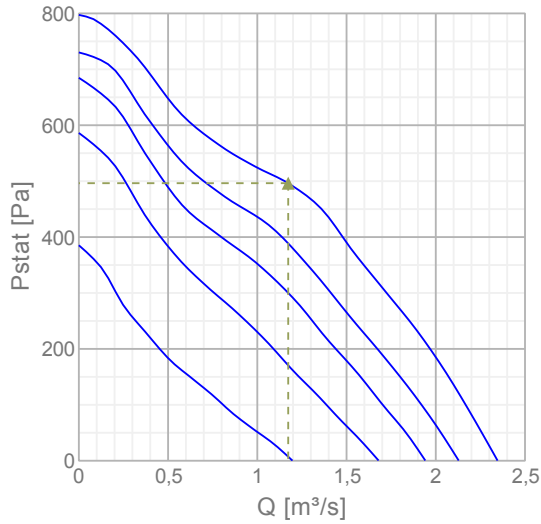

Max efficiency

Hydraulic data

▲ Working air flow	1,17 m³/s
▲ Working static pressure	496 Pa
▲ Power	1195 W
Speed	1431 r.p.m.
Current	2,98 A
SFP	1,02 W/(l/s)
Voltage	400 V

Sound power level		63	125	250	500	1k	2k	4k	8k	Tot
Inlet	dB(A)	63	72	69	70	68	66	62	56	77
Outlet	dB(A)	69	78	79	80	82	78	73	64	87
Surrounding	dB(A)	52	63	59	60	58	55	51	44	67

Name: **RSI 80-50 L3 SILEO** | Item no.: **39640** | Version: **50 Hz; 400V 3~**

2 / 5

Document type: **Product card** | Document date: **2019-06-24** | Generated by: **Online catalogue**

Get In Touch

Call: 0845 6880112
Email: info@adremit.co.uk

Our Address

Puravent, Adremit Limited, Unit 5a, Commercial Yard,
Settle, North Yorkshire, BD24 9RH

Dimensions

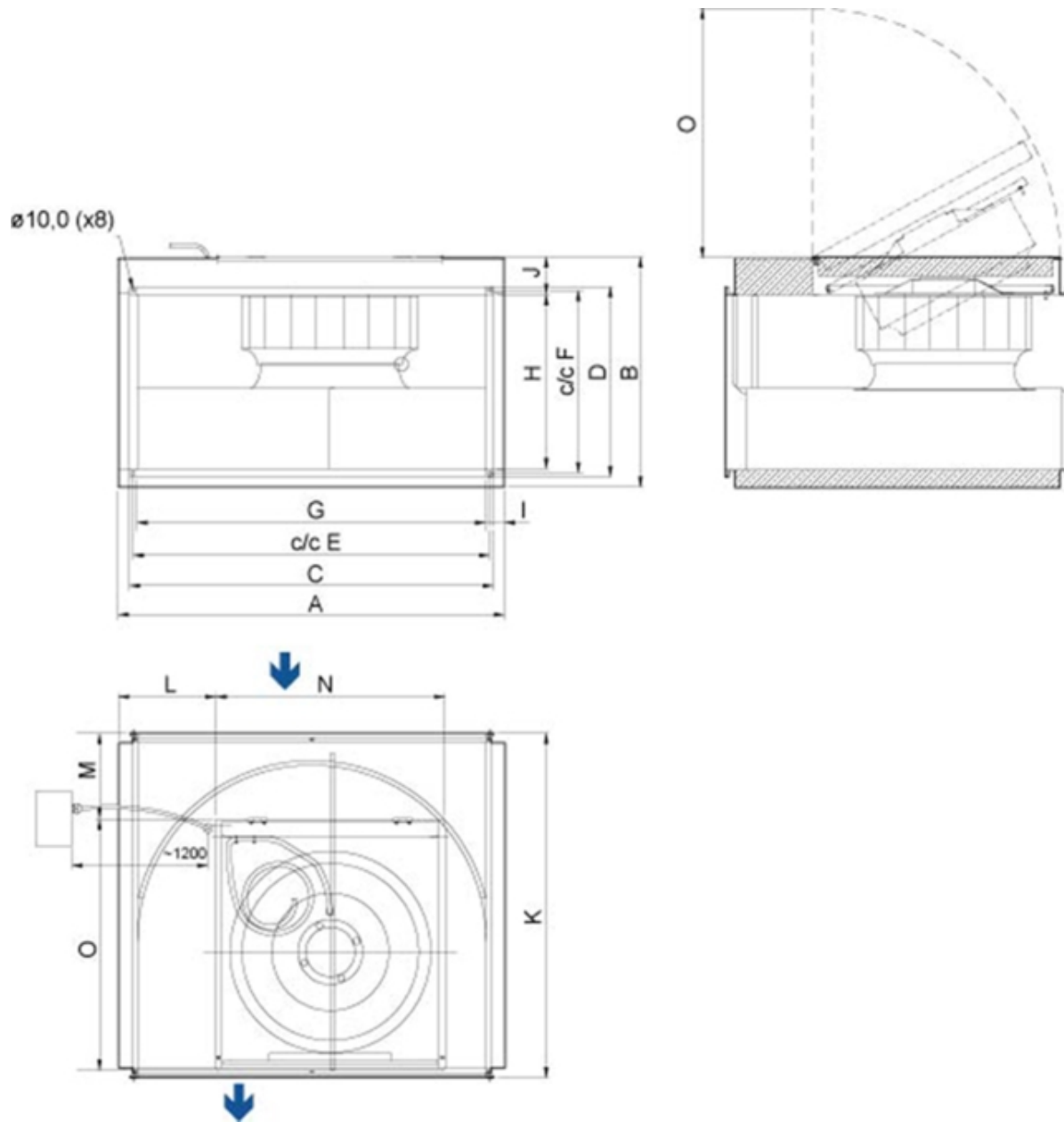



RSI	A	B	C	D	E	F	G	H	I	J	K	L	M	N	O
80-50L	908	662	841	541	820	520	797	497	55,5	112,5	882	194	144,5	656	717

Name: **RSI 80-50 L3 SILEO** | Item no.: **39640** | Version: **50 Hz; 400V 3~**

Document type: **Product card** | Document date: **2019-06-24** | Generated by: **Online catalogue**

3 / 5

Get In Touch

 Call: [0845 6880112](tel:08456880112)
 Email: info@adremit.co.uk

Our Address

Puravent, Adremit Limited, Unit 5a, Commercial Yard,
Settle, North Yorkshire, BD24 9RH

400V 3~

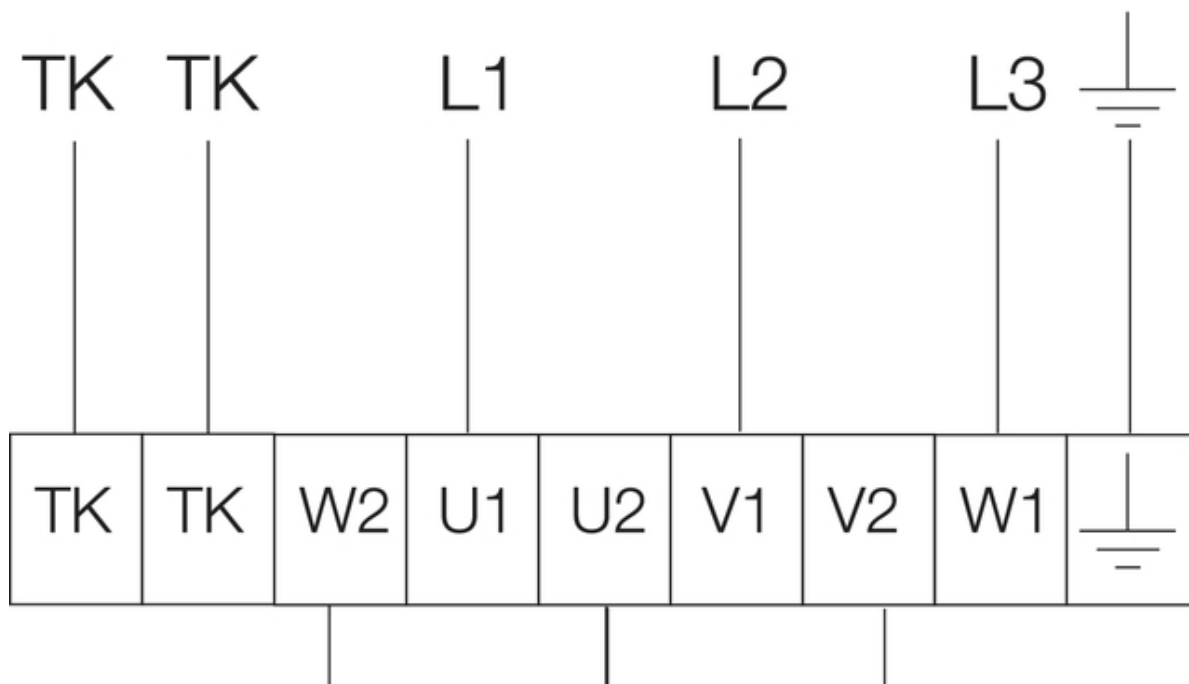

Accessories

Electric accessories

[RTRD 7 speed control Systemair \(5943\)](#)
[RTRDU 7 Speed contr. Systemair \(5947\)](#)
[RT 0-30 Room Thermostat \(5151\)](#)
[STDT 16 Motor Protection \(5152\)](#)
[STDT 16E Motor Protection \(5153\)](#)
[CO2RT-R-D Transmitter \(6993\)](#)
[Presence detector/IR24-P \(6995\)](#)
[DTV200 \(6261\)](#)
[REV-5POL/07 ON/OFF \(33980\)](#)
[DTV500A \(96807\)](#)

Accessories

[VBR 80-50-2 Water heating batt \(5469\)](#)
[VBR 80-50-3 Water heating batt \(5477\)](#)
[LDR 80-50 Silencer \(5075\)](#)
[FFK 80-50 filter cassette \(30236\)](#)
[DS 80-50 Flexible connection \(1553\)](#)
[GFL 80-50 Counter flange \(2711\)](#)
[VK-80-50 Louvre shutter \(5655\)](#)
[DXRE 80-50-3-2,5 Duct cooler \(7958\)](#)
[RB 80-50/45-3 400V/3 Duct heat \(9647\)](#)
[RB 80-50/68-4 400V/3 Duct heat \(9648\)](#)
[RKT-SYS-800x500-S \(43639\)](#)
[RK-SYS-800x500-R \(43649\)](#)
[RK-SYS-800x500-S \(43658\)](#)

Documentation

 [202341_Fans_Instructions_CE_A010.pdf \(1,83MB\)](#)

Get In Touch

 **Call:** [0845 6880112](tel:08456880112)
 **Email:** info@adremit.co.uk

Our Address

Puravent, Adremit Limited, Unit 5a, Commercial Yard,
Settle, North Yorkshire, BD24 9RH



Specification text

The box consists of electroplated steel plate. The fans have a radial impeller with backwards- curved impeller vanes witch are pivoting. For making cleaning and attendance easier the fan device is assembled at the folding closure head. The fans can be installed in each fitting position and with the help of the flexible DS connection they are very easy to built in. The actuation is carried out by a foolproofed, maintenance- free and speed- controlled external rotor motor. For protecting the motor, the production run has built in thermal contacts with manually reset device with completed lines to a motor protection device according to EN 60335-2-80. For annealing the engine is designed inside the air flow. Impeller according to VDI 2060, quality category Q6,3 and dynamically weigh heavy in two levels.

Get In Touch



Call: [0845 6880112](tel:08456880112)



Email: info@adremit.co.uk

Our Address

Puravent, Adremit Limited, Unit 5a, Commercial Yard,
Settle, North Yorkshire, BD24 9RH