



RE 5 SPEED CONTROL

Item no. 5002

Document type: **Product card**
 Document date: **2019-06-25**
 Generated by: **Systemair Online Catalogue**

Description

Manual five-step transformer

A single-phase transformer which controls the fan speed by altering the supply voltage in five fixed steps. The steps are adjusted manually, using the control knob on the front of the unit. The transformer has 230V terminals for operating dampers, electric heater batteries or other external equipment. When the transformer knob is in position 0, the outlet has no current. The indicator lamp on the front shows that the transformer is in operation. The fuse may be reset from outside. The RE has a selfextinguishing thermoplastic casing.

NOTE! Fans with external contact leads (TK) must always be connected to a motor protection device.



Technical parameters

Default group	
Voltage	230 V
Phase	1 ~
Frequency	50/60 Hz
Current	5 A
Enclosure class	IP54
Dimension	
Width	105 mm
Depth	105 mm
Height	200 mm
Weight	3,4 kg

Get In Touch

Call: [0845 6880112](tel:08456880112)
 Email: info@adremit.co.uk

Our Address

Puravent, Adremit Limited, Unit 5a, Commercial Yard,
 Settle, North Yorkshire, BD24 9RH

Dimensions

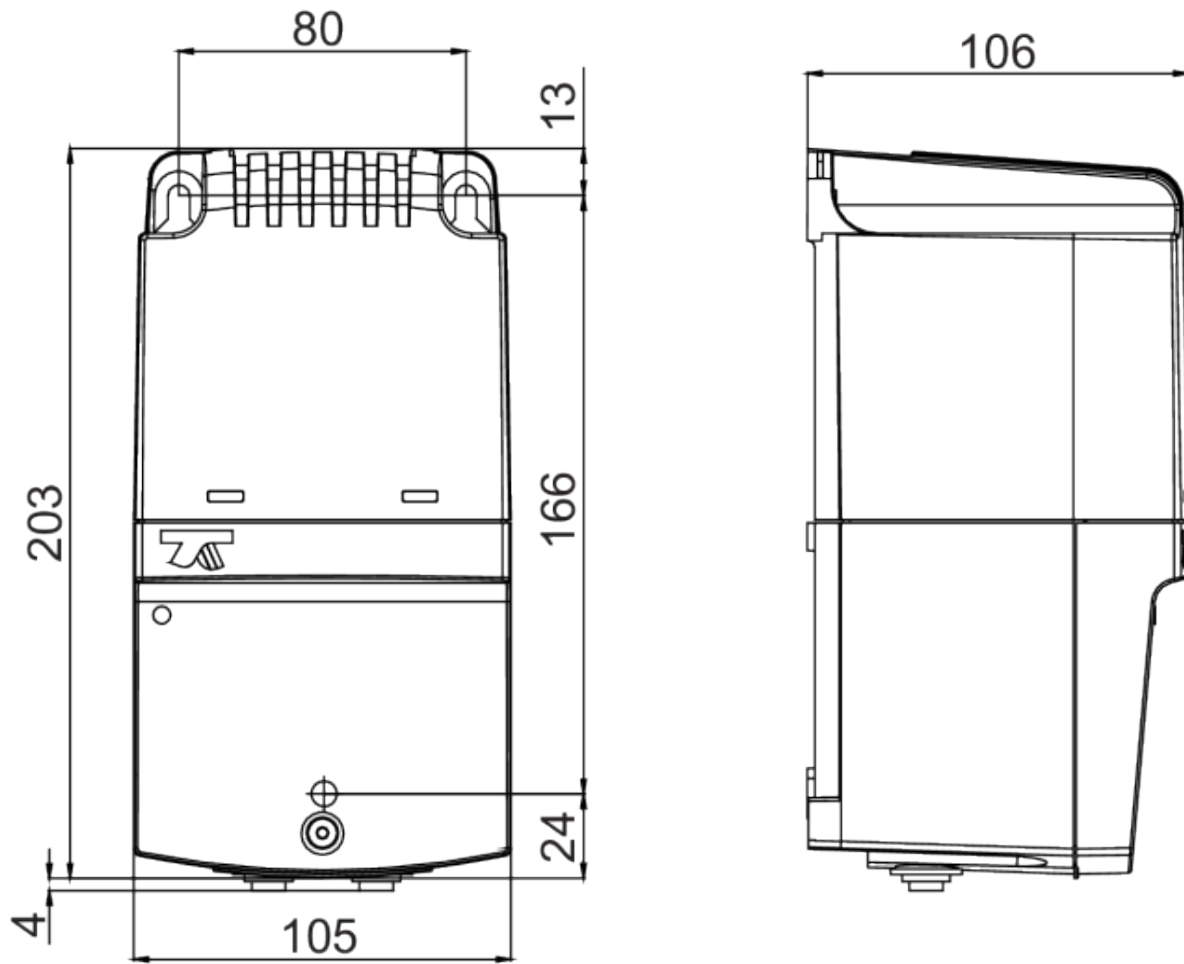

Documentation

 RE RTRE REU_ IMO_ GB.pdf (245,21kB)

 Declaration Of Conformity_RE_REU_RTRE_EN-2017.pdf (26,64kB)

Wiring

RE 1,5 RE 3 RE 5 RE 7

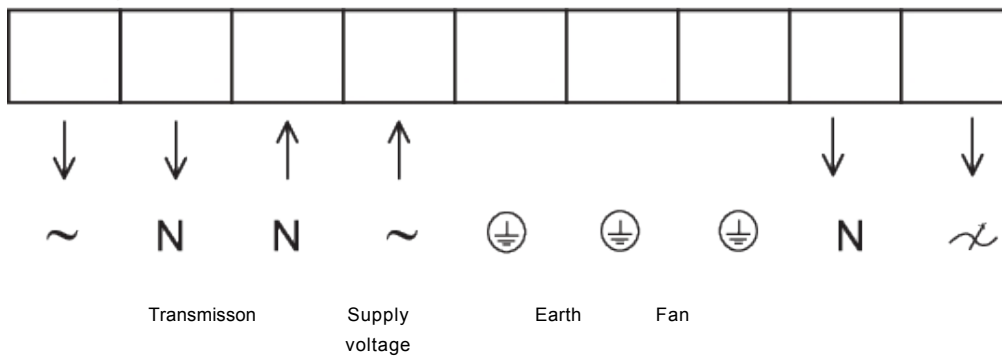

Transmission: between ~ and N is always 230V when the transformer handle is in pos. 1-5

Name: **RE 5 SPEED CONTROL** | Item no.: **5002**

Document type: **Product card** | Document date: **2019-06-25** | Generated by: **Online catalogue**

2 / 2

Get In Touch

 Call: [0845 6880112](tel:08456880112)
 Email: info@adremit.co.uk

Our Address

Puravent, Adremit Limited, Unit 5a, Commercial Yard,
 Settle, North Yorkshire, BD24 9RH