



# PULSER M TEMPERATURE CONTROL

Item no. 5144

Document type: **Product card**  
 Document date: **2019-07-02**  
 Generated by: **Systemair Online Catalogue**

## Description

Electronic temperature control

The Pulser M is a single or two-phase temperature regulator for controlling heater batteries. This device is connected in series between the mains and an electric heater. The Pulser M has an integral regulator with input terminals for a main sensor together with min. or max. limit sensors. The integral sensor can be used when regulating room temperature. The power regulation is completely stepless thanks to what is known as time-proportional control, which means that the relationship between the 'on' and 'off' times is determined by the set temperature requirement. The total 'on' and 'off' time, or pulse period, is approximately 1 minute.



## Technical parameters

Voltage	230/400	V
Phase	1/2	~
Frequency	50/60	Hz
Current	16	A
Heating power	max. 3600/6400	W
Temperature range of adjustment	0-30	°C
Temperature reduction at night	0-10	°C
Permitted range for ambient temperature	0-30	°C
Permitted range for ambient humidity	0-90	%RH
Enclosure class	20	
Weight	0,32	kg
Width	94	mm
Height	150	mm
Depth	43	mm

## Accessories

### Electric accessories

- [TG-K360 Duct sensor 0-60°C \(4846\)](#)
- [TG-K330 Duct Sensor 0-30°C \(5160\)](#)
- [TG-K350 Duct Sensor 20-50°C \(5161\)](#)
- [TG-R430 Room sensor 0-30°C \(5162\)](#)
- [TG-R530 Room sensor 0-30°C \(5163\)](#)
- [TG-R630 External sensor \(5164\)](#)
- [TG-R600 External sensor \(5174\)](#)

### Get In Touch

Call: [0845 6880112](tel:08456880112)  
 Email: [info@adremit.co.uk](mailto:info@adremit.co.uk)

### Our Address

Puravent, Adremit Limited, Unit 5a, Commercial Yard, Settle, North Yorkshire, BD24 9RH



## Wiring

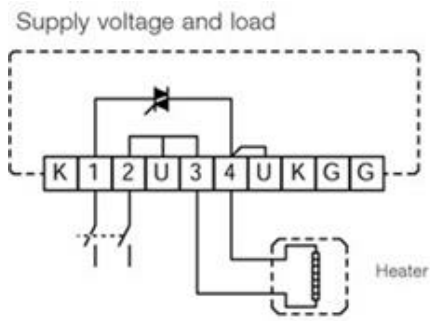

Position of change-over switch with internal sensor

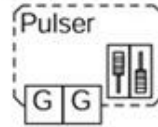

Position of change-over switch with external sensor

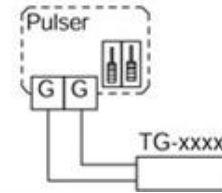

Adjustment of change-over switch with min. limit sensor

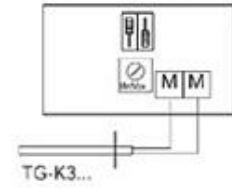

Adjustment of change-over switch with max. limit sensor

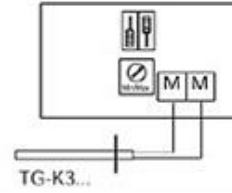

## Documentation

 [PULSER\\_M\\_IMO\\_GB\\_SE\\_DE\\_FR.pdf](#) (482,81kB)

 [PULSER-M\\_GB.pdf](#) (90,18kB)

 [EC\\_PULSER\\_RANGE.pdf](#) (48,58kB)

## Specification text

### Get In Touch



Call: [0845 6880112](tel:08456880112)



Email: [info@adremit.co.uk](mailto:info@adremit.co.uk)

### Our Address

Puravent, Adremit Limited, Unit 5a, Commercial Yard,  
Settle, North Yorkshire, BD24 9RH