



## PRF 250D2 IE3

Item no. 87991

Document type: **Product card**

Document date: **2019-07-02**

Generated by: **Systemair Online Catalogue**

### Description

- High efficient motor IE3
- Speed-controllable via frequency converter
- Integral cold conductor (PTC)
- Standard motor outside the air stream
- Temperature of transported air from -15°C - +70°C
- Position of casing can be easily adapted
- Single-flow impellers from PP with effective blade geometry
- Low sound level
- The powder painted pedestal is manufactured of galvanized steel
- Perfect fitting accessories: connections, dampers, splinter protection
- Easy to maintain and reliable

The PRF fans are equipped with high efficient IE3 motors. The PRF fans have been developed especially for the exhaust of aggressive media. This is the right fan when corrosive gases, contaminated air or other aggressive components are part of the exhaust air. Typical applications are medical facilities, the food-, electrical-or chemical industry. Speed control is only possible by using a frequency converter. Motor protection is done by cold conductors (PTC), which have to be connected to an external motor protection device.

The sintered casing is from UV-resistant PE and offers a variety of applications with its connectors from ø 125 - 250 mm. The casing can be easily adjusted through turning it (Standard position is LG270, see picture).



### Technical parameters

Nominal data		
Voltage	400	V
Frequency	50	Hz
Phase	3	~
Input power (P1)	3665	W
Current	5,66	A
Max. airflow	1,09	m³/s
R.p.m.	2936	r.p.m.
Weight	48	kg
Temperature data		
Max. temperature of transported air	70	°C
Sound data		
Sound pressure level at 3 m	85	dB(A)
Protection / Classification		
Insulation class	F	
Enclosure class, motor	IP55	

#### Get In Touch

Call: [0845 6880112](tel:08456880112)  
 Email: [info@adremit.co.uk](mailto:info@adremit.co.uk)

#### Our Address

Puravent, Adremit Limited, Unit 5a, Commercial Yard,  
 Settle, North Yorkshire, BD24 9RH

## Diagrams

### Diagrams

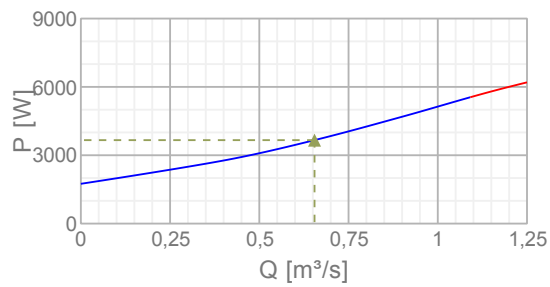
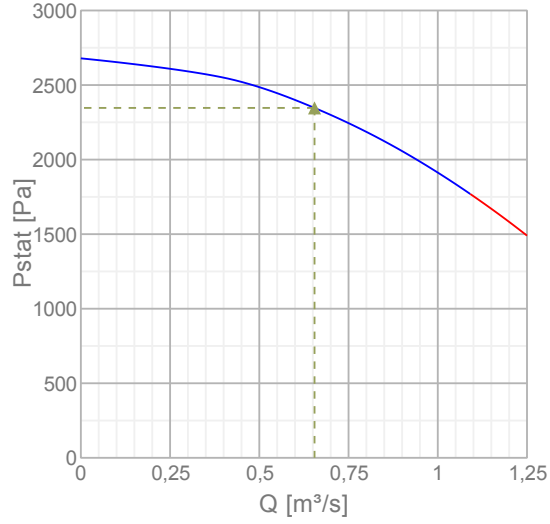

### Max efficiency

Hydraulic data										
▲ Working air flow										0,655 m³/s
▲ Working static pressure										2347 Pa
▲ Power										3663 W
Speed										2936 r.p.m.
Current										5,66 A
SFP										5,6 W/(l/s)
Voltage										400 V
Sound power level		63	125	250	500	1k	2k	4k	8k	Tot
Inlet	dB(A)	65	92	84	88	90	88	78	69	96
Outlet	dB(A)	66	93	85	89	91	90	80	70	97

Name: **PRF 250D2 IE3** | Item no.: **87991**

Document type: **Product card** | Document date: **2019-07-02** | Generated by: **Online catalogue**

2 / 5

### Get In Touch

Call: [0845 6880112](tel:08456880112)  
 Email: [info@adremit.co.uk](mailto:info@adremit.co.uk)

### Our Address

Puravent, Adremit Limited, Unit 5a, Commercial Yard,  
 Settle, North Yorkshire, BD24 9RH

## Dimensions

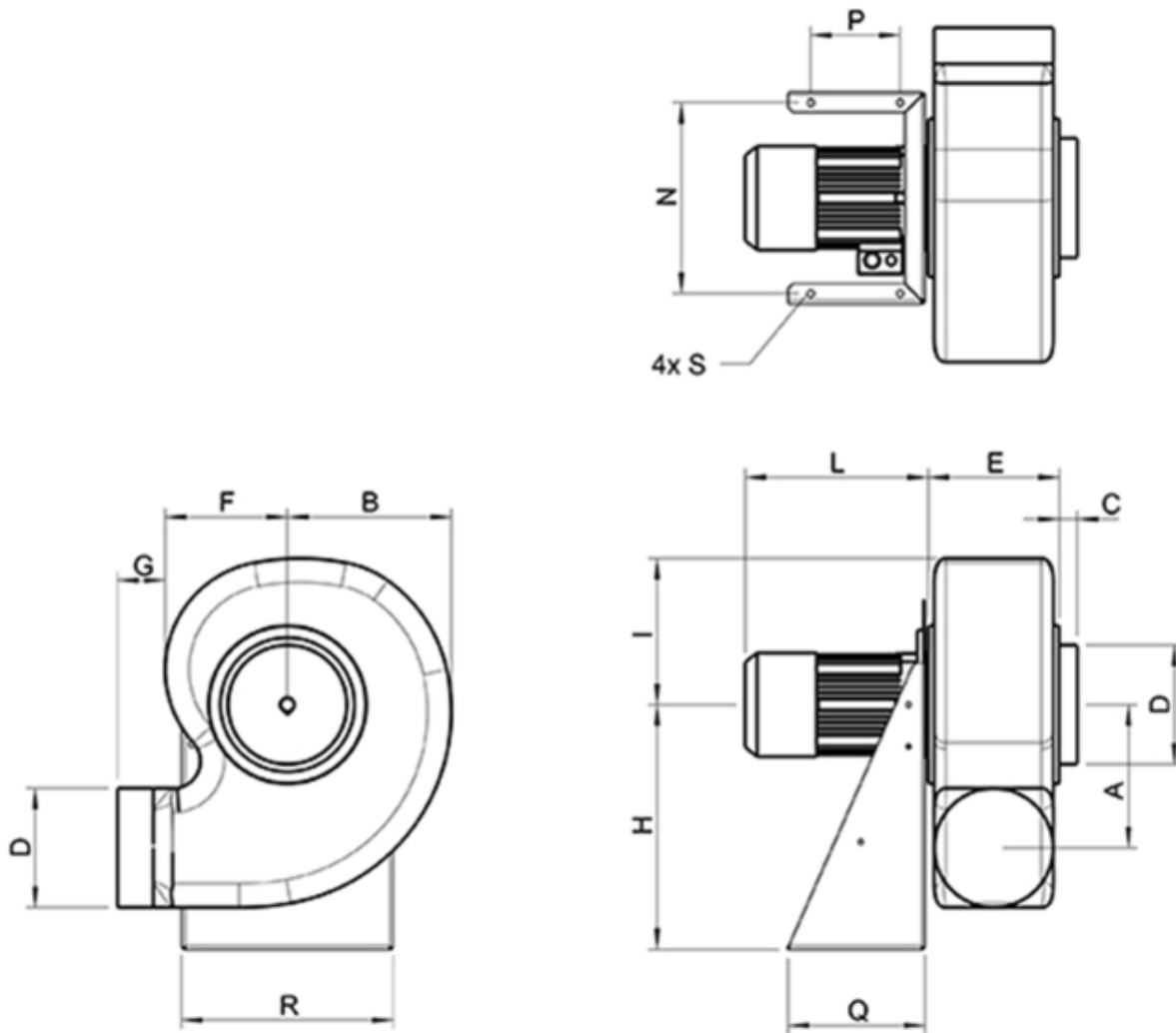

	A	B	C	øD	E	F	G	H	I	L	N	P	Q	R
PRF 250D2/D4	290	380	40	250	194	265	80	495	330	340	330	170	250	365
Total heigh= 825mm														

Name: **PRF 250D2 IE3** | Item no.: **87991**

3 / 5

Document type: **Product card** | Document date: **2019-07-02** | Generated by: **Online catalogue**

### Get In Touch



Call: [0845 6880112](tel:08456880112)



Email: [info@adremit.co.uk](mailto:info@adremit.co.uk)

### Our Address

Puravent, Adremit Limited, Unit 5a, Commercial Yard,  
Settle, North Yorkshire, BD24 9RH

**Dreiphasenmotor mit Kaltleiter**  
**Three phase motor with cold conductor**  
**Moteur triphasé avec résistance PTC**

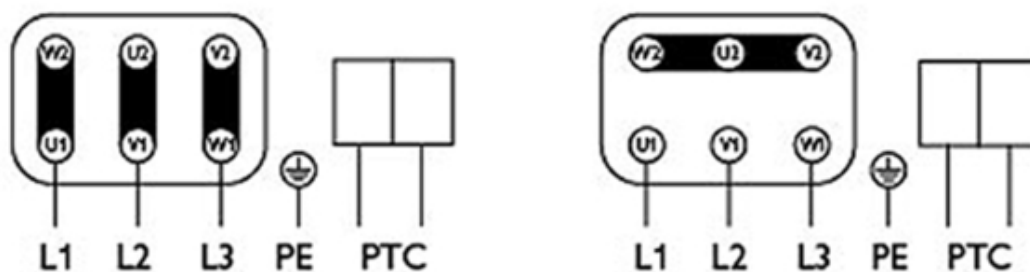

**3 x 230V**  
**D Schaltung**  
**Delta connection**  
**Branchement en triangle**

**3 x 400V**  
**Y Schaltung**  
**Star connection**  
**Branchement en étoile**

**Drehrichtungsänderung durch Vertauschen von 2 Phasen**  
**Changing of direction of rotation by interchanging of two phases**  
**Changement de sens de rotation par inversion de deux phases**

**Typenschild beachten! See label! Voir plaque!**

**Accessories**



**Electric accessories**

- [Trigger unit U-EK230E \(30199\)](#)
- [REV-5POL/05 ON/OFF \(33979\)](#)
- [REV-9POL/12 ON/OFF \(33981\)](#)
- [REV-5POL/05 incl. EMC KIT \(34549\)](#)
- [FRQ5S-10A+LED V2 \(36234\)](#)
- [FRQ5-10A+LED V2 \(36230\)](#)
- [FRQS-10A V2 \(36232\)](#)
- [FRQ-10A V2 \(36228\)](#)
- [FXDM8AM Frequency inv. IP54 \(31388\)](#)



**Accessories**

- [ASS-P 250 flex. con. PRF \(32368\)](#)
- [VKA-P 250 adjust. damper PRF \(32373\)](#)
- [VKS-P 250 gravity shutter PRF \(32378\)](#)
- [VP-Splinter protection PRF 250 \(305465\)](#)
- [SD rubber mou. 4Pcs PRF160-250 \(32568\)](#)
- [WSD PRF250 Weather roof KIT \(309460\)](#)

**Documentation**

-  [manual\\_prf, prf ex\\_en\\_005.pdf \(531,63kB\)](#)
-  [ec-dec\\_prf\\_171114\\_de, gb\\_003.pdf \(549,34kB\)](#)
-  [compatibility with chemical agents\\_en\\_003.pdf \(64,78kB\)](#)

**Get In Touch**

 **Call:** [0845 6880112](tel:08456880112)  
 **Email:** [info@adremit.co.uk](mailto:info@adremit.co.uk)

**Our Address**

Puravent, Adremit Limited, Unit 5a, Commercial Yard,  
 Settle, North Yorkshire, BD24 9RH



## Specification text

---

Name: **PRF 250D2 IE3** | Item no.: **87991**

5 / 5

Document type: **Product card** | Document date: **2019-07-02** | Generated by: **Online catalogue**

### Get In Touch



Call: [0845 6880112](tel:08456880112)



Email: [info@adremit.co.uk](mailto:info@adremit.co.uk)

### Our Address

Puravent, Adremit Limited, Unit 5a, Commercial Yard,  
Settle, North Yorkshire, BD24 9RH