



## PRF 200D2 IE3

Item no. 87990

Document type: **Product card**

Document date: **2019-07-02**

Generated by: **Systemair Online Catalogue**

### Description

- High efficient motor IE3
- Speed-controllable via frequency converter
- Integral cold conductor (PTC)
- Standard motor outside the air stream
- Temperature of transported air from -15°C - +70°C
- Position of casing can be easily adapted
- Single-flow impellers from PP with effective blade geometry
- Low sound level
- The powder painted pedestal is manufactured of galvanized steel
- Perfect fitting accessories: connections, dampers, splinter protection
- Easy to maintain and reliable

The PRF fans are equipped with high efficient IE3 motors. The PRF fans have been developed especially for the exhaust of aggressive media. This is the right fan when corrosive gases, contaminated air or other aggressive components are part of the exhaust air. Typical applications are medical facilities, the food-, electrical-or chemical industry. Speed control is only possible by using a frequency converter. Motor protection is done by cold conductors (PTC), which have to be connected to an external motor protection device.

The sintered casing is from UV-resistant PE and offers a variety of applications with its connectors from ø 125 - 250 mm. The casing can be easily adjusted through turning it (Standard position is LG270, see picture).



### Technical parameters

Nominal data		
Voltage	400	V
Frequency	50	Hz
Phase	3	~
Input power (P1)	1572	W
Current	2,6	A
Max. airflow	0,609	m³/s
R.p.m.	2886	r.p.m.
Weight	28	kg
Temperature data		
Max. temperature of transported air	70	°C
Sound data		
Sound pressure level at 3 m	73	dB(A)
Protection / Classification		
Insulation class	F	
Enclosure class, motor	IP55	

#### Get In Touch

Call: [0845 6880112](tel:08456880112)  
 Email: [info@adremit.co.uk](mailto:info@adremit.co.uk)

#### Our Address

Puravent, Adremit Limited, Unit 5a, Commercial Yard,  
 Settle, North Yorkshire, BD24 9RH

## Diagrams

### Diagrams

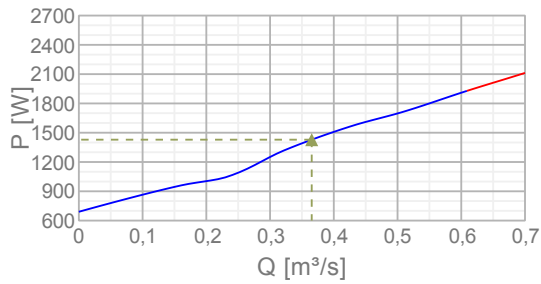
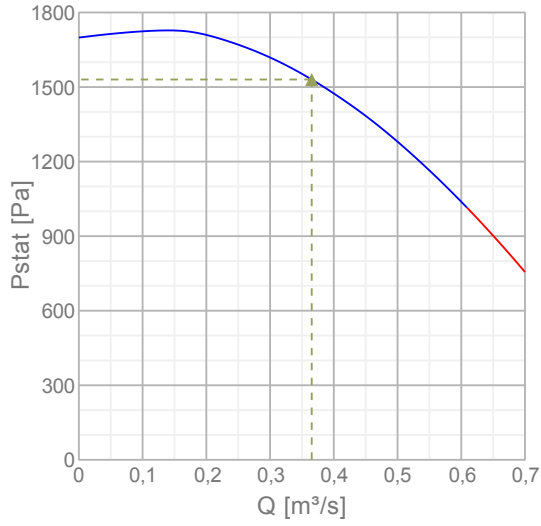

### Max efficiency

Hydraulic data										
▲ Working air flow	0,365 m³/s									
▲ Working static pressure	1530 Pa									
▲ Power	1429 W									
Speed	2896 r.p.m.									
Current	2,41 A									
SFP	3,91 W/(l/s)									
Voltage	400 V									
Sound power level		63	125	250	500	1k	2k	4k	8k	Tot
Inlet	dB(A)	58	73	73	79	78	76	66	57	84
Outlet	dB(A)	59	74	75	81	79	77	68	58	85

Name: **PRF 200D2 IE3** | Item no.: **87990**

Document type: **Product card** | Document date: **2019-07-02** | Generated by: **Online catalogue**

2 / 5

### Get In Touch

 **Call:** [0845 6880112](tel:08456880112)  
 **Email:** [info@adremit.co.uk](mailto:info@adremit.co.uk)

### Our Address

Puravent, Adremit Limited, Unit 5a, Commercial Yard,  
Settle, North Yorkshire, BD24 9RH

## Dimensions

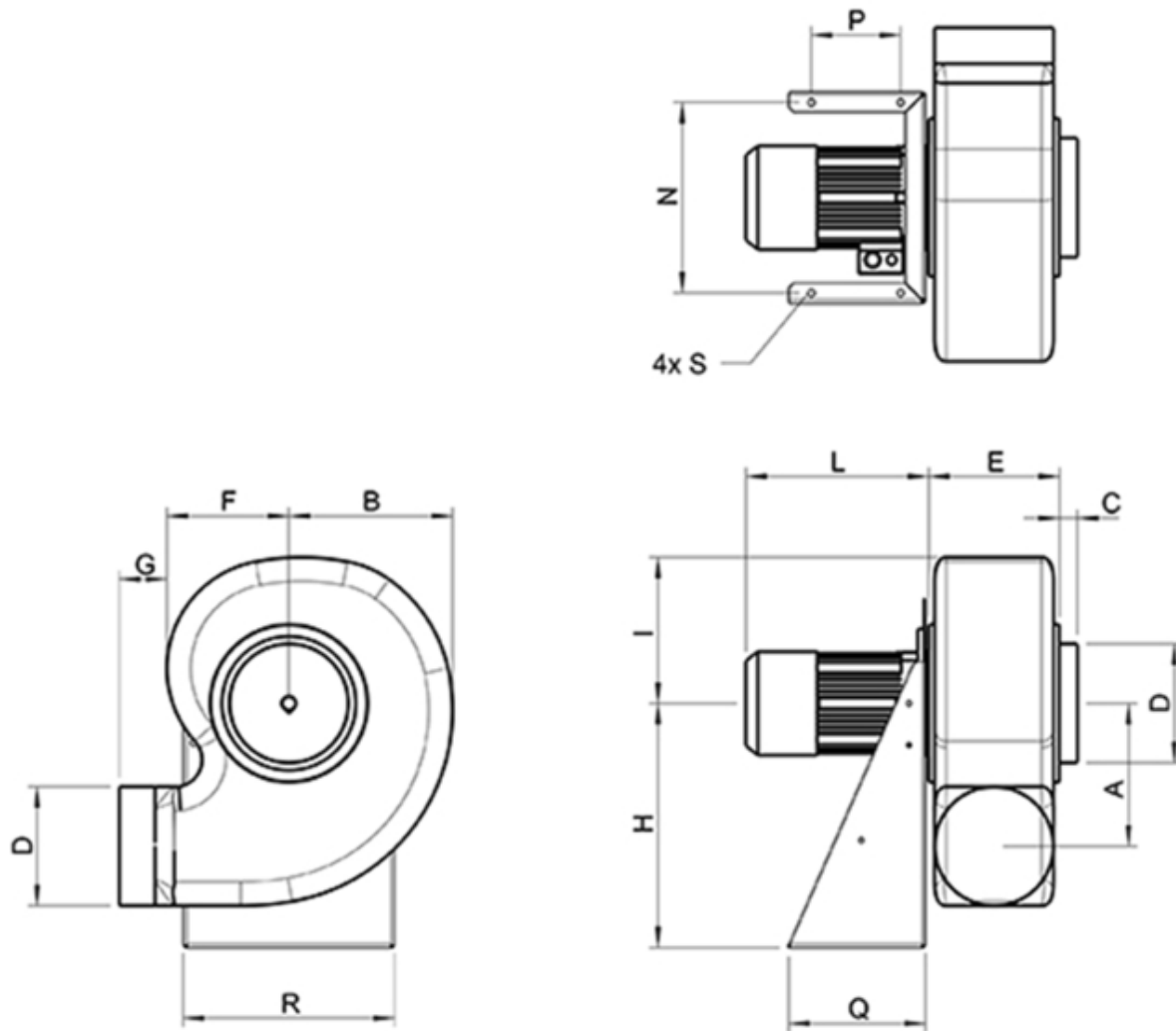

	A	B	C	∅D	E	F	G	H	I	L	N	P	Q	R
PRF 200D2	230	310	40	200	170	220	60	410	245	210	320	150	230	355



Total height= 655mm

Name: **PRF 200D2 IE3** | Item no.: **87990**

Document type: **Product card** | Document date: **2019-07-02** | Generated by: **Online catalogue**

3 / 5

### Get In Touch

 Call: [0845 6880112](tel:08456880112)  
 Email: [info@adremit.co.uk](mailto:info@adremit.co.uk)

### Our Address

Puravent, Adremit Limited, Unit 5a, Commercial Yard,  
Settle, North Yorkshire, BD24 9RH

**Dreiphasenmotor mit Kaltleiter**  
**Three phase motor with cold conductor**  
**Moteur triphasé avec résistance PTC**

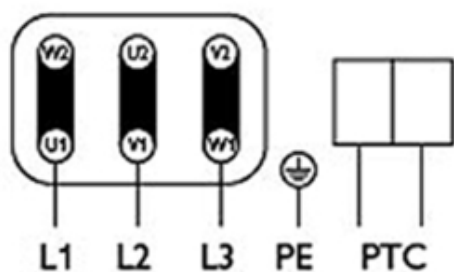

**3 x 230V**  
**D Schaltung**  
**Delta connection**  
**Branchement en triangle**

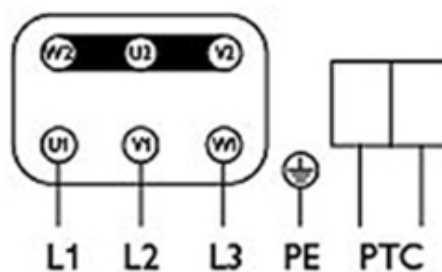

**3 x 400V**  
**Y Schaltung**  
**Star connection**  
**Branchement en étoile**

**Drehrichtungsänderung durch Vertauschen von 2 Phasen**  
**Changing of direction of rotation by interchanging of two phases**  
**Changement de sens de rotation par inversion de deux phases**

**Typenschild beachten! See label! Voir plaque!**

**Accessories**



**Electric accessories**

- [Trigger unit U-EK230E \(30199\)](#)
- [REV-5POL/05 ON/OFF \(33979\)](#)
- [REV-9POL/12 ON/OFF \(33981\)](#)
- [REV-5POL/05 incl. EMC KIT \(34549\)](#)
- [FRQ-4A V2 \(36227\)](#)
- [FRQ5-4A+LED V2 \(36229\)](#)
- [FRQ5S-4A+LED V2 \(36233\)](#)
- [FRQS-4A V2 \(36231\)](#)
- [FXDM5AM Frequency inv. IP54 \(31387\)](#)

**Accessories**

- [ASS-P 200 flex. con. PRF \(32366\)](#)
- [VKA-P 200 adjust. damper PRF \(32371\)](#)
- [VKS-P 200 gravity shutter PRF \(32376\)](#)
- [VP-Splinter protection PRF 200 \(305464\)](#)
- [SD rubber mou. 4Pcs PRF160-250 \(32568\)](#)
- [WSD PRF200 Weather roof KIT \(309459\)](#)

**Documentation**

-  [manual\\_prf\\_prf\\_ex\\_en\\_005.pdf \(531,63kB\)](#)
-  [ec-dec\\_prf\\_171114\\_de\\_gb\\_003.pdf \(549,34kB\)](#)
-  [compatibility with chemical agents\\_en\\_003.pdf \(64,78kB\)](#)

**Get In Touch**

 **Call:** [0845 6880112](tel:08456880112)  
 **Email:** [info@adremit.co.uk](mailto:info@adremit.co.uk)

**Our Address**

Puravent, Adremit Limited, Unit 5a, Commercial Yard,  
 Settle, North Yorkshire, BD24 9RH



## Specification text

---

Name: **PRF 200D2 IE3** | Item no.: **87990**

5 / 5

Document type: **Product card** | Document date: **2019-07-02** | Generated by: **Online catalogue**

### Get In Touch



Call: [0845 6880112](tel:08456880112)



Email: [info@adremit.co.uk](mailto:info@adremit.co.uk)

### Our Address

Puravent, Adremit Limited, Unit 5a, Commercial Yard,  
Settle, North Yorkshire, BD24 9RH