



PRF 180D2 IE3

Item no. 87989

Description

- High efficient motor IE3
- Speed-controllable via frequency converter
- Integral cold conductor (PTC)
- Standard motor outside the air stream
- Temperature of transported air from -15°C - +70°C
- Position of casing can be easily adapted
- Single-flow impellers from PP with effective blade geometry
- Low sound level
- The powder painted pedestal is manufactured of galvanized steel
- Perfect fitting accessories: connections, dampers, splinter protection
- Easy to maintain and reliable

The PRF fans are equipped with high efficient IE3 motors. The PRF fans have been developed especially for the exhaust of aggressive media. This is the right fan when corrosive gases, contaminated air or other aggressive components are part of the exhaust air. Typical applications are medical facilities, the food-, electrical-or chemical industry. Speed control is only possible by using a frequency converter. Motor protection is done by cold conductors (PTC), which have to be connected to an external motor protection device.

The sintered casing is from UV-resistant PE and offers a variety of applications with its connectors from ø 125 - 250 mm. The casing can be easily adjusted through turning it (Standard position is LG270, see picture).



Technical parameters

Nominal data		
Voltage	400	V
Frequency	50	Hz
Phase	3	~
Input power (P1)	742	W
Current	1,54	A
Max. airflow	0,562	m³/s
R.p.m.	2944	r.p.m.
Weight	20,5	kg
Temperature data		
Max. temperature of transported air	70	°C
Sound data		
Sound pressure level at 3 m	68	dB(A)
Protection / Classification		
Insulation class	F	
Enclosure class, motor	IP55	

Get In Touch

Call: [0845 6880112](tel:08456880112)
 Email: info@adremit.co.uk

Our Address

Puravent, Adremit Limited, Unit 5a, Commercial Yard,
 Settle, North Yorkshire, BD24 9RH

Diagrams

Diagrams

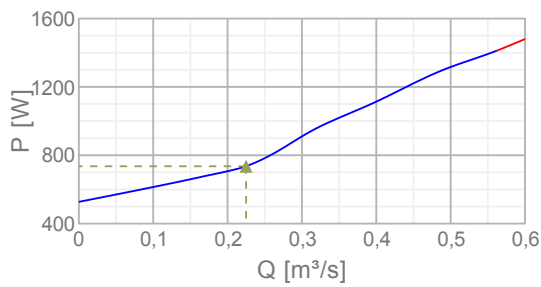
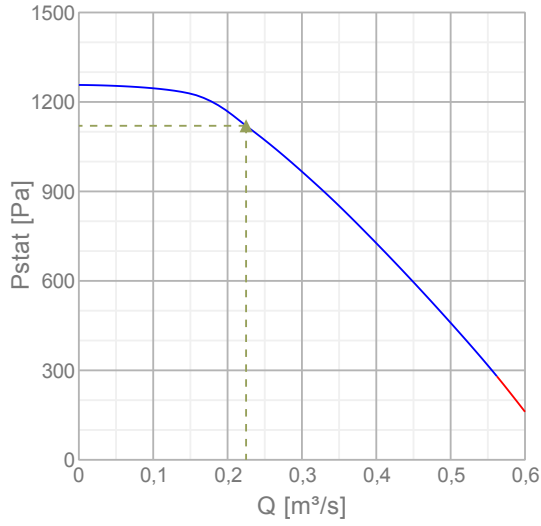

Max efficiency

Hydraulic data										
▲ Working air flow										0,225 m³/s
▲ Working static pressure										1120 Pa
▲ Power										736 W
Speed										2945 r.p.m.
Current										1,53 A
SFP										3,27 W/(l/s)
Voltage										400 V
Sound power level		63	125	250	500	1k	2k	4k	8k	Tot
Inlet	dB(A)	51	68	69	75	80	72	75	64	83
Outlet	dB(A)	52	69	71	76	82	74	76	65	84

Get In Touch

 Call: [0845 6880112](tel:08456880112)
 Email: info@adremit.co.uk

Our Address

Puravent, Adremit Limited, Unit 5a, Commercial Yard,
Settle, North Yorkshire, BD24 9RH

Dimensions

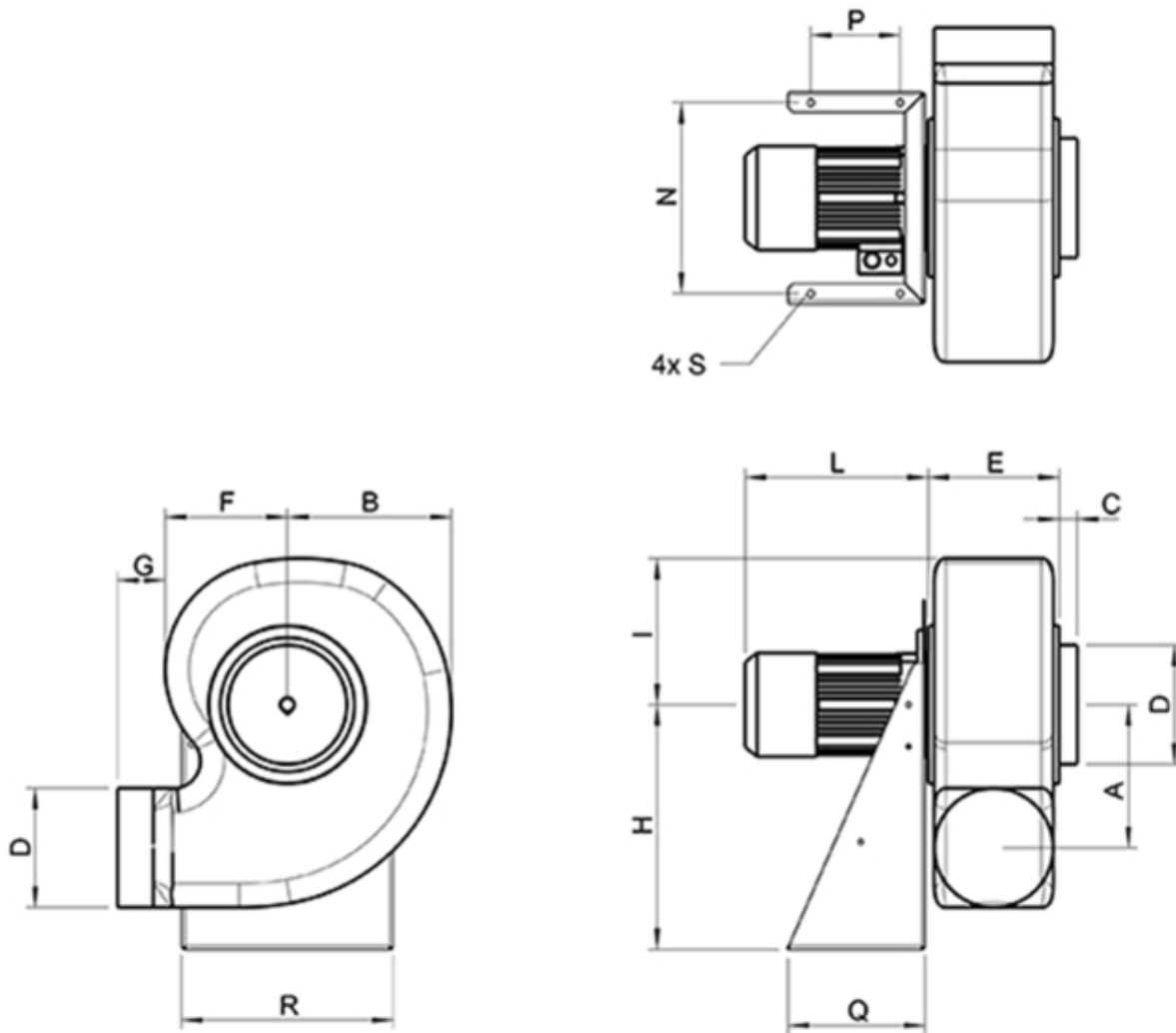

	A	B	C	øD	E	F	G	H	I	L	N	P	Q	R
PRF 180D2	208	274	40	180	160	204	60	350	230	230	277	120	190	316



Total heigh= 580mm

Name: **PRF 180D2 IE3** | Item no.: **87989**

3 / 5

Document type: **Product card** | Document date: **2019-07-02** | Generated by: **Online catalogue**

Get In Touch

 Call: [0845 6880112](tel:08456880112)
 Email: info@adremit.co.uk

Our Address

Puravent, Adremit Limited, Unit 5a, Commercial Yard,
Settle, North Yorkshire, BD24 9RH

Dreiphasenmotor mit Kaltleiter
Three phase motor with cold conductor
Moteur triphasé avec résistance PTC

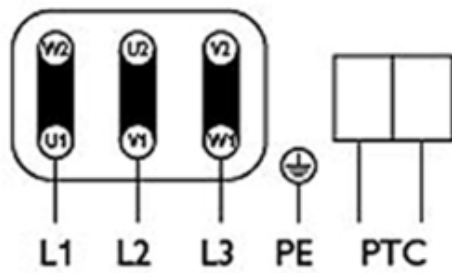

3 x 230V
D Schaltung
Delta connection
Branchement en triangle

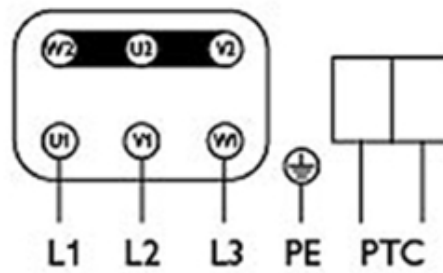

3 x 400V
Y Schaltung
Star connection
Branchement en étoile

Drehrichtungsänderung durch Vertauschen von 2 Phasen
Changing of direction of rotation by interchanging of two phases
Changement de sens de rotation par inversion de deux phases

Typenschild beachten! See label! Voir plaque!

Accessories



Electric accessories

- [Trigger unit U-EK230E \(30199\)](#)
- [REV-5POL/05 ON/OFF \(33979\)](#)
- [REV-9POL/12 ON/OFF \(33981\)](#)
- [REV-5POL/05 incl. EMC KIT \(34549\)](#)
- [FRQ-4A V2 \(36227\)](#)
- [FRQ5-4A+LED V2 \(36229\)](#)
- [FRQ5S-4A+LED V2 \(36233\)](#)
- [FRQS-4A V2 \(36231\)](#)
- [FXDM5AM Frequency inv. IP54 \(31387\)](#)



Accessories

- [ASS-P 180 flex. con. PRF \(32379\)](#)
- [VKA-P 180 adjust. damper PRF \(32380\)](#)
- [VKS-P 180 gravity shutter PRF \(32381\)](#)
- [VP-Splinter protection PRF 180 \(305463\)](#)
- [SD rubber mou. 4Pcs PRF160-250 \(32568\)](#)
- [WSD PRF180 Weather roof KIT \(309458\)](#)

Documentation

-  [manual_prf_prf_ex_en_005.pdf \(531,63kB\)](#)
-  [ec-dec_prf_171114_de_gb_003.pdf \(549,34kB\)](#)
-  [compatibility with chemical agents_en_003.pdf \(64,78kB\)](#)

Get In Touch

-  **Call:** [0845 6880112](tel:08456880112)
-  **Email:** info@adremite.co.uk

Our Address

Puravent, Adremite Limited, Unit 5a, Commercial Yard,
 Settle, North Yorkshire, BD24 9RH



Specification text

Name: **PRF 180D2 IE3** | Item no.: **87989**

5 / 5

Document type: **Product card** | Document date: **2019-07-02** | Generated by: **Online catalogue**

Get In Touch



Call: [0845 6880112](tel:08456880112)



Email: info@adremit.co.uk

Our Address

Puravent, Adremit Limited, Unit 5a, Commercial Yard,
Settle, North Yorkshire, BD24 9RH