



PREHEAT. KIT TOPVEX CB315 EL

Item no. 131010

Document type: **Product card**
 Document date: **2019-07-02**
 Generated by: **Systemair Online Catalogue**

Description

A pre-heater is available as an accessory for Systemair Topvex units with counter flow heat exchanger. The pre-heater will compensate the lack of reheater capacity during bypass de-icing.

The pre-heater is connected to the Topvex Corrigo control and will be engaged only (default*) during bypass defrosting mode, to secure supply temperature. Depending of air flow and heating coil capacity the set point for the pre-heater can be set and optimized from the Corrigo control. (Set point is determined according to lack of reheater capacity during bypass de-icing.)

*(optional function settings can be selected from Corrigo menu. In example, conditioned outdoor air temperature)

The kit contains of 1 expansion module, 1 pre-heater, 1 outdoor air sensor and 1 instruction.



Technical parameters

Rating data	
Voltage	400 V
Phase	3 ~
Power	9 kW
Current	13 A
Weight	7 kg

Heating capacity

Dimensions

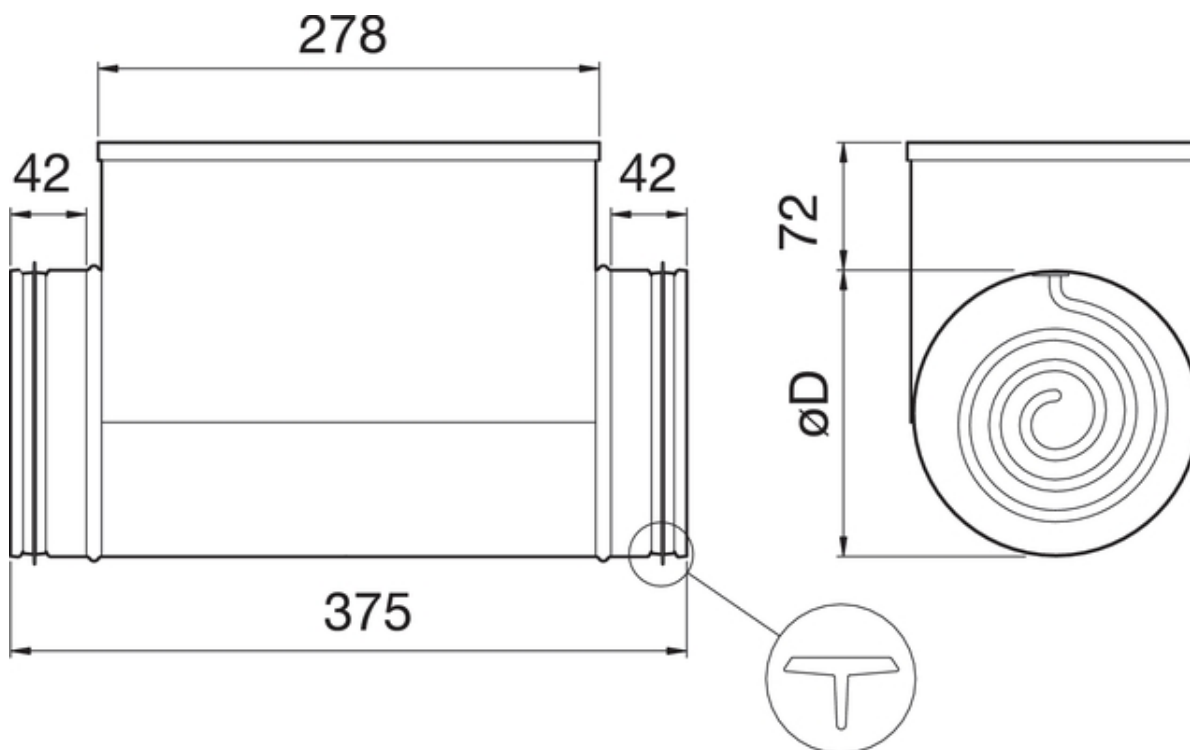

Get In Touch

Call: [0845 6880112](tel:08456880112)
 Email: info@adremit.co.uk

Our Address

Puravent, Adremit Limited, Unit 5a, Commercial Yard,
 Settle, North Yorkshire, BD24 9RH



ø D = 315 mm

Accessories

Documentation



CB-MQXL 173046-01_IMO.pdf (338,52kB)



Pre_heater_installation_counter_flow_134351_EN_A003.pdf (3,24MB)

Name: **PREHEAT. KIT TOPVEX CB315 EL** | Item no.: **131010**

2 / 2

Document type: **Product card** | Document date: **2019-07-02** | Generated by: **Online catalogue**

Get In Touch



Call: [0845 6880112](tel:08456880112)



Email: info@adremit.co.uk

Our Address

Puravent, Adremit Limited, Unit 5a, Commercial Yard,
Settle, North Yorkshire, BD24 9RH