

PCA1000/6000D2

Sensor-control module for differential pressure and volume

Operating Instructions

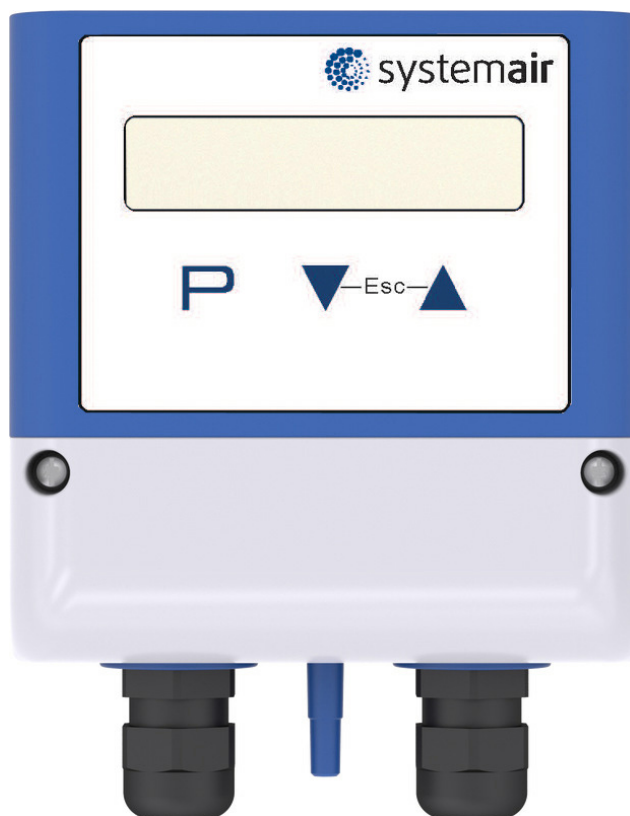

Keep for reference!

Software version: D4753A from version 1.00

L-BAL-E263-GB 1551 Index 001 Part.-No. 00163445-42



Get In Touch

 Call: [0845 6880112](tel:08456880112)
 Email: info@adremit.co.uk



Our Address

Puravent, Adremit Limited, Unit 5a, Commercial Yard,
Settle, North Yorkshire, BD24 9RH

Content

1	General notes	4
1.1	Structure of the operating instructions	4
1.2	Exclusion of liability	4
2	Safety instructions	4
3	Product overview	5
3.1	Function	5
3.2	Storage	6
3.3	Disposal / recycling	6
4	Mounting	7
5	Electrical installation	8
5.1	EMC-compatible installation of control lines	8
5.2	Connection Voltage supply	8
5.3	Output voltage 0 - 10 V	8
5.4	Input for switch over Setpoint 1/ 2	9
6	Connection and operating elements	10
7	Programming	11
7.1	Select operation mode	11
7.2	Start-up	11
7.3	Menu structure	12
7.4	Display unit (metric / inch)	13
7.5	Parameter table	14
7.6	Nozzle coefficient (K-Factor)	16
7.7	Zero point adjustment (Autozero / Offset)	16
7.8	Check sensor function	17
8	Enclosure	17
8.1	Technical data	17

Get In Touch

 **Call:** [0845 6880112](tel:08456880112)
 **Email:** info@adremit.co.uk

Our Address

Puravent, Adremit Limited, Unit 5a, Commercial Yard,
Settle, North Yorkshire, BD24 9RH



8.2	Connection diagram	19
8.3	Dimensions [mm]	19
8.4	Manufacturer reference	20

Get In Touch

 **Call:** [0845 6880112](tel:08456880112)
 **Email:** info@adremit.co.uk

Our Address

Puravent, Adremit Limited, Unit 5a, Commercial Yard,
Settle, North Yorkshire, BD24 9RH

1 General notes

1.1 Structure of the operating instructions

Before installation and start-up, read this manual carefully to ensure correct use!

We emphasize that these operating instructions apply to specific units only, and are in no way valid for the complete system!

Use these operating instructions to work safely with and on the device. They contain safety instructions that must be complied with as well as information that is required for failure-free operation of the device.

Keep these operating instructions together with the device. It must be ensured that all persons that are to work on the device can refer to the operating instructions at any time.

1.2 Exclusion of liability

To allow for future developments, construction methods and technical data given are subject to alteration. We do not accept any liability for possible errors or omissions in the information contained in data, illustrations or drawings provided.

We accept no liability for damage caused by misuse, incorrect use, improper use or as a consequence of unauthorized repairs or modifications.



2 Safety instructions



Attention!

- Mounting, electrical connection, and start-up operation may only be carried out by an electrical specialist in accordance with electrotechnical regulations (e.g. DIN EN 50110 or DIN EN 60204)!
- Persons entrusted with the planning, installation, commissioning and maintenance and servicing in connection with the device must have the corresponding qualifications and skills for these jobs. In addition, they must be knowledgeable about the safety

Get In Touch

 Call: 0845 6880112
 Email: info@adremit.co.uk

Our Address

Puravent, Adremit Limited, Unit 5a, Commercial Yard,
Settle, North Yorkshire, BD24 9RH

regulations, EU directives, rules for the prevention of accidents and the corresponding national as well as regional and in-house regulations.

- It is strictly forbidden for work to be carried out on any components while they are connected to live voltage.
- The safe isolation from the supply must be checked using a two-pole voltage detector.
- The owner is obliged to ensure that the device is operated in perfect working order only.
- Inspect electrical equipment periodically: retighten loose connections – immediately replace damaged lines and cables.
- Never clean electrical equipment with water or similar liquids.
- A separate fault and performance monitoring-system with an alarm signal function is necessary in order to prevent personal injuries and material damages during malfunctions and in case the device fails. Substitute operation must be taken into consideration!

Intended use

These devices are intended exclusively for measured value acquisition of differential pressures (non-aggressive gases). Their operation is only permitted under observance of the specifications in these operating instructions.



Any other use above and beyond this will be considered as improper use. The manufacturer will not be liable for any damage resulting from this. The company using it bears the sole risk.

3 Product overview

3.1 Function

Sensor-control module with differential-pressure sensors in proven ceramic-cantilever technology for climate and clean-room application.

Get In Touch

 **Call:** [0845 6880112](tel:08456880112)
 **Email:** info@adremit.co.uk

Our Address

Puravent, Adremit Limited, Unit 5a, Commercial Yard,
Settle, North Yorkshire, BD24 9RH

The pressure range from 0 to 6000 Pa (24 in.wg) is covered with 2 types of device. With each type four measuring ranges are programmable.

Function when the pressure at the “Plus”- connection exceeds the pressure at the “Minus”- connection.

Depending on the programmed Mode the device can be used as sensor or as a control module for pressure or volume.

- For operation as pressure sensor the device supplies an output signal (0...10 V) proportional to the measuring range.
- For operation as air volume sensor the device supplies an output signal (0..10 V) proportional to the air volume measuring range (☞ INFO / Range qV). Function in combination with centrifugal fans and measuring device in the inlet ring. The controller calculates the air volume of the fan from the “K-Factor” and pressure differential between the suction side and the inlet duct.
- For operation as control module for pressure or volume the purpose of the device is to reach and maintain the target value set. To accomplish this, the measured actual value (sensor value) is compared with the adjusted target value, and the controlled value is deduced from this. Controlled output (0...10 V) e.g. for activating a speed controller for fans or an EC-fan directly.

3.2 Storage

- The device must be stored in its original packaging in a dry and weather-proof room.
- Avoid exposure to extreme heat and cold.
- Avoid over-long storage periods (we recommend a maximum of one year).

3.3 Disposal / recycling



Disposal must be carried out professionally and in an environmentally friendly way in accordance with the respective national legal stipulations.

Get In Touch

☎ Call: 0845 6880112
✉ Email: info@adremit.co.uk

Our Address

Puravent, Adremit Limited, Unit 5a, Commercial Yard,
Settle, North Yorkshire, BD24 9RH

- ▷ Separate the materials by type and in an environmentally friendly way.
- ▷ If necessary, commission a specialist company with the waste disposal.

4 Mounting

- Before installation remove the device from the packing and check for any possible shipping damage!
- Assemble the device on a clean and stable base. Do not distort during assembly! Use the appropriate mounting devices for proper installation of the unit!
- Use the templates printed on the device packing to mark the fastening bore holes.
- The pressure measuring depends on position, therefore the mounting must be made vertical and as possible on a vibration-free place (cable inlet and pressure connections down).
- The pressure line's connection should be with plastic-hose (in building), inside diameter 4 / 5 mm. For a firm hold of the hose, its inside diameter must be 1 mm smaller than the outside diameter of the hose nozzle (step spigot 5 / 6 mm).
- Remove the connection cover for mounting, electrical connection and setting of the measuring range. Close the lid again carefully before start-up (tightening torque of the lid screws 1.1 Nm).

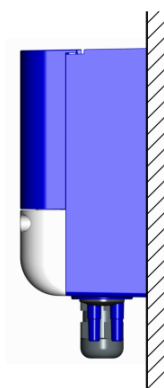

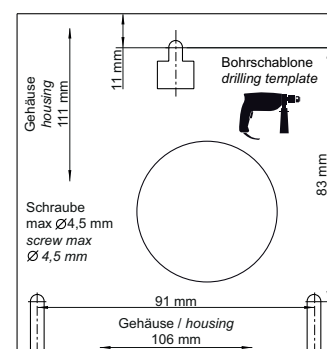

Vertical mounting



Drilling template on packing

Get In Touch

 Call: 0845 6880112
 Email: info@adremit.co.uk

Our Address

Puravent, Adremit Limited, Unit 5a, Commercial Yard,
Settle, North Yorkshire, BD24 9RH

5 Electrical installation

5.1 EMC-compatible installation of control lines

Pay attention to maintain sufficient distance from powerlines and motor wires to prevent interferences.

When using a shielded cable the shield must be connected (as short and with as low an induction as possible!) to the PE conductor on one side at the signal input (of the evaluation unit).

5.2 Connection Voltage supply

Connection Voltage supply at terminals: “+U_S” and “GND”. Here, it must be strictly observed that the mains voltage lies within the allowable tolerance specifications (☞ Technical data and nameplate affixed to the side).



Danger due to electric current

Only PELV current sources which ensure safe electrical isolation of the operating voltage in accordance with IEC/DIN EN 60204-1 must be used.

There is no potential isolation between supply voltage and output signal.

5.3 Output voltage 0 - 10 V

Connection to Terminals “A” - “GND” (I_{max}☞ Technical data).

It is not permissible to connect outputs of several devices to each other!

Get In Touch

 Call: 0845 6880112
 Email: info@adremit.co.uk

Our Address

Puravent, Adremit Limited, Unit 5a, Commercial Yard,
Settle, North Yorkshire, BD24 9RH

5.4 Input for switch over Setpoint 1/ 2

Via voltage at terminals “1” and “2” (10... 24 V DC) a switchover between Setpoint 1 and Setpoint 2 is possible (note polarity  connection diagram).

- Voltage OFF => Setting “Setpoint 1” active
- Voltage ON => Setting “Setpoint 2” active

Setpoint 1 active



100 Pa
(0.401 in.wg)
Δp

The active Setpoint is indicated in the menu INFO, an active “Setpoint 2” is signaled by the moon symbol.

Setpoint 2 active

80 Pa
(0.321 in.wg)
Δp 

Get In Touch

 Call: [0845 6880112](tel:08456880112)
 Email: info@adremi.co.uk

Our Address

Puravent, Adremi Limited, Unit 5a, Commercial Yard,
Settle, North Yorkshire, BD24 9RH

6 Connection and operating elements

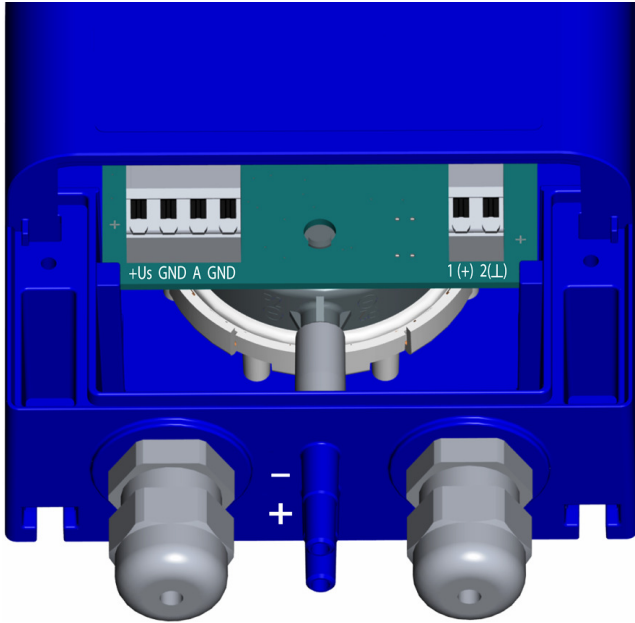
	+U _S / GND	Voltage supply
	A / GND	Output signal 0...10 V
	1 / 2	Voltage input for switch over Set-point 1 / 2
	-	“Minus”- connection in area with lower pressure
	+	“Plus”- connection in area with higher pressure

Multipurpose LC display and keyboard

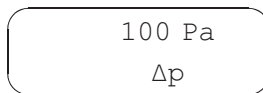

Text line 1: 16 figures for display of actual and desired values
 Text line 2: 16 figures for display of menu text



- P** Program key and open menu
- ▼** Menu selection, reduce value
- ▲** Menu selection, increase value
- ▼ + ▲** ESC-key combination, Escape = leave menu

Messages on the display

!	Exceeding measuring range
☾	Moon symbol = Adjustment for Setpoint 2 active

7 Programming

7.1 Select operation mode



Information

Simple installation is possible through the selection of the preprogrammed mode of operation.

This determines the basic function of the device, factory set **4.01**.

Mode	Function
4.00	Pressure sensor output 0...10 V proportional to measuring range
4.01	Pressure controller (PID): output 0...10 V depending on adjusted Setpoint and measured actual value.
5.00	Air volume sensor: Output 0...10 V proportional to measuring range (depending on setting for K-Factor)
5.01	Air volume controller (PID): Output 0...10 V depending on adjusted Setpoint and measured actual value

7.2 Start-up

Procedure

1. You must mount and connect the device in accordance with the operating instructions.
2. Double check that all connections are correct.
3. The supply voltage must match the information on the rating plate.
4. Set the mode, unit and measuring range and adjust the sensor in the **BASE SETUP**.
5. Set the parameters for control operation for the modes **4.01** and **5.01** under **SETTING**.



Information

When saving the Operating Mode, the factory settings are stored. Therefore all the settings you have made, are lost.

7.3 Menu structure

100 Pa Δp	Display after turning on the voltage supply. Switch over between actual value display and “INFO” with the key shortcut for Escape (Esc = ▼ + ▲).	INFO
--------------	--	------

Selection of the menu group (e.g. BASE SETUP) to the right through the ▼-key, to the left through the ▲-key.

You can go to the menu items in the menu groups (e.g. mode) by using the P key. Use the arrow keys to move up and down within the menu group.

To make adjustments, press the P key after selecting the menu item. If the previously set value starts to flash, it can be adjusted with the ▼ + ▲ keys and then saved with the P key. To exit the menu without making any changes, use the “Esc” short-key, i.e., the originally set values remain.

Example for Mode 4.01 (Factory setting)

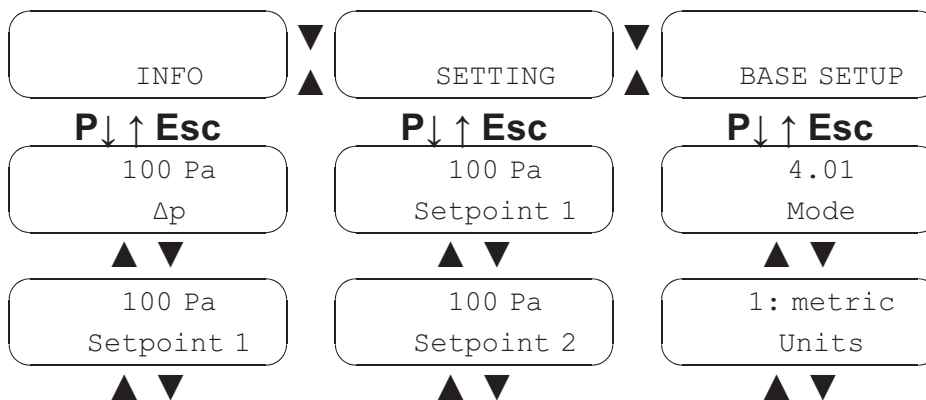

Reprogramming Mode 4.01 to 5.00 in “BASE SETUP”

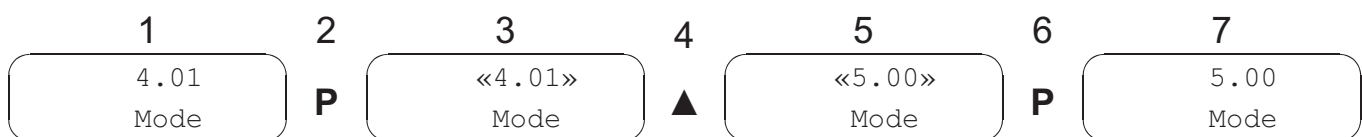

7.4 Display unit (metric / inch)

The display can be switched between SI units (factory setting) and imperial (US) units  BASE SETUP / Units.

Conversion factors

- Pressure: 1.0 in.wg = 254 Pa
- Air flow: 1.0 cfm = 0.5885 m³/h
inlet ring: K-Factor US = 9.3 x K-Factor SI

Get In Touch

 Call: [0845 6880112](tel:08456880112)
 Email: info@adremi.co.uk

Our Address



Puravent, Adremi Limited, Unit 5a, Commercial Yard,
Settle, North Yorkshire, BD24 9RH

7.5 Parameter table

Example for PCA1000D2

Parameter	Display / factory setting				Funktion
	4.00	4.01	5.00	5.01	
Mode	4.00	4.01	5.00	5.01	Mode
INFO					Information
Δp	0 Pa (0.000 in.wg)	0 Pa (0.000 in.wg)	-	-	Display actual value for differential pressure
qV	-	-	0 m ³ /h (0 cfm)	0 m ³ /h (0 cfm)	Display actual value for airflow
Setpoint 1	-	500 Pa (2.000 in.wg)	-	1185 m ³ /h (697 cfm)	Display active Setpoint
Range qV	-	-	2371 m ³ /h (1394 cfm)	2371 m ³ /h (1394 cfm)	Air volume measuring range depending on sensor measuring range and K-Factor
Uout	0.0 V	9.9 V	0.0 V	9.9 V	Magnitude of the output voltage 0...10 V
UNIcon	1.00	1.00	1.00	1.00	Software version
Δp	-	-	0 Pa (0.000 in.wg)	0 Pa (0.000 in.wg)	Display actual value for volume measurement
SETTING 4.01 + 5.01					Setting
Setpoint 1	-	500 Pa (2.000 in.wg)	-	1185 m ³ /h (697 cfm)	Setpoint 1 ¹
Setpoint 2	-	500 Pa (2.000 in.wg)	-	1185 m ³ /h (697 cfm)	Setpoint 2 ¹ (active if voltage at terminals 1, 2)
Pband	-	500 Pa (2.000 in.wg)	-	1185 m ³ /h (697 cfm)	Pband ^{1, 2}
Min. Uout	-	0.0 V	-	0.0 V	Min. output voltage: 0.0...10.0 V (priority over "Max. Uout")

Get In Touch

 Call: 0845 6880112
 Email: info@adremit.co.uk



Our Address

Puravent, Adremit Limited, Unit 5a, Commercial Yard,
Settle, North Yorkshire, BD24 9RH

Parameter	Display / factory setting				Funktion
Max. Uout	-	10.0 V	-	10.0 V	Max. output voltage: 10.0...0.0 V
BASE SETUP					Base setup
Mode	4.00	4.01	5.00	5.01	Mode
Units	metric: Pa, m ³ /h, K-Factor inch: in.wg, cfm, K-Factor US				SI units or Imperial units (US)
Measuring Range	1: 0...1000 Pa (0...4.0 in.wg) 2: 0...500 Pa (0...2.0 in.wg) 3: 0...300 Pa (0...1.2 in.wg) 4: 0...200 Pa (0...0.8 in.wg)				PCA1000D2 Adjustable measuring range
	1: 0...6000 Pa (0...24.0 in.wg) 2: 0...4000 Pa (0...16.0 in.wg) 3: 0...3000 Pa (0...12.0 in.wg) 4: 0...2000 Pa (0...8.0 in.wg)				PCA6000D2 Adjustable measuring range
K-Factor K-Factor US	-	-	75 (697)	75 (697)	Nozzle coefficient (K- Factor)  following table
Autozero	OFF => ON				Automatic "0" offset
Offset	0 Pa (0.000 in.wg)				Sensor offset (auto- matically when "Auto- zero") Setting range: +/- - 1000 Pa (+/- 4.000 in.wg)

- 1 Setting range **4.01**: 0..100 % sensor measuring range, **5.01**: 0...Max. Range qV (depending on K-Factor and sensor measuring range)
 2 small value = quick regulation, great value = slow regulation (high stability)
 - Parameter for selected mode not available
 (xxx) Values for Imperial units (US)

Get In Touch

 Call: 0845 6880112
 Email: info@adremit.co.uk

Our Address

Puravent, Adremit Limited, Unit 5a, Commercial Yard,
Settle, North Yorkshire, BD24 9RH

7.6 Nozzle coefficient (K-Factor)

Maximum K-Factor depending on the measuring range of the pressure sensor								
Range [Pa]	200	300	500	1000	2000	3000	4000	6000
[in.wg]	0.8	1.2	2.0	4.0	8.0	12.0	16.0	24.0
Max. K-Factor	4596	3752	2906	2055	1453	1186	1027	839
US	32767	32767	32767	32500	22980	18763	16250	13268

Air volume measuring range [m^3/h], [cfm] depends on selected measuring range of pressure sensor [Pa], [in.wg] and selected “K-Factor (US)”. In menu “INFO” display for “Range qV”. Maximum measuring range at input of each possible maximum “K-Factor (US)”.

Air flow measuring range: max. $65000 \text{ m}^3/\text{h}$ (38257 cfm) depending on setting of measuring range and K-Factor.

7.7 Zero point adjustment (Autozero / Offset)

A zero-point adjustment is possible if the actual value is not “0 Pa Δp ” or “0 m^3/h qV” in pressureless state. A zero point calibration is possible with the function “Autozero”.

This may be necessary, for example, in case of heavy thermal fluctuations in the sensor environment or non-vertical mounting.

Procedure

1. Pull off the pressurised hoses.
2. Switch function “Autozero” in BASE SETUP to “ON” .
3. The display switches to the actual value display and the value “0” is displayed after zero point calibration has taken place.
4. The necessary difference up to “0” is displayed in the BASE SETUP under “Offset”.

Alternatively to the automatic zero point calibration, the offset value can also be set manually  BASE SETUP / Offset.

Get In Touch

 Call: 0845 6880112
 Email: info@adremit.co.uk

Our Address

Puravent, Adremit Limited, Unit 5a, Commercial Yard,
Settle, North Yorkshire, BD24 9RH

7.8 Check sensor function

1. Program Mode **4.00** for pressure sensor.
2. Connect the voltage supply (+U_S / GND), disconnect output 0 ...10 V (A / GND).
3. Remove pressure hoses and measure output signal, nominal = 0 V.
4. Create pressure at the "+" connection against the "-" connection (e. g. by **carefully** blowing in), measure the output signal (0...10 V $\hat{=}$ measuring range).
5. If the sensor works, reconnect the pressure hoses and check these if necessary.

8 Enclosure



8.1 Technical data

Type	PCA1000D2	PCA6000D2
Part-No.	76739 (320064-42)	76740 (320065-42)
Voltage supply	10...24 V DC (+20 %) Protected against reverse polarity	

	@ U _S 10 V DC	@ U _S 13...24 V DC
Max. load output 0...10 V (short-circuit-proof)	0.3 mA	10 mA
Max. current consumption ca.	6 mA	14 mA

Pressure connections "+, -"	Hose connectors d = 5 / 6 mm (0.20 / 0.24 inch)
Housing	PC (polycarbonate) Fire protection classification UL94V0
Use position	vertical (measuring depends on position)
Protection class	IP54 according EN 60529
Weight	approx. 230 g (0.50 lb)

Get In Touch

 Call: 0845 6880112
 Email: info@adremit.co.uk

Our Address

Puravent, Adremit Limited, Unit 5a, Commercial Yard,
Settle, North Yorkshire, BD24 9RH

Permissible temperature range for operation	-10...50 °C (14...122 °F)
Permissible temperature range for storage and transport	-30...50 °C (-22...122 °F)
Permissible rel. humidity	85 % no condensation
One-sided permissible overload	0.1 bar (80 in.wg)
Burst pressure	at room temperature: 0.2 bar (80 in.wg)
	at 70 °C (158 °F): 0.15 bar (60 in.wg)
Maximum cross section of terminals	1.5 mm ² / AWG16
Interference emission	according EN 61000-6-3 (domestic household applications)
Interference immunity	according EN 61000-6-2 (industrial applications)

Accuracy and measuring ranges			
Type		PCA1000D2	PCA6000D2
Pressure measuring range max.		0...1000 Pa (0...4.0 in.wg)	0...6000 Pa (0...24.0 in.wg)
Tolerance zero point max. *)	%	+/- 0.9	+/- 0.9
Tolerance full scale max.	%	+/- 1.3	+/- 0.7
Resolution	%	0.1	0.1
Total of linearity, hysteresis and repeatability max.	%	0.6	0.6
Long term stability according to DIN EN 60770	%	+/- 1.0	+/- 1.0
Temperature coefficient typical	% / 10K	+/- 0.2	+/- 0.2
Temperature coefficient max.	% / 10K	+/- 0.4	+/- 0.4
Temperature coefficient sensitivity typical	% / 10K	+/- 0.2	+/- 0.2
Temperature coefficient sensitivity max.	% / 10K	+/- 0.4	+/- 0.4
The accuracy data are percentages and refer to the maximum possible measuring range of the respective type. Test conditions: 25 °C, 45 % RH, voltage supply 12 VDC			

*) Calibration is possible to reduce the zero point error  zero point calibration

Get In Touch

 Call: 0845 6880112
 Email: info@adremit.co.uk

Our Address

Puravent, Adremit Limited, Unit 5a, Commercial Yard,
Settle, North Yorkshire, BD24 9RH

8.2 Connection diagram

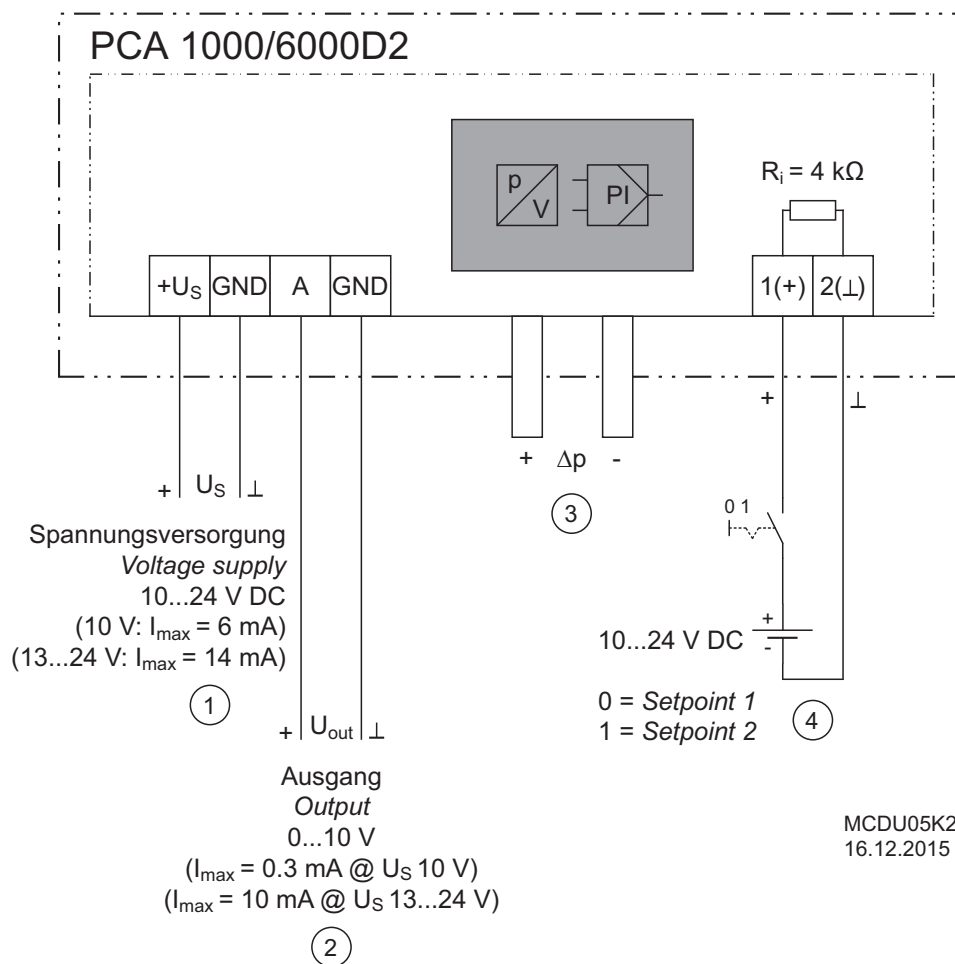

- 1 Voltage supply 10...24 V DC
- 2 Output 0...10 V
- 3 Pressure connections
- 4 Voltage input for switch over Setpoint 1 / Setpoint 2

8.3 Dimensions [mm]

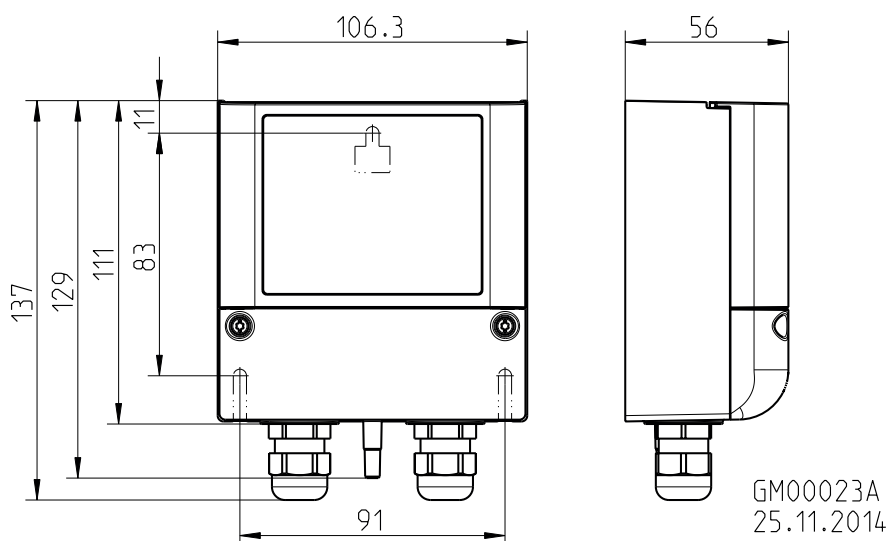

8.4 Manufacturer reference

Our products are manufactured in accordance with the relevant international regulations. If you have any questions concerning the use of our products or plan special uses, please contact:

Systemair

Industrievägen 3

73930 Skinnskatteberg



Telefon:+46 (0) 222 440 00

Telefax:+46 (0) 222 440 99

mailbox@systemair.se

www.systemair.se

Get In Touch

 **Call:** [0845 6880112](tel:08456880112)
 **Email:** info@adremit.co.uk

Our Address

Puravent, Adremit Limited, Unit 5a, Commercial Yard,
Settle, North Yorkshire, BD24 9RH