



K 315 M SILEO**

Item no. 27758

Version: 50 Hz

Document type: **Product card**

Document date: **2019-07-16**

Generated by: **Systemair Online Catalogue**

Description

- Speed-controllable
- Quiet-running
- Increased efficiency
- Integral thermal contacts
- Can be installed in any position
- Can be installed outdoors
- Maintenance-free and reliable

The K Sileo series is designed for installation in ducts. All K-fans have a minimum 25 mm long spigot connections.

The fans have backward-curved blades and external rotor motors. To simplify the installation the K Sileo fan has a fixing bracket together with screws for mounting the bracket included as standard. The FK mounting clamp facilitates easy installation and removal, and prevents the transfer of vibration to the duct. The fans can be speed-controlled via a stepless thyristor or a 5-step transformer.

To protect the motor from overheating the fan has integral thermal contacts with manual reset.

The casing is manufactured from galvanised sheet steel and folded which gives the fan a close to air tight casing. Duct connected outdoor and wet room applications of the fan are possible due to the air tight casing. The K-fans have corrosion class C3.



Technical parameters

Nominal data		
Voltage	230	V
Frequency	50	Hz
Phase	1	~
Input power (P1)	201	W
Current	0,882	A
Max. airflow	0,344	m³/s
R.p.m.	2520	r.p.m.
Weight	5,5	kg
Temperature data		
Max. temperature of transported air	70	°C
Max. temperature of transported air when speed-controlled	70	°C
Sound data		
Sound pressure level at 3 m	47,6	dB(A)
Protection / Classification		
Insulation class		F
Enclosure class, motor		IP44

Get In Touch

Call: [0845 6880112](tel:08456880112)
 Email: info@adremit.co.uk

Our Address

Puravent, Adremit Limited, Unit 5a, Commercial Yard,
 Settle, North Yorkshire, BD24 9RH



Diagrams

Diagrams

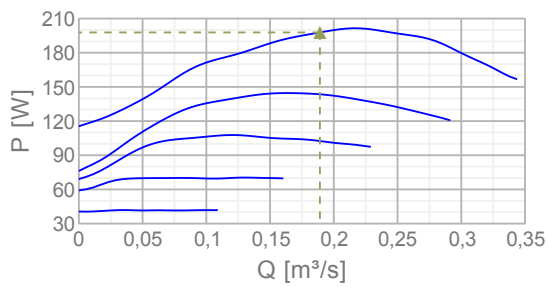
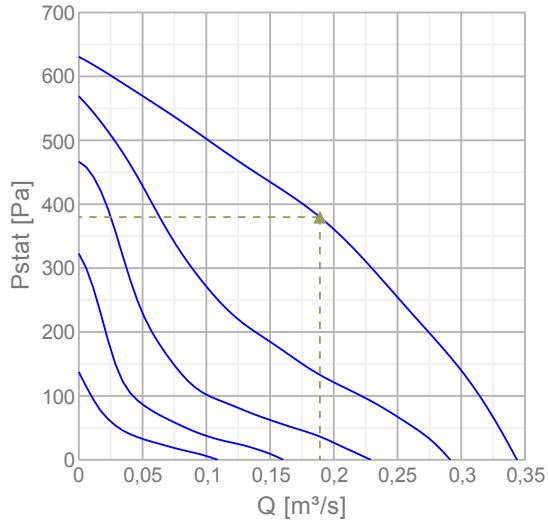

Max efficiency

Hydraulic data										
▲ Working air flow	0,189 m³/s									
▲ Working static pressure	380 Pa									
▲ Power	198 W									
Speed	2521 r.p.m.									
Current	0,869 A									
SFP	1,05 W/(l/s)									
Voltage	230 V									
Sound power level		63	125	250	500	1k	2k	4k	8k	Tot
Inlet	dB(A)	45	60	64	63	65	63	64	54	71
Outlet	dB(A)	50	58	63	60	64	65	64	54	71
Surrounding	dB(A)	16	25	44	46	44	49	46	32	53

Get In Touch

Call: [0845 6880112](tel:08456880112)
 Email: info@adremit.co.uk

Our Address

Puravent, Adremit Limited, Unit 5a, Commercial Yard,
 Settle, North Yorkshire, BD24 9RH

Dimensions

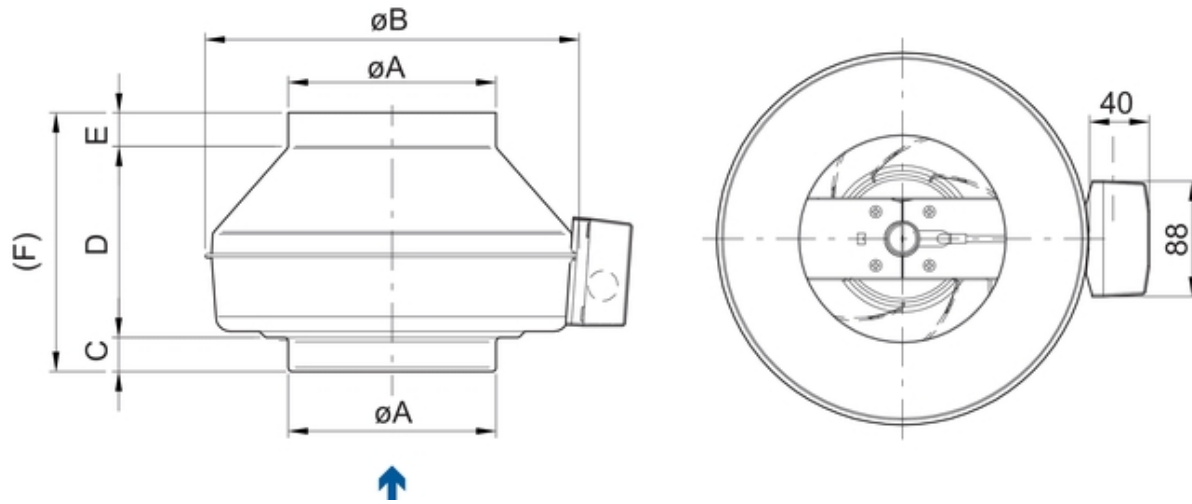

K	$\varnothing A$	$\varnothing B$	C	D	E	F
100 M	99	218	26	166	26	218
100 XL	99	246	26	161	26	213
125 M	124	218	27	142	27	196
125 XL	124	246	26	151	26	203
160 M	159	286	25	147	26	198
160 XL	159	336	29	166	26	221
200 M	199	336	30	148	27	205
200 L	199	336	30	174	27	231
250 M	249	336	30,5	119,5	27	177
250 L	249	336	30,5	144,5	27	202
315 M	314	408	32,5	160,5	27	220
315 L	314	408	38	161	27	225

Accessories

Electric accessories

[RE 1,5 Speed control \(5000\)](#)
[REU 1.5 Speed control \(5004\)](#)
[REE 2 Speed control \(5316\)](#)
[REPT 6 Digital regulator \(5698\)](#)
[RT 0-30 Room Thermostat \(5151\)](#)
[CO2RT-R-D Transmitter \(6993\)](#)
[Presence detector/IR24-P \(6995\)](#)
[RETP 6 Temp/Pressure regulator \(32293\)](#)
[STL 1.5 Speed controller \(84251\)](#)
[REV-3POL/03 ON/OFF \(33978\)](#)
[FRQS-E-6A \(37419\)](#)
[FRQ5S-E-6A \(37421\)](#)
[DTV500A \(96807\)](#)

Accessories



[CB 315-9,0 400V/3 Duct heater \(5375\)](#)
[CB 315-3,0 230V/1 Duct heater \(5386\)](#)
[CB 315-12,0 400V/3 Duct heater \(5387\)](#)
[CBM 315-9,0 400V/3 Duct heater \(5485\)](#)
[VBF 315 Water heating battery \(1734\)](#)
[CWK 315-3-2,5 Duct cooler,circ \(30025\)](#)
[VBC 315-2 Water heating batt \(5461\)](#)
[LDC 315-900 Silencer \(5197\)](#)
[FFR 315 Filter cassette \(1779\)](#)
[FGR 315 Filter cassette \(1818\)](#)
[FK 315 Fast clamp \(1613\)](#)
[VKK-315 Back draft damper \(1628\)](#)
[RSK-315 Back draft damper \(5604\)](#)
[SG 315 Protection guard \(5611\)](#)
[VK-30 Louvre shutter \(5641\)](#)
[VBC 315-3 Water heating batt \(9844\)](#)
[CB 315-6,0 400V/2 Duct heater \(5374\)](#)

Name: **K 315 M SILEO**** | Item no.: **27758** | Version: **50 Hz**

Document type: **Product card** | Document date: **2019-07-16** | Generated by: **Online catalogue**

3 / 4

Get In Touch

 **Call:** [0845 6880112](tel:08456880112)
 **Email:** info@adremit.co.uk

Our Address

Puravent, Adremit Limited, Unit 5a, Commercial Yard,
Settle, North Yorkshire, BD24 9RH

Documentation

 132780_Fans_Instructions_Outside_EU_A002.pdf (1 006,63kB)

 K fan mounting.wmv (3,48MB)

Specification text

Name: **K 315 M SILEO**** | Item no.: **27758** | Version: **50 Hz**

Document type: **Product card** | Document date: **2019-07-16** | Generated by: **Online catalogue**

4 / 4

Get In Touch



Call: [0845 6880112](tel:08456880112)



Email: info@adremit.co.uk

Our Address

Puravent, Adremit Limited, Unit 5a, Commercial Yard,
Settle, North Yorkshire, BD24 9RH