



K 125 EC SILEO

Item no. 16956

Document type: **Product card**
 Document date: **2019-07-16**
 Generated by: **Systemair Online Catalogue**



Description

- EC-motors, high level of efficiency
- 100% speed controllable
- Integrated motor protection
- Supplied with mounting bracket

EC technology is intelligent technology; using integral electronic control which eliminates the slip losses in the motor and ensures that the motor always runs at optimal load and guarantees that the proportion of energy utilised effectively is many times higher and the energy usage considerably lower compared with AC motors.

EC fans are notable for their economical use of energy and excellent ease of control. They can be varied in speed to match the airflow demand, and operate at high efficiency levels. For the same air volume, they consume distinctly less energy than AC fan drives.

Another special feature of EC fans is their energy-saving potential not only at full load, but especially at part-load. When operating at part-load, the energy used is much lower than with an asynchronous motor of equivalent output. Reduced energy usage guarantees a drop in operating costs.

The K EC series is designed for installation in ducts. All the K-fans have minimum 25 mm long spigot connections. The fans have backward-curved blades and external rotor motors (EC). The FK mounting clamp facilitates easy installation and removal, and prevents the transfer of vibration to the duct. The fans are delivered with a pre-wired potentiometer(0-10V) that allows you to easily find the desired working point.

Motor protection is integrated in the electronics of the motor. The casing is manufactured from galvanised sheet steel with the seams folded to give the fan a close to air tight casing. Outdoor mounting and wet room applications are possible due to the fans air tight casing and the IP 55 rated terminal box with a IP 68 rated M20 cable gland.



Technical parameters

Nominal data		
Voltage	230	V
Frequency	50/60	Hz
Phase	1	~
Input power (P1)	83	W
Current	0,678	A
Max. airflow	0,134	m³/s
R.p.m.	3308	r.p.m.
Weight	2,8	kg
Temperature data		
Max. temperature of transported air	60	°C
Max. temperature of transported air when speed-controlled	60	°C
Sound data		
Sound pressure level at 3 m	45,8	dB(A)

Get In Touch

Call: [0845 6880112](tel:08456880112)
 Email: info@adremit.co.uk

Our Address

Puravent, Adremit Limited, Unit 5a, Commercial Yard,
 Settle, North Yorkshire, BD24 9RH



Protection / Classification

Insulation class	B
Enclosure class, motor	IP54

ErP

ErP ready	ErP 2016/ErP 2018
-----------	-------------------

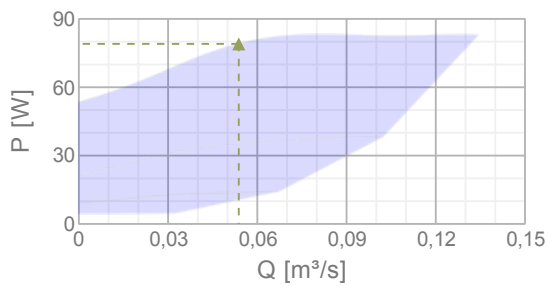
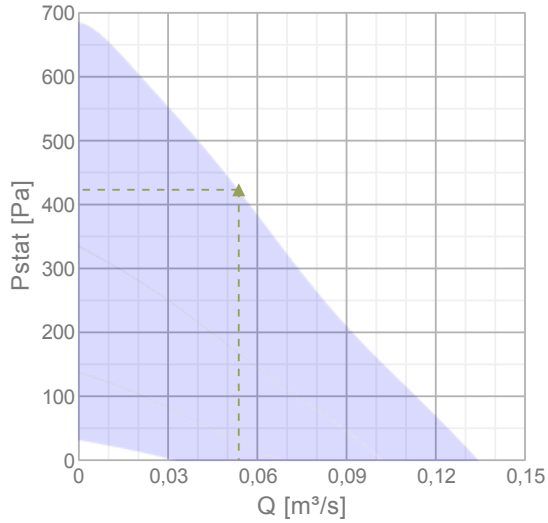
Diagrams**Diagrams****Max efficiency**

Hydraulic data										
▲ Working air flow										0,0538 m³/s
▲ Working static pressure										423 Pa
▲ Power										79 W
Speed										3474 r.p.m.
Current										0,644 A
SFP										1,47 W/(l/s)
Voltage										230 V
Sound power level		63	125	250	500	1k	2k	4k	8k	Tot
Inlet	dB(A)	53	64	75	73	71	66	61	53	79
Outlet	dB(A)	52	65	73	72	68	66	60	52	77
Surrounding	dB(A)	16	13	38	48	48	45	44	34	53

Name: **K 125 EC SILEO** | Item no.: **16956**

2 / 5

Document type: **Product card** | Document date: **2019-07-16** | Generated by: **Online catalogue****Get In Touch**

 **Call:** 0845 6880112
 **Email:** info@adremit.co.uk

Our Address

Puravent, Adremit Limited, Unit 5a, Commercial Yard,
Settle, North Yorkshire, BD24 9RH

Dimensions

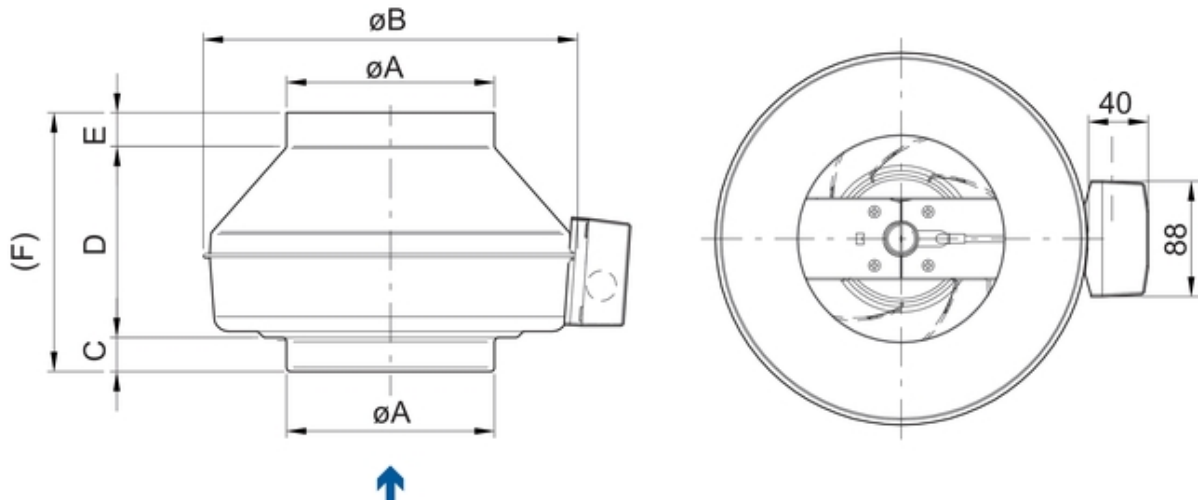

	øA	øB	C	D	E	(F)
K 100 EC	99	246	26	161	26	213
K 125 EC	124	246	26	151	26	203
K 150 EC	149	286	25	152	25	202
K 160 EC	159	286	25	147	26	198
K 200 EC	199	336	30	148	27	205
K 250 EC	249	336	30,5	144,5	27	202
K 315 M EC	314	408	32,5	160,5	27	220
K 315 L EC	314	408	37,5	160,5	27	225

Name: **K 125 EC SILEO** | Item no.: **16956**

Document type: **Product card** | Document date: **2019-07-16** | Generated by: **Online catalogue**

3 / 5

Get In Touch



Call: [0845 6880112](tel:08456880112)



Email: info@adremit.co.uk

Our Address

Puravent, Adremit Limited, Unit 5a, Commercial Yard,
Settle, North Yorkshire, BD24 9RH

Wiring

230V 1~

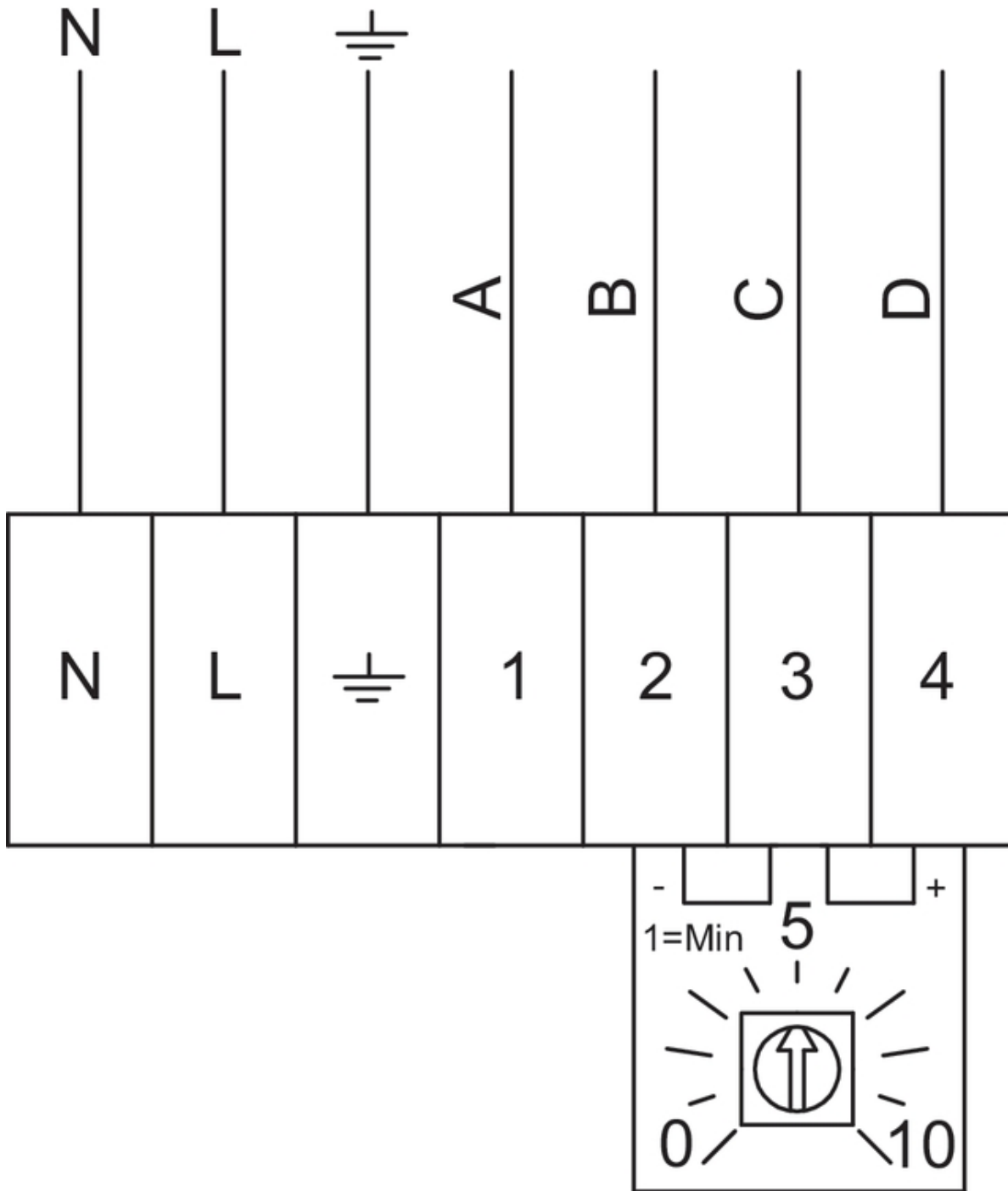

Terminal	Cable	Description
1	White	Tacho output, Isink max 10mA
2	Blue	GND
3	Yellow	Control input 0-10 VDC/PWM
4	Red	Output 10 VDC max 1.1 mA



Internal potentiometer, default

Name: **K 125 EC SILEO** | Item no.: **16956**

4 / 5

Document type: **Product card** | Document date: **2019-07-16** | Generated by: **Online catalogue**

Get In Touch

 Call: [0845 6880112](tel:08456880112)
 Email: info@adremit.co.uk

Our Address

Puravent, Adremit Limited, Unit 5a, Commercial Yard,
Settle, North Yorkshire, BD24 9RH

Accessories

Electric accessories

[RT 0-30 Room Thermostat \(5151\)](#)
[CO2RT-R-D Transmitter \(6993\)](#)
[Presence detector/IR24-P \(6995\)](#)
[MTV-1/010 Controller 0..10V+ \(30650\)](#)
[DMD-C Pressure controller \(15793\)](#)
[MTP 10, 10K, Speed control \(32731\)](#)
[EC-Vent Room Unit \(3018\)](#)
[EC-Vent control board \(3115\)](#)
[REV-3POL/03 ON/OFF \(33978\)](#)
[MTP 20, on/off, 3-step \(310220\)](#)
[EC-Basic-H humidity \(24807\)](#)
[EC-Basic-T temperature \(24805\)](#)
[EC-Basic-U universal 0-10V \(24806\)](#)
[EC-Basic-CO2 and temperature \(24808\)](#)
[EC-Selector \(9908\)](#)
[CXE/AVC Modbus \(37256\)](#)

Accessories

[CB 125-0,6 230V/1 Duct heater \(5289\)](#)
[CB 125-1,2 230V/1 Duct heater \(5290\)](#)
[CB 125-1,8 230V/1 Duct heater \(5377\)](#)
[CBM 125-1,2 230V/1 Duct heater \(5480\)](#)
[VBF 125 Water heating battery \(1730\)](#)
[CWX 125-3-2,5 Duct cooler,circ \(30021\)](#)
[VBC 125-2 Water heating batt \(5457\)](#)
[LDC 125-600 Silencer \(5190\)](#)
[LDC 125-900 Silencer \(5191\)](#)
[FFR 125 Filter cassette \(1768\)](#)
[FGR 125 Filter cassette \(1804\)](#)
[FK 125 Fast clamp \(1608\)](#)
[VKK-125 Back draft damper \(1624\)](#)
[IGK-125 Wall Grid \(1631\)](#)
[RSK-125 Back draft damper \(5598\)](#)
[SG 125 Protection guard \(5607\)](#)
[VBC 125-3 Water heating batt \(9839\)](#)
[LDC 125-300 Silencer \(53722\)](#)

Documentation

 [202341_Fans_Instructions_CE_A010.pdf \(1,83MB\)](#)

 [EC-fans_Operation_and_maintenance_instr_206268_CE_\(A022\).pdf \(2,88MB\)](#)

Specification text

Name: **K 125 EC SILEO** | Item no.: **16956**

Document type: **Product card** | Document date: **2019-07-16** | Generated by: **Online catalogue**

5 / 5

Get In Touch



Call: [0845 6880112](tel:08456880112)



Email: info@adremit.co.uk

Our Address

Puravent, Adremit Limited, Unit 5a, Commercial Yard,
Settle, North Yorkshire, BD24 9RH