



# KVK SLIM 355 EC

Item no. 92155

Document type: **Product card**  
 Document date: **2019-07-10**  
 Generated by: **Systemair Online Catalogue**



## Description

- Slim design, easy to install
- Easy maintenance, service cover
- Low sound level, insulated cover
- High efficiency and low SFP in a real working point
- Potentiometer included, possible to speed control 0-100%
- Simple to install, mounting brackets included
- Integrated motor protection
- Aluzinc casing, C4 corrosion class

KVK Slim is a box fan with circular duct connections. The lid is insulated to keep a low sound level. The fan can be installed in any position. The casing is manufactured from Aluzinc in corrosion class C4.

KVK Slim EC is delivered with integrated motor protection and pre-wired potentiometer (0-10V) that allows you to easily find the desired working point. The fan can be demand controlled via sensors for CO2, temperature, humidity, presence indication and VAV. Size 315-500 also offers possibility to communication via Modbus.

The FK mounting clamp (accessory) facilitates easy installation and removal and prevents the transfer of vibration to the duct.



## Technical parameters

Nominal data		
Voltage	230	V
Frequency	50/60	Hz
Phase	1	~
Input power (P1)	536	W
Current	2,37	A
Max. airflow	1,03	m³/s
R.p.m.	1887	r.p.m.
Weight	34,3	kg
Temperature data		
Max. temperature of transported air	60	°C
Max. temperature of transported air when speed-controlled	60	°C
Sound data		
Sound pressure level at 3 m	58,7	dB(A)
Protection / Classification		
Insulation class	F	
Enclosure class, motor	IP55	

### Get In Touch

Call: [0845 6880112](tel:08456880112)  
 Email: [info@adremit.co.uk](mailto:info@adremit.co.uk)

### Our Address

Puravent, Adremit Limited, Unit 5a, Commercial Yard,  
 Settle, North Yorkshire, BD24 9RH



## Diagrams

### Diagrams

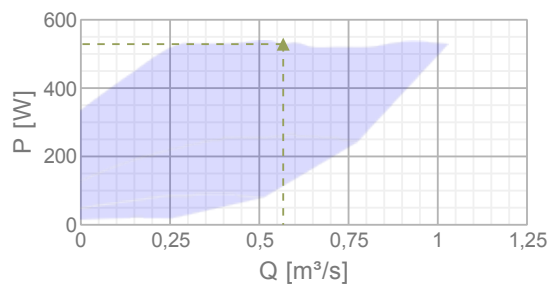
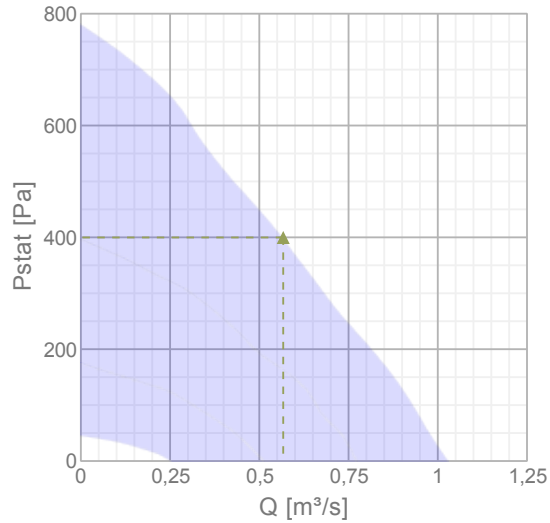

### Max efficiency

Hydraulic data										
▲ Working air flow										0,567 m <sup>3</sup> /s
▲ Working static pressure										400 Pa
▲ Power										529 W
Speed										1851 r.p.m.
Current										2,31 A
SFP										0,932 W/(l/s)
Voltage										230 V
Sound power level		63	125	250	500	1k	2k	4k	8k	Tot
Inlet	dB(A)	57	72	75	68	64	62	58	52	78
Outlet	dB(A)	55	69	71	65	66	62	59	50	75
Surrounding	dB(A)	44	57	64	57	53	48	49	40	66

### Get In Touch

Call: [0845 6880112](tel:08456880112)Email: [info@adremit.co.uk](mailto:info@adremit.co.uk)

### Our Address

Puravent, Adremit Limited, Unit 5a, Commercial Yard, Settle, North Yorkshire, BD24 9RH

## Dimensions

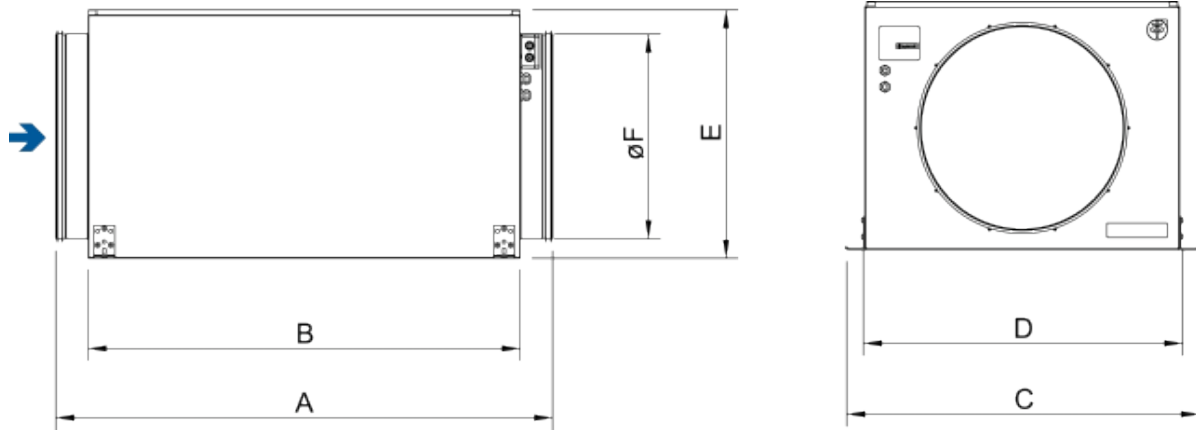

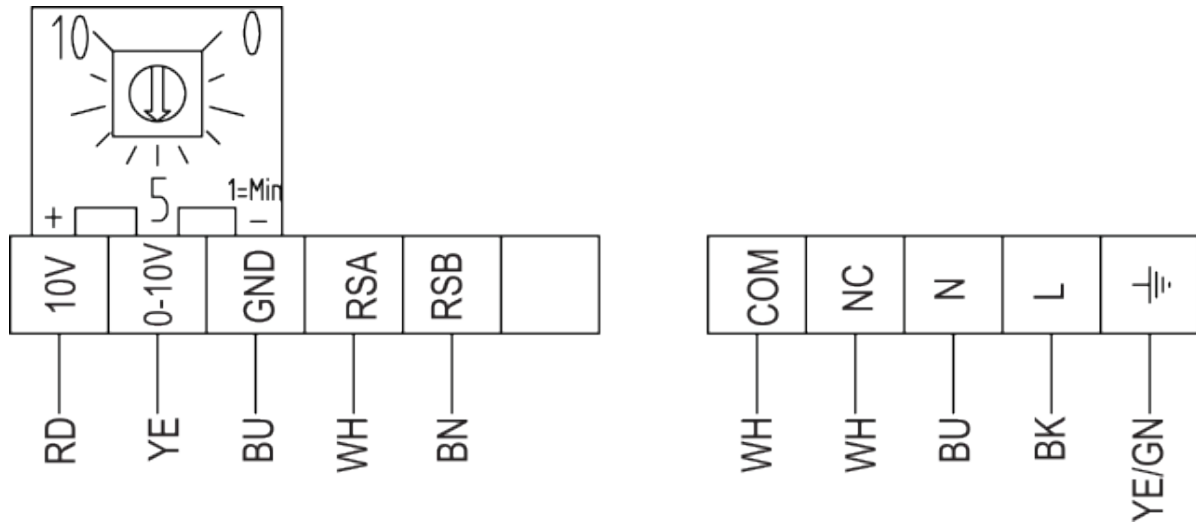

KVK SLIM	A	B	C	D	E	øF
355 EC	976	842	770	666	459	355

## Wiring



RD	Red
YE	Yellow
BU	Blue
WH	White
GN	Green
BN	Brown
BK	Black

### Get In Touch

 Call: [0845 6880112](tel:08456880112)  
 Email: [info@adremit.co.uk](mailto:info@adremit.co.uk)

### Our Address

Puravent, Adremit Limited, Unit 5a, Commercial Yard,  
Settle, North Yorkshire, BD24 9RH

## Accessories

### Electric accessories

[RT 0-30 Room Thermostat \(5151\)](#)  
[CO2RT-R-D Transmitter \(6993\)](#)  
[Presence detector/IR24-P \(6995\)](#)  
[MTV-1/010 Controller 0..10V+ \(30650\)](#)  
[DMD-C Pressure controller \(15793\)](#)  
[MTP 10, 10K, Speed control \(32731\)](#)  
[EC-Vent Room Unit \(3018\)](#)  
[EC-Vent control board \(3115\)](#)  
[REV-3POL/03 ON/OFF \(33978\)](#)  
[MTP 20, on/off, 3-step \(310220\)](#)  
[EC-Basic-H humidity \(24807\)](#)  
[EC-Basic-T temperature \(24805\)](#)  
[EC-Basic-U universal 0-10V \(24806\)](#)  
[EC-Basic-CO2 and temperature \(24808\)](#)  
[EC-Selector \(9908\)](#)  
[CXE/AVC Modbus \(37256\)](#)  
[S-5EC/FRQ \(76738\)](#)  
[PCA 1000D2 Pressure controller \(76739\)](#)

### Accessories

[CB 355-9,0 400V/3 Duct heater \(5389\)](#)  
[CB 355-12,0 400V/3 Duct heater \(5390\)](#)  
[CBM 355-9,0 400V/3 Duct heater \(5486\)](#)  
[LDC 355-900 Silencer \(5399\)](#)  
[FFR 355 Filter cassette \(1782\)](#)  
[FGR 355 Filter cassette \(1821\)](#)  
[FK 355 Fast clamp \(1614\)](#)  
[SG 355 Protection guard \(5612\)](#)  
[VK-35 Louvre shutter \(5642\)](#)  
[RSK-355 Back draft dmp. \(9972\)](#)  
[CB 355-6,0 400V/2 Duct heater \(5388\)](#)

## Documentation

 [KVK\\_Silent\\_Slim\\_Operating\\_maintenance\\_145899\\_CE\\_EN\\_A007.pdf \(1,47MB\)](#)

 [MODBUS LITE V5.01 parameter specification.pdf \(726,08kB\)](#)

### Get In Touch



Call: [0845 6880112](tel:08456880112)



Email: [info@adremit.co.uk](mailto:info@adremit.co.uk)

### Our Address

Puravent, Adremit Limited, Unit 5a, Commercial Yard,  
Settle, North Yorkshire, BD24 9RH