



KVK DUO 125 CIRCULAR DUCT FAN

Item no. 5341

Version: 50 Hz

Document type: **Product card**
 Document date: **2019-07-10**
 Generated by: **Systemair Online Catalogue**



Description

- Speed-controllable
- Integral thermal contacts
- Low noise level
- Twin fan

KVK DUO models have double inlet centrifugal fans with forward-curved impellers and maintenance-free external rotor motors. To protect the motors from overheating the fans have integral thermal contacts with leads for connection to a motor protection device.

The fans are easy to connect to spiral ducts using FK mounting clamps.

The KVK DUO models are manufactured from galvanised sheet steel and are thermally and acoustically insulated with a 50 mm layer of mineral wool. Internal surfaces are protected with perforated galvanised sheet steel.



Technical parameters

Nominal data		
Voltage	230	V
Frequency	50	Hz
Phase	1	~
Input power (P1)	41,4	W
Current	0,171	A
Max. airflow	0,0528	m³/s
R.p.m.	1724	r.p.m.
Capacitor	1,5	µF
Weight	17,8	kg
Temperature data		
Max. temperature of transported air	64,9	°C
Max. temperature of transported air when speed-controlled	64,9	°C
Sound data		
Sound pressure level at 3 m	28,7	dB(A)

Get In Touch

Call: [0845 6880112](tel:08456880112)
 Email: info@adremit.co.uk

Our Address

Puravent, Adremit Limited, Unit 5a, Commercial Yard,
 Settle, North Yorkshire, BD24 9RH







Protection / Classification	
Insulation class	B
Enclosure class, motor	IP44
ErP	
Energy class, basic unit	E
Energy class, basic unit option	C
ErP ready	ErP 2016/ErP 2018

Energy class label

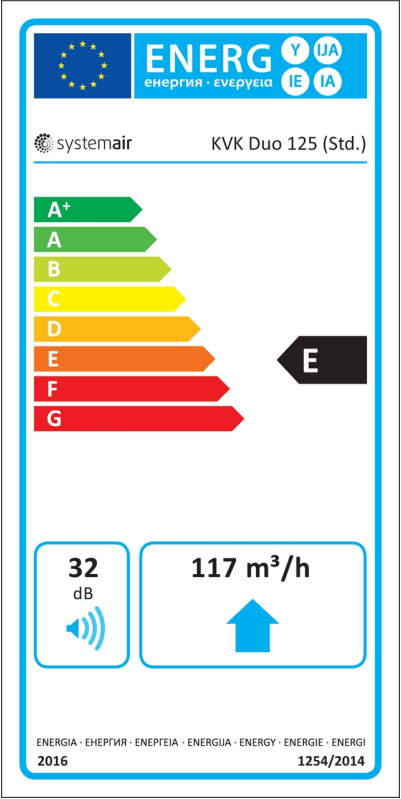
Energy class, basic unit



Get In Touch

 **Call:** [0845 6880112](tel:08456880112)
 **Email:** info@adremit.co.uk

Our Address

Puravent, Adremit Limited, Unit 5a, Commercial Yard,
Settle, North Yorkshire, BD24 9RH



Energy class, unit with local demand control

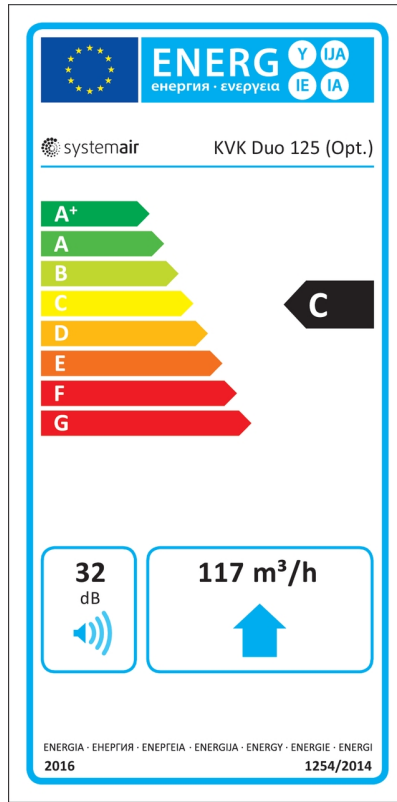

Diagrams

Diagrams

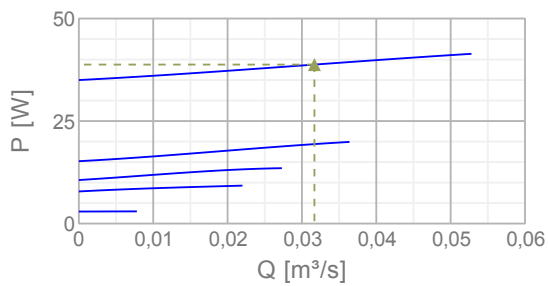
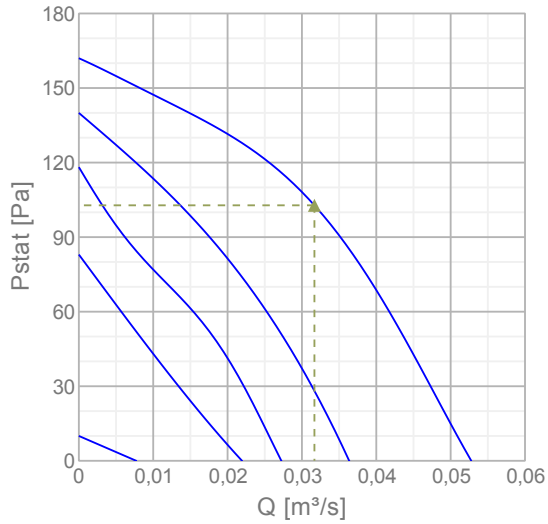

Name: **KVK DUO 125 CIRCULAR DUCT FAN** | Item no.: **5341** | Version: **50 Hz**

Document type: **Product card** | Document date: **2019-07-10** | Generated by: **Online catalogue**

Get In Touch

Call: [0845 6880112](tel:08456880112)
 Email: info@adremit.co.uk

Our Address

Puravent, Adremit Limited, Unit 5a, Commercial Yard,
 Settle, North Yorkshire, BD24 9RH

Max efficiency

Hydraulic data										
▲ Working air flow										0,0317 m ³ /s
▲ Working static pressure										103 Pa
▲ Power										38,8 W
Speed										2101 r.p.m.
Current										0,163 A
SFP										1,22 W/(l/s)
Voltage										230 V
Sound power level		63	125	250	500	1k	2k	4k	8k	Tot
Inlet	dB(A)	47	48	41	40	38	33	27	24	52
Outlet	dB(A)	51	54	54	54	53	53	47	40	61
Surrounding	dB(A)	28	32	25	25	26	17	20	19	35

Dimensions

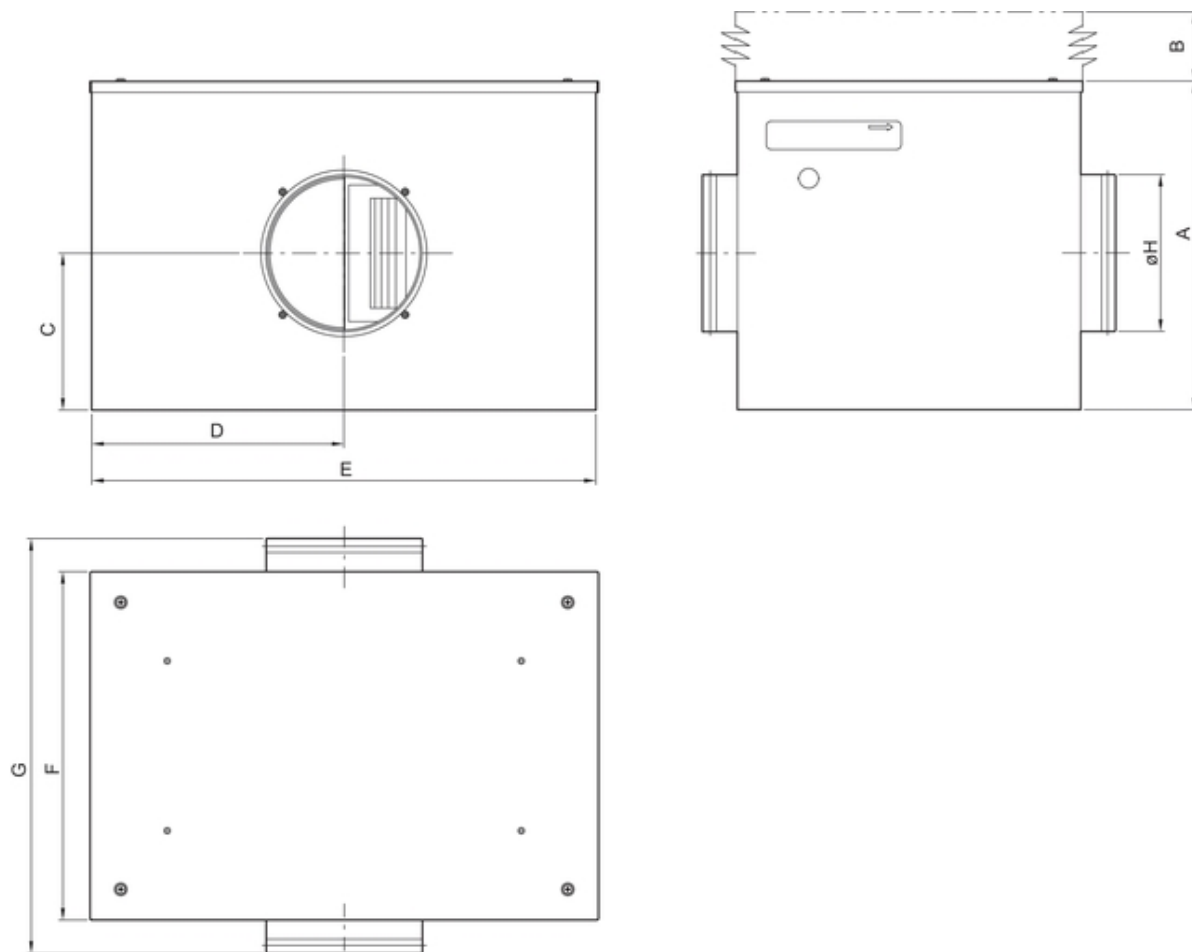

KVK DUO	A	B	C	D	E	F	G	øH
125	333	275	165	255	510	350	425	125
160	333	275	165	255	510	350	425	160
200	386	325	190	300	600	400	475	200
250	460	400	207	360	720	500	615	250

Name: **KVK DUO 125 CIRCULAR DUCT FAN** | Item no.: **5341** | Version: **50 Hz**

Document type: **Product card** | Document date: **2019-07-10** | Generated by: **Online catalogue**

4 / 6

Get In Touch

Call: [0845 6880112](tel:08456880112)
 Email: info@adremit.co.uk

Our Address

Puravent, Adremit Limited, Unit 5a, Commercial Yard,
 Settle, North Yorkshire, BD24 9RH

230V 1~

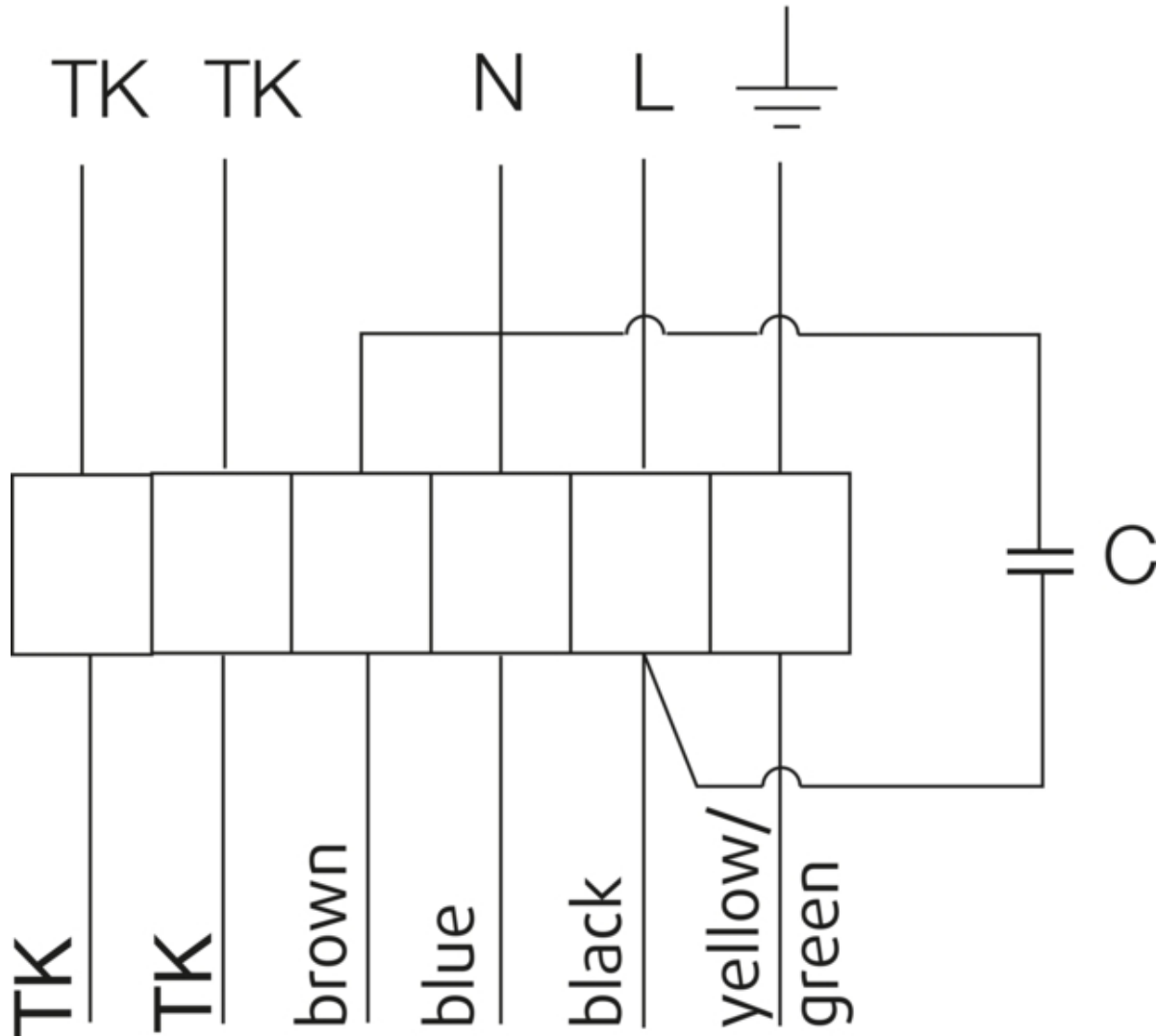

U1 = blue = blau
 U2 = black = schwarz
 Z = brown = braun
 PE = yellow/green = grün-gelb

Accessories

Electric accessories

- [REU 1.5 Speed control \(5004\)](#)
- [RTRE 1.5 Speed control \(5008\)](#)
- [REE 1 Speed control \(5314\)](#)
- [AWE-SK Motorprotection 2A/230V \(5138\)](#)
- [ACO8A Auto Changeover panel \(84291\)](#)
- [STL 1.5 Speed controller \(84251\)](#)

Get In Touch

 **Call:** [0845 6880112](tel:08456880112)
 **Email:** info@adremit.co.uk

Our Address

Puravent, Adremit Limited, Unit 5a, Commercial Yard,
 Settle, North Yorkshire, BD24 9RH

Accessories

[CB 125-0.6 230V/1 Duct heater \(5289\)](#)
[CB 125-1.2 230V/1 Duct heater \(5290\)](#)
[CB 125-1.8 230V/1 Duct heater \(5377\)](#)
[CBM 125-1.2 230V/1 Duct heater \(5480\)](#)
[VBF 125 Water heating battery \(1730\)](#)
[CWX 125-3-2.5 Duct cooler,circ \(30021\)](#)
[VBC 125-2 Water heating batt \(5457\)](#)
[LDC 125-600 Silencer \(5190\)](#)
[LDC 125-900 Silencer \(5191\)](#)
[FFR 125 Filter cassette \(1768\)](#)
[FGR 125 Filter cassette \(1804\)](#)
[FK 125 Fast clamp \(1608\)](#)
[VKK-125 Back draft damper \(1624\)](#)
[IGK-125 Wall Grid \(1631\)](#)
[RSK-125 Back draft damper \(5598\)](#)
[SG 125 Protection guard \(5607\)](#)
[LDC 125-300 Silencer \(53722\)](#)

Documentation



202341_Fans_Instructions_CE_A010.pdf (1,83MB)

Specification text

Get In Touch



Call: [0845 6880112](tel:08456880112)



Email: info@adremit.co.uk

Our Address

Puravent, Adremit Limited, Unit 5a, Commercial Yard,
Settle, North Yorkshire, BD24 9RH