



# KBT 200DV THERMO FAN

Item no. 77200

Document type: **Product card**  
 Document date: **2019-07-16**  
 Generated by: **Systemair Online Catalogue**

## Description

- Max temperature of transported air 120°C
- Speed-controllable
- Integral thermal contacts
- Low sound level
- Weather protection for the motor is standard
- Drain plug for liquids that accumulate in the casing is standard

The KBT fans have impellers manufactured from galvanised sheet steel with forward-curved blades. The casing is manufactured from double-skinned galvanised sheet steel and is insulated with 50 mm mineral wool.

The KBT fans have a swing-out door for easy inspection and service. The fan is isolated from the casing via connectors and anti-vibration dampers are incorporated into the base frame.

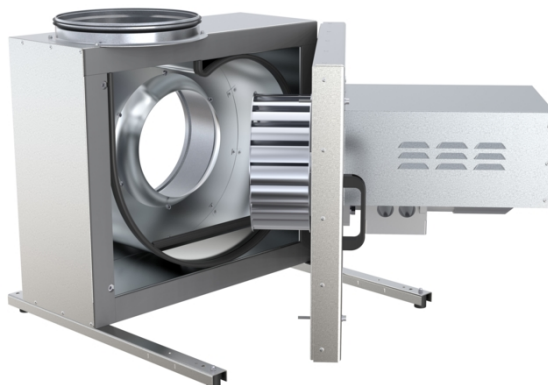

To protect the motors from overheating the KBT fans have integral thermal contacts with external leads for connection to a motor protection device.

## Technical parameters

Nominal data	
Voltage	400 V
Frequency	50 Hz
Phase	3 ~
Connection	D/Y
Input power (P1)	567 W
Current	1,76 A
Max. airflow	0,488 m³/s
R.p.m.	1453 r.p.m.
Weight	35 kg
Temperature data	
Max. temperature of transported air	120 °C
Sound data	
Sound pressure level at 4 m	37 dB(A)
Protection / Classification	
Insulation class	F
Enclosure class, motor	IP54

### Get In Touch

Call: [0845 6880112](tel:08456880112)  
 Email: [info@adremit.co.uk](mailto:info@adremit.co.uk)

### Our Address

Puravent, Adremit Limited, Unit 5a, Commercial Yard,  
 Settle, North Yorkshire, BD24 9RH



## Diagrams

### Diagrams

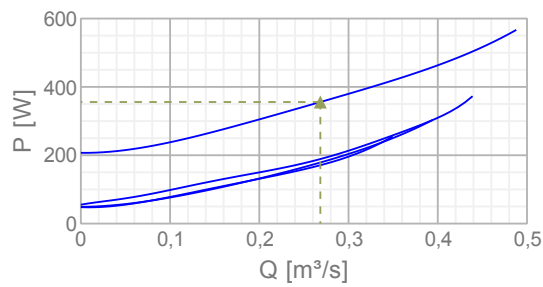
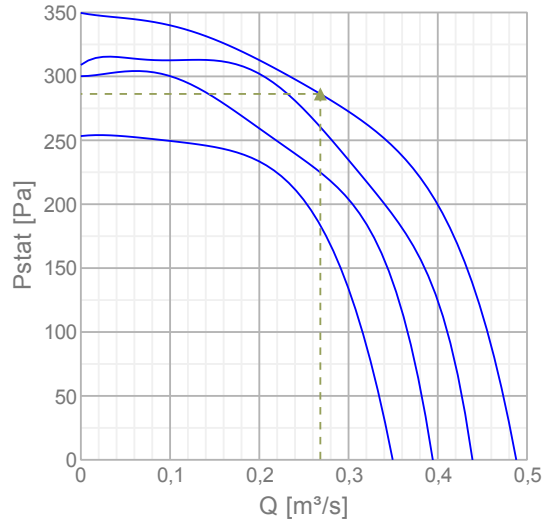

### Max efficiency

Hydraulic data	
▲ Working air flow	0,268 m³/s
▲ Working static pressure	286 Pa
▲ Power	356 W
Speed	1465 r.p.m.
Current	1,79 A
SFP	1,33 W/(l/s)
Voltage	400 V

Name: **KBT 200DV THERMO FAN** | Item no.: **77200**

Document type: **Product card** | Document date: **2019-07-16** | Generated by: **Online catalogue**

2 / 4

### Get In Touch

Call: [0845 6880112](tel:08456880112)  
 Email: [info@adremit.co.uk](mailto:info@adremit.co.uk)

### Our Address

Puravent, Adremit Limited, Unit 5a, Commercial Yard,  
 Settle, North Yorkshire, BD24 9RH

## Dimensions

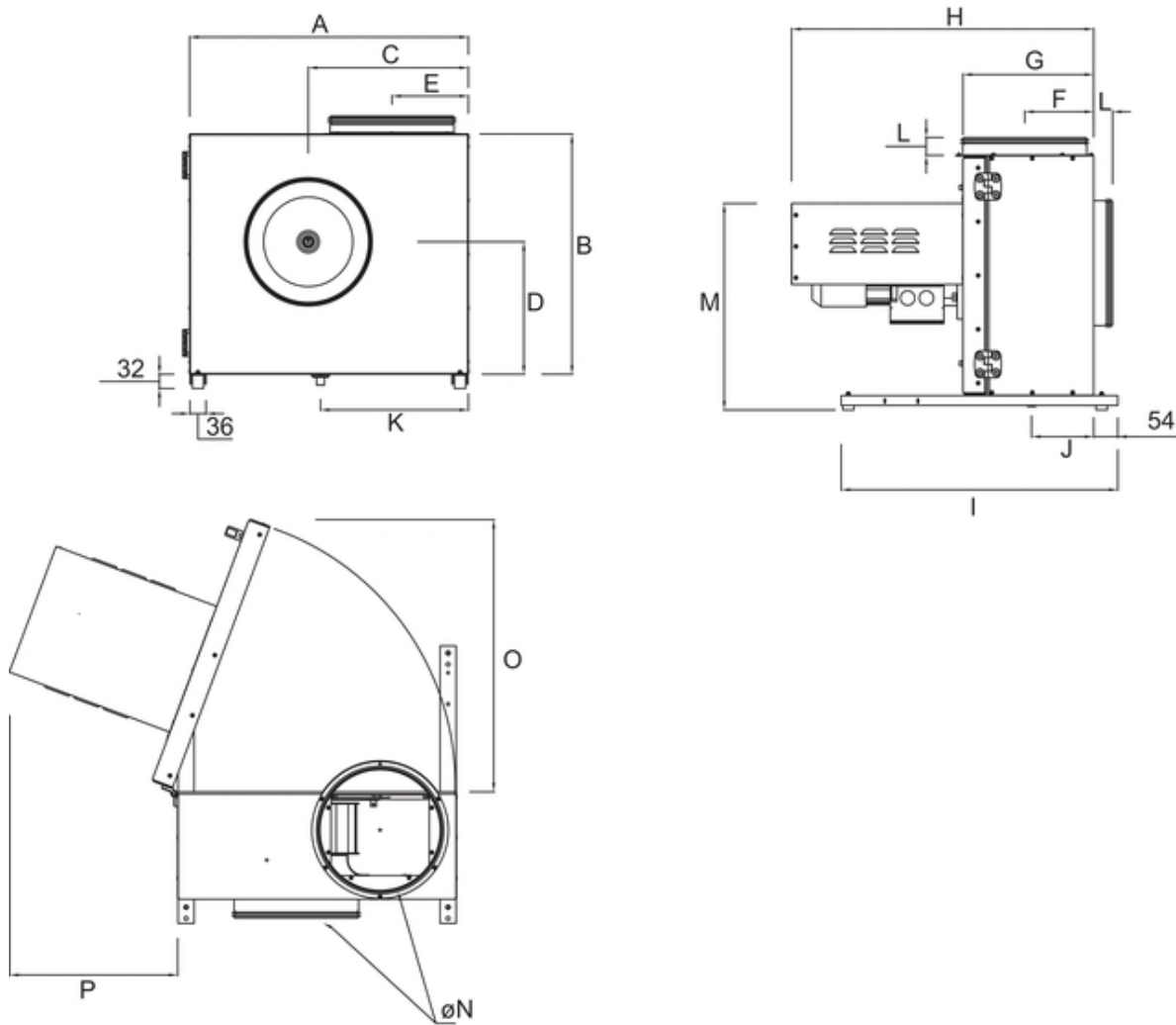

	A	B	C	D	E	F	G	H	I	J	K	L	M	N	O	P
KBT 160	437	384	249	212	128	100	209	473	470	100	227	43	345	160	437	320
KBT 180	470	412	272	224	134	105	218	483	470	95	244	43	366	180	470	320
KBT 200	510	445	293	250	143	115	233	617	470	113	273	43	392	200	510	440
KBT 225	522	455	301	256	147	121	251	635	620	121	282	43	412	225	522	440
KBT 250	576	500	333	280	161	140	272	656	620	139	305	43	436	250	576	440
KBT 280	625	537	359	296	171	155	293	677	620	139	331	43	462	280	625	440

Name: **KBT 200DV THERMO FAN** | Item no.: **77200**

Document type: **Product card** | Document date: **2019-07-16** | Generated by: **Online catalogue**

3 / 4

### Get In Touch

Call: [0845 6880112](tel:08456880112)  
 Email: [info@adremit.co.uk](mailto:info@adremit.co.uk)

### Our Address

Puravent, Adremit Limited, Unit 5a, Commercial Yard,  
 Settle, North Yorkshire, BD24 9RH

## Wiring

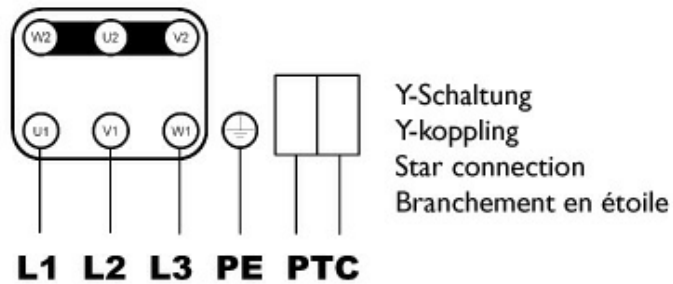
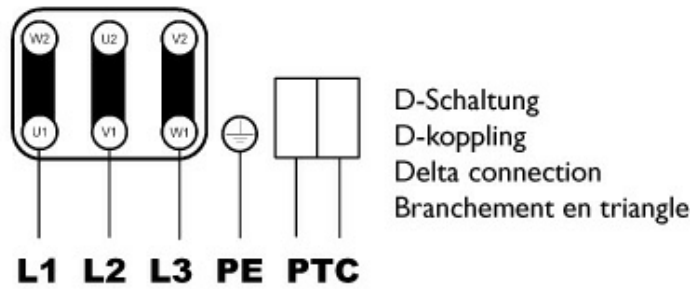

Top picture = High speed connection  
Bottom picture = Low speed connection

### Accessories

#### Electric accessories

[RTRD 2 Speed Cont. Systemair \(5941\)](#)  
[RTRDU 2 Speed contr. Systemair \(5945\)](#)  
[S-DT2SKT Two speed switch Y/D \(2697\)](#)  
[RT 0-30 Room Thermostat \(5151\)](#)  
[STDT 16 Motor Protection \(5152\)](#)  
[STDT 16E Motor Protection \(5153\)](#)  
[DTV200 \(6261\)](#)  
[REV-5POL/07 ON/OFF \(33980\)](#)  
[FRQ5S-4A+LED V2 \(36233\)](#)  
[FRQS-4A V2 \(36231\)](#)  
[DTV500A \(96807\)](#)

#### Accessories

[ASF 200/KB Flex. connection \(2714\)](#)  
[KBT 160/180/200 Wall bracket \(182814\)](#)

### Documentation

 [202341\\_Fans\\_Instructions\\_CE\\_A010.pdf \(1,83MB\)](#)

### Get In Touch

 **Call:** [0845 6880112](tel:08456880112)  
 **Email:** [info@adremit.co.uk](mailto:info@adremit.co.uk)

### Our Address

Puravent, Adremit Limited, Unit 5a, Commercial Yard,  
Settle, North Yorkshire, BD24 9RH