



# INFRA



## Gas-fired black radiant tube heater

Gas-fired black radiant tube heater with atmospheric burner and electrical ignition. Output from 10 to 100 kW.



For more information, downloads and videos, visit the Infra page on our website

### Get In Touch

 Call: [0845 6880112](tel:08456880112)  
 Email: [info@adremit.co.uk](mailto:info@adremit.co.uk)

### Our Address

Puravent, Adremit Limited, Unit 5a, Commercial Yard, Settle, North Yorkshire, BD24 9RH





#### Product features

- Available in 6 different types from 9 to 44,2 kW
- Various sizes, from 3 to 18 m length
- Highly reflective reflector hood, optional double air insulated (type +)
- The radiator with a double air-insulated reflector can be optimized energetically by using a flue gas cooler (type ++)
- The highly reflective radiation hood features integrated V-shaped reflectors and end caps
- Available in natural gas and propane
- Easy installation and maintenance
- Optional: waterproof stainless steel version for damp rooms

#### High efficiency black tube radiant heater

Mark INFRA / INFRA MONO black tube radiant heaters heat with long-wave infrared radiation. Radiant heating is based on the principle of heat transfer from a warm object to an object of lower temperature by means of electromagnetic wave energy. This electromagnetic wave, not hindered by air, radiates walls, floor and the people present in the room.

As soon as the infrared radiation gets in contact with the human body, it is converted into heat. This does not cause any change in the air temperature. This method of heat generation is considered very pleasant.

The more intense the radiant heat is, the less the actual air temperature has to be increased for a comfortable indoor climate. Therefore, heating with the Mark INFRA system is much more economical compared to conventional systems.

Possible applications include: sports halls, production facilities, aircraft hangars, showrooms and garages.

#### The benefits of radiant heating include:

- A radiation efficiency of up to 75% according to EN 416-2
- A flue efficiency higher than 90%
- No spreading of dust and low noise level during operation
- Can be used in a focused way to enable a high energy efficiency
- A uniform heat distribution across the entire length of the radiator is achieved by the use of an overpressure burner with a long stable flame, in combination with built-in turbulators in the radiant tube
- By using a 1-stage or 2-stage control the output of the radiant heater is adapted to the required heat



Remote connection possible with the PinTherm Infra Connect!

#### Get In Touch

Call: 0845 6880112  
Email: [info@adremit.co.uk](mailto:info@adremit.co.uk)

#### Our Address

Puravent, Adremit Limited, Unit 5a, Commercial Yard,  
Settle, North Yorkshire, BD24 9RH



### Dimensions

INFRA 10-3

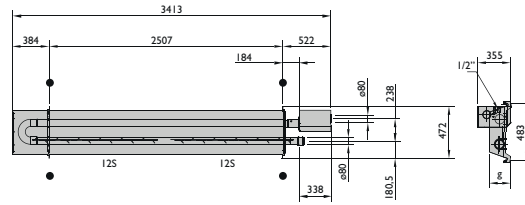

INFRA 15-5

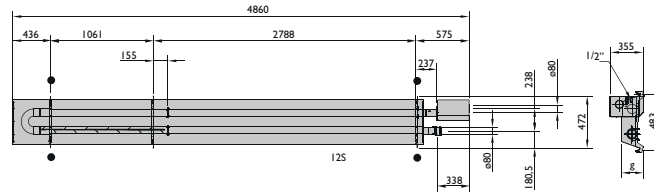

INFRA 20-6

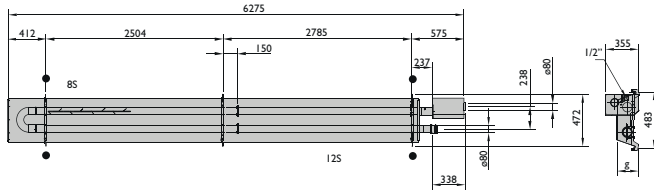

INFRA 30-6

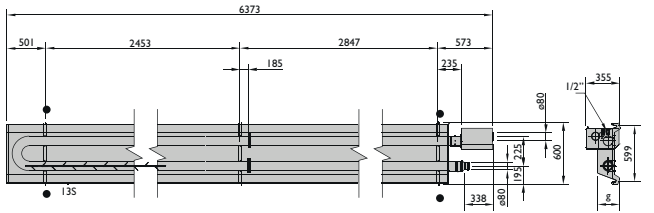

INFRA 30-9 / 40-9 / 50-9

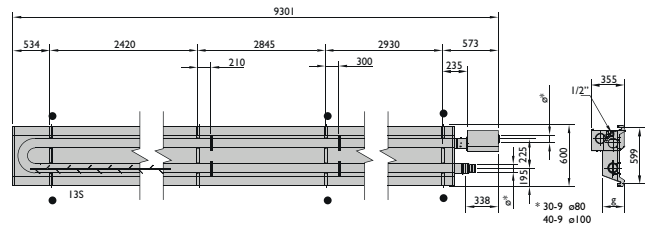

INFRA 50-12

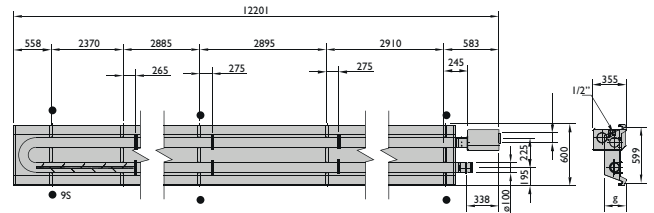

INFRA MONO 30-12

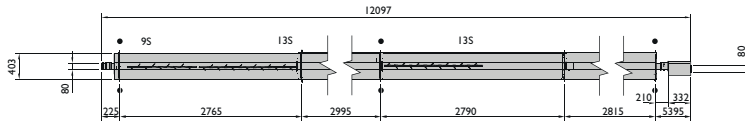

INFRA MONO 50-18

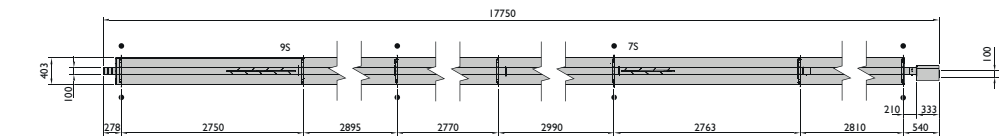

● suspension point

#### Get In Touch

Call: 0845 6880112  
Email: [info@adremit.co.uk](mailto:info@adremit.co.uk)

#### Our Address

Puravent, Adremit Limited, Unit 5a, Commercial Yard, Settle, North Yorkshire, BD24 9RH



## Technical information

Type		10-3	15-5	20-6	30-6	30-9	40-9	50-9	50-12	30-12 MONO	50-18 MONO
Nominal load (NCV)	kW	10,0	14,0	18,0	28,0	30,0	38,0	46,0	49,9	30,0	49,9
Flue efficiency (NCV)	%	91	90,7	90,6	90,0	91,7	90,5	90,0	90,3	91,7	90,3
Gas consumption G20 (15 °C)	m <sup>3</sup> /h	1,10	1,50	1,90	2,90	3,20	3,90	4,9	5,30	3,20	5,30
Gas consumption G25 (15 °C)	m <sup>3</sup> /h	1,20	1,70	2,20	3,30	3,60	4,60	5,4	5,90	3,60	5,90
Gas consumption G31 (15 °C)	kg/h	0,79	1,11	1,42	2,12	2,21	2,99	3,72	3,92	2,36	3,92
Gas consumption G30 (15 °C)	kg/h	0,81	1,14	1,46	2,19	2,27	3,08	3,64	4,04	2,43	4,04
Weight	kg	48 / 65*	66 / 91*	81 / 112*	97 / 136*	132 / 190*	132 / 190*	132	168 / 244*	101	143
Electrical power	W	55	57	60	60	60	63	63	63	60	63
Recommended suspension height, horizontal	m	4	4	4	5	5	5	7	7	5	7
Recommended suspension height, 30° angle	m	4	4	4	4	4	5	6	6	5	6
Burner pressure G25	mbar	16,0	16,0	16,0	16,0	16,0	16,0	16,0	16,0	16,0	16,0
Burner pressure G20	mbar	11,0	11,0	11,0	11,5	11,5	11,5	11,5	11,5	12,0	12,0
Burner pressure G31	mbar	35,1	35,1	35,1	35,1	35,1	35,1	35,1	35,1	35,1	35,1
Burner pressure G30	mbar	27,2	27,2	27,2	27,2	27,2	27,2	27,2	27,2	27,2	27,2
Sound level at 5 metres	dB(A)	41	41	42	42	42	43	43	43	42	43

\* Single-/ Double-walled reflector

## Accessories – flue gas exhaust

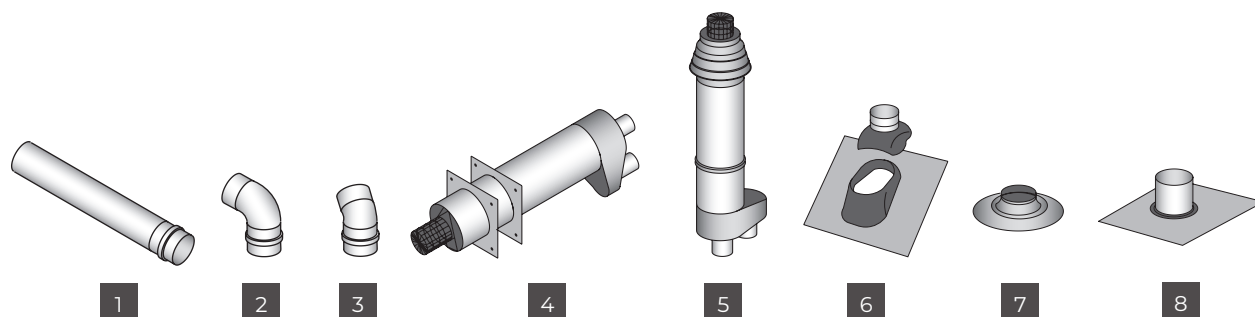

- 1 Extension set
- 2 90° elbow
- 3 45° elbow
- 4 Single flue set horizontal
- 5 Single flue set vertical
- 6 Roof flashing for pitched roof
- 7 Adhesive plate
- 8 Flexible roof flashing for cladded roof

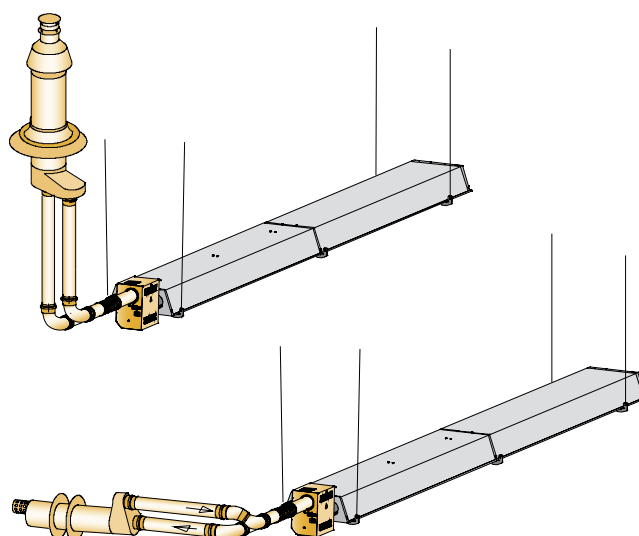

### Get In Touch

Call: [0845 6880112](tel:08456880112)  
Email: [info@adremit.co.uk](mailto:info@adremit.co.uk)

### Our Address

Puravent, Adremit Limited, Unit 5a, Commercial Yard,  
Settle, North Yorkshire, BD24 9RH



### Controls

max. 10 units

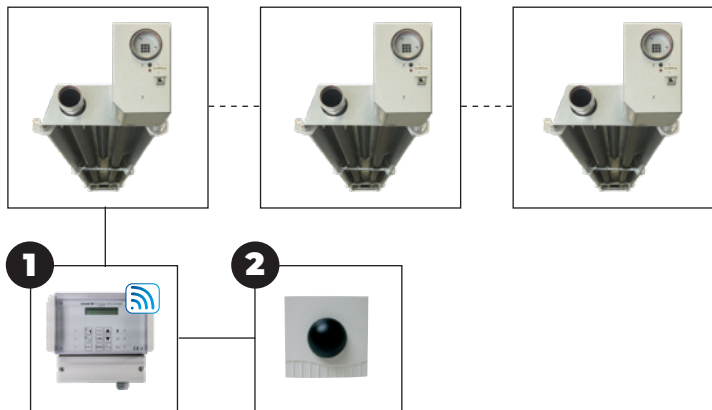

#### Control combination options

Infra + **1** + **2**

See price list for description and code numbers of the relevant items

### Zone control

Zone 1

Zone 2

Zone 3

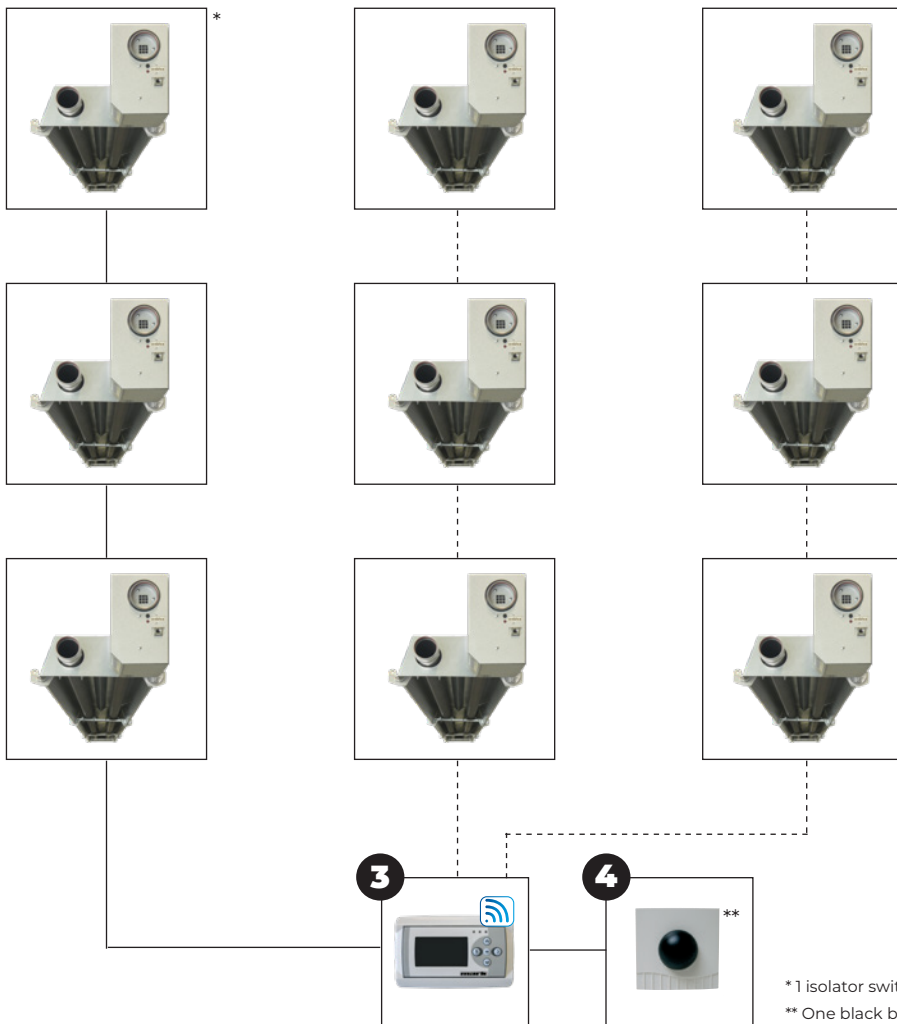

#### Control combination options zones Infra

2 zones + **3** + **4** + **4**

3 zones + **3** + **4** + **4** + **4**

See price list for description and code numbers of the relevant items

\*1 isolator switch per Infra

\*\* One black bulb sensor per zone

#### Get In Touch

Call: 0845 6880112  
Email: [info@adremit.co.uk](mailto:info@adremit.co.uk)

#### Our Address

Puravent, Adremit Limited, Unit 5a, Commercial Yard, Settle, North Yorkshire, BD24 9RH