

FRQ5S-E-6/10A

Frequency inverter with sine filter for 1 ~ fans

Operating Instructions



Speed controller with 5-step switch for presetting the fan speed

Keep for reference!

Software version: D1628A from Version 11.03

L-BAL-E247-GB 1512 Index 001

Part.-No. 00163444-42

 **systemair**

Get In Touch

 **Call:** [0845 6880112](tel:08456880112)
 **Email:** info@adremit.co.uk

Our Address

Puravent, Adremit Limited, Unit 5a, Commercial Yard,
Settle, North Yorkshire, BD24 9RH

Content

1	General notes	4
1.1	Structure of the operating instructions	4
1.2	Target group	4
1.3	Exclusion of liability	4
1.4	Copyright	4
2	Safety instructions	4
2.1	Intended use	4
2.2	Explanations of symbols	4
2.3	Product safety	5
2.4	Requirements placed on the personnel / due diligence	5
2.5	Start-up and during operation	5
2.6	Working on device / Hazards through “residual voltage”	5
2.7	Modifications / interventions in the device	6
2.8	Operator’s obligation of diligence	6
2.9	Employment of external personnel	6
3	Product overview	7
3.1	Operational area	7
3.2	Functional description	7
3.3	Maintenance	7
3.4	Transport	7
3.5	Storage	7
3.6	Disposal / recycling	8
4	Mounting	8
4.1	General notes	8
4.2	Minimum space requirement	8
4.3	Outdoor installation	8
4.4	Installation location for agriculture	9
4.5	Temperature influences during commissioning	9
5	Electrical installation	9
5.1	Safety precautions	9
5.2	EMC-compatible installation	9
5.2.1	Motor cable	9
5.2.2	Control cables	9
5.3	Mains connection	9
5.3.1	Line voltage	9
5.3.2	Required quality attributes for the mains voltage	10
5.3.3	Leakage current, securely attached, protective earth conductor	10
5.4	Residual-current-operated protective device	10
5.5	Inverter output	10
5.5.1	Motor connection	10
5.5.2	Disconnection between controller and motor (repair switch)	10
5.5.3	U/f-characteristic curve	10
5.6	Motor protection	11
5.7	Enable, Device ON / OFF (Digital In 1 = D1)	12
5.8	Relay outputs (K2)	12
5.9	Bypass circuit	12
5.10	Potential at control voltage connections	12
6	Start-up	12
6.1	Prerequisites for commissioning	12

Get In Touch

 Call: [0845 6880112](tel:08456880112)
 Email: info@adremit.co.uk

Our Address

Puravent, Adremit Limited, Unit 5a, Commercial Yard,
 Settle, North Yorkshire, BD24 9RH



7	Diagnostics / Faults	13
8	Enclosure	14
8.1	Technical data	14
8.1.1	Max. load dependent on ambient temperature and line voltage.	15
8.2	Connection diagram	16
8.3	Dimensions [mm]	16
8.4	Manufacturer reference	17

Get In Touch

 **Call:** [0845 6880112](tel:08456880112)
 **Email:** info@adremit.co.uk

Our Address

Puravent, Adremit Limited, Unit 5a, Commercial Yard,
Settle, North Yorkshire, BD24 9RH

1 General notes

1.1 Structure of the operating instructions

Before installation and start-up, read this manual carefully to ensure correct use! We emphasize that these operating instructions apply to specific units only, and are in no way valid for the complete system!

Use these operating instructions to work safely with and on the device. They contain safety instructions that must be complied with as well as information that is required for failure-free operation of the device.

Keep these operating instructions together with the device. It must be ensured that all persons that are to work on the device can refer to the operating instructions at any time.

Keep the operating instructions for continued use. They must be passed-on to all successive owners, users and final customers.

1.2 Target group

The operating instructions address persons entrusted with planning, installation, commissioning and maintenance and servicing and who have the corresponding qualifications and skills for their job.

1.3 Exclusion of liability

Concurrence between the contents of these operating instructions and the described hardware and software in the device has been examined. It is still possible that non-compliances exist; no guarantee is assumed for complete conformity. To allow for future developments, construction methods and technical data given are subject to alteration. We do not accept any liability for possible errors or omissions in the information contained in data, illustrations or drawings provided.

We accept no liability for damage caused by misuse, incorrect use, improper use or as a consequence of unauthorized repairs or modifications.

1.4 Copyright

These operating instructions contain copyright protected information. The operating instructions may be neither completely nor partially photocopied, reproduced, translated or put on data medium without previous explicit consent. Infringements are liable for damages. All rights reserved, including those that arise through patent issue or registration on a utility model.

2 Safety instructions

This chapter contains instructions to prevent personal injury and property damage. These instructions do not lay claim to completeness. In case of questions and problems, please consult our company technicians.

2.1 Intended use

The equipment is to be used solely for the purposes specified and confirmed in the order. Other uses which do not coincide with, or which exceed those specified will be deemed unauthorised unless contractually agreed. Damages resulting from such unauthorised uses will not be the liability of the manufacturer. The user will assume sole liability.

Reading these operating instructions and complying with all contained instructions - especially the safety notifications contained therein - are considered part of intended use. To consider is also the manual of attached components. Not the manufacturer, rather the operator of the device is liable for any personal harm or material damage arising from non-intended use!

2.2 Explanations of symbols

Safety instructions are highlighted with warning triangles and are depicted according to the degree of hazard as follows.



Attention!



General hazardous area. Death or severe injury or significant property damage can occur if the corresponding precautions are not taken!

Get In Touch

Call: 0845 6880112
 Email: info@adremit.co.uk

Our Address

Puravent, Adremit Limited, Unit 5a, Commercial Yard,
Settle, North Yorkshire, BD24 9RH

	<p>Danger due to electric current Danger by dangerous, electric voltage! Death or severe injury can occur if the corresponding precautions are not taken!</p>
	<p>Information Important additional information and advice for user.</p>

2.3 Product safety

The device conforms to the state of the art at the time of delivery and is fundamentally considered to be reliable. The device and its accessories must only be used in a flawless condition and installed and operated in compliance with the assembly instructions and/or operating instructions. Operating outside the device's technical specifications (☞ name plate and attachment / technical data) can lead to a defect in the device and additional damage!

In the case of a malfunction or a failure of the equipment check all functions with alarms in order to prevent injury to persons or property. Note possibility of back-up operation. If used in intensive animal environments, any malfunctions in the air supply must be detected as soon as possible to prevent the development of a life-threatening situation for the animals. The design and installation of the system must comply with local regulations and directives. In Germany these include DIN VDE 0100, the animal protection and the keeping of working animals ordinance and the pig-keeping ordinance etc. Also note the instructions of AEL, DLG, VdS.

2.4 Requirements placed on the personnel / due diligence

Persons entrusted with the planning, installation, commissioning and maintenance and servicing in connection with the frequency inverter must have the corresponding qualifications and skills for these jobs.

In addition, they must be knowledgeable about the safety regulations, EU directives, rules for the prevention of accidents and the corresponding national as well as regional and in-house regulations. Personnel to be trained or instructed and apprentices are only permitted to work on the device under the supervision of an experienced person. This also applies to personnel undergoing general training. Comply with the legal minimum age.

This device is not intended to be used by people (including children) who have restricted mental, sensory or intellectual abilities or who have a lack of experience and/or knowledge.

2.5 Start-up and during operation



Attention!

- During commissioning, unexpected and hazardous conditions can arise in the entire installation due to defective adjustments, defective components or incorrect electrical connections. Remove all persons and objects from the hazardous area.
- During operation, the device must be closed or installed in a control cabinet. Fuses may only be replaced by new ones and must not be repaired or bypassed. The data for the maximum line fuse are to be considered absolutely (☞ Technical data). Use only fuses specified in schematic diagrams.
- Any faults detected in the electric system/modules/operating equipment must be corrected immediately. If these faults are not corrected, the device/system is potentially very dangerous. The device/system must therefore not be operated when it is faulty.
- Pay attention to smooth, low vibration running of the motor/fan, the appropriate instructions in the drive documentation must be observed!

2.6 Working on device / Hazards through “residual voltage”



Information

Mounting, electrical connection, and start-up operation may only be carried out by an electrical specialist in accordance with electrotechnical regulations (e.g. EN 50110 or EN 60204)!

Get In Touch

☎ Call: 0845 6880112
 ✉ Email: info@adremit.co.uk

Our Address

Puravent, Adremit Limited, Unit 5a, Commercial Yard,
 Settle, North Yorkshire, BD24 9RH



Danger due to electric current

- It is generally forbidden to carry out work on electrical live parts. Protection class of the device when open is IP00! It is possible to touch hazardous voltages directly.
- The safe isolation from the supply must be checked using a **two-pole** voltage detector.
- Even after disconnecting the mains voltage, life-threatening charges can appear between the protective ground “PE” and the mains connection.
- The protective earth is conducting high discharge currents (dependent on the switching frequency, current-source voltage and motor capacity). Earthing in compliance with EN specifications shall therefore be observed even for testing and trial conditions (EN 50 178, Art. 5.2.11). Without earthing, dangerous voltages can be present on the motor housing.

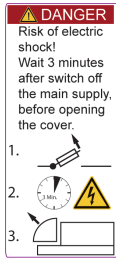

Waiting period at least 3 minutes!

Through use of capacitors, danger of death exists even after switching off the device through directly touching the energized parts or due to parts that have become energized due to faults.

It is only permitted to remove the housing cover after waiting for 3 minutes once the line supply cable has been shut down. Should measurement or adjustment work be unavoidable on the opened unit while still powered, then this may only be performed by qualified personnel acquainted with the thereby associated hazards.



Attention!

Automatically restart after a power failure or mains disconnection!

2.7 Modifications / interventions in the device



Attention!

For reasons of safety, no unauthorized interventions or modifications may be made on the device. All planned modifications must be authorized by the manufacturer in writing.

Only use the manufacturer's original spare parts / wearing parts / accessories. These parts are specially designed for this device. If parts from other sources are used, there is no guarantee that they are designed and produced for the proper loads and with the required level of safety. Parts and special equipment not supplied by the manufacturer are not approved for use.

2.8 Operator's obligation of diligence

- The contractor or owner must also ensure that the electric systems and equipment are operated and maintained in accordance with electro-technical regulations.
- The owner is obliged to ensure that the device is operated in perfect working order only.
- The device may only be used as intended (☞ “Application”).
- You must periodically examine the safety equipment for their properly functioning condition.
- The assembly instructions and/or operating instructions are always readily available at the location where the device is being used, are complete and are in legible condition.
- These persons are regularly instructed in all applicable questions regarding occupational safety and environmental protection and are knowledgeable regarding the assembly instructions and/or operating instructions and, especially, are familiar with the safety instructions contained therein.
- All safety and warning notices attached to the device are never removed and remain legible.

2.9 Employment of external personnel

Maintenance and service work are frequently carried out by external employees who often do not recognize the specific situations and the thus resulting dangers. These persons must be comprehensively informed about the hazards in their area of activity.

You must monitor their working methods in order to intervene in good time if necessary.

Get In Touch

Call: 0845 6880112
Email: info@adremit.co.uk

Our Address

Puravent, Adremit Limited, Unit 5a, Commercial Yard,
Settle, North Yorkshire, BD24 9RH

3 Product overview

3.1 Operational area

Frequency inverter designed for a stepless control of fans without additional (electromagnetic) motor noise.

By using the integrated all-pole effective Sine filter (phase to phase and phase to ground), an absolute parallel control of fans without risk of damage for motors is possible. Screened motor cables are not required!

Only suitable for drives with low set-off torque (e.g.: fans or pumps).

3.2 Functional description

Frequency inverters of these series generate their 3 ~ output with variable voltage and frequency from the 1 ~ AC mains network on the input.

The devices are constructed in accordance with the general requirement in EN 61800-2 for adjustable speed electrical power systems and is intended for one-quadrant drives.

The PFC (Power Factor Controller) makes the output voltage mostly independent of the mains voltage.

The fan speed is preset with the 5-step switch.

Step	Output frequency *
0	0 Hz
1	10 Hz
2	20 Hz
3	30 Hz
4	40 Hz
5	50 Hz

Direct switching from step "0" to step "5" or from step "5" to step "0" is not possible!

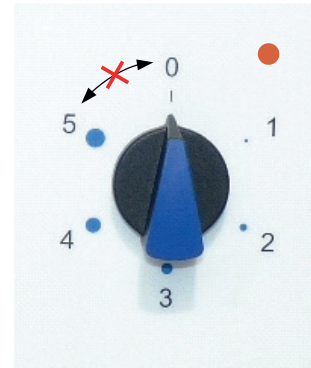

23.05.2013
v_5_step_cont7_basic_sa.vsd

* The output frequency can be adapted by an internal potentiometer if necessary (☞ inverter output: U/f-characteristic curve).



Danger due to electric current

In step "0" the frequency inverter is not switched off electrically but only no speed preset signal applied (= 0 V).

3.3 Maintenance

The device must be checked for soiling and, if necessary, cleaned in periodic intervals.

3.4 Transport

- The device is packed ex factory to suit the transport method previously agreed.
- Always use the original packaging materials when transporting the device.
- Avoid shocks and impacts to the device during the transport.
- During manual handling the human lifting and carrying restrictions must be observed and adhered to.

3.5 Storage

- The device must be stored in its original packaging in a dry and weather-proof room.
- Avoid exposure to extreme heat and cold.
- Avoid prolonged storage; we recommend a maximum of one year (consult the manufacturer before starting if stored for longer).

Get In Touch

☎ Call: 0845 6880112
✉ Email: info@adremit.co.uk

Our Address

Puravent, Adremit Limited, Unit 5a, Commercial Yard,
Settle, North Yorkshire, BD24 9RH

3.6 Disposal / recycling



Disposal must be carried out professionally and environmentally friendly in accordance with the legal stipulations.

4 Mounting

4.1 General notes



Attention!

The following points must be complied with during the mechanical installation to avoid causing a defect in the device due to assembly errors or environmental influences:

- Before installation remove the device from the packing and check for any possible shipping damage!
- Assemble the device on a clean and stable base. Do not distort during assembly! Use the appropriate mounting devices for proper installation of the unit!
- A mounting on vibrating base is not permissible, if no data to the vibration strength is made (☞ Technical data)!
- When mounted onto lightweight walls, there must be no impermissibly high vibrations or shock loads. Any banging shut of doors that are integrated into these lightweight walls, can result in extremely high shock loads. Therefore, we advise you to decouple the devices from the wall.
- Do not allow drilling chips, screws and other foreign bodies to reach the device interior!
- Maintain the stated minimum clearances to ensure unobstructed cooling- air feed as well as unobstructed outgoing air discharge (☞ minimum space requirement)!
- The device should be installed in a location where it will not be disturbed, but at the same time can be easily accessed!
- Depending on the housing model cut off necessary cable inlets respectively to the cable diameter. Or alternative use cable inlet for cable glands. Metal sheet housings are supplied with stoppers. Any cable ducts openings not used must be sealed!
- Care must be taken to avoid direct radiation from the sun!
- The device is designed for vertical installation (cable inlet down). A horizontal or reclined installation is only permissible after technical release of the manufacturer!
- Be sure to observe proper heat dissipation (☞ Technical data, heat dissipation).

4.2 Minimum space requirement

In order to ensure sufficient ventilation of the device, clearance on all sides of at least 50 mm has to be maintained to the housing walls, switch cabinet doors, wiring ducts, etc. The same clearance applies to the installation of several devices next to each other.

When installing several devices on top of each other, the danger of reciprocal heating exists. This layout is only then permissible when the air suctioned from the upper unit does not become warmer than the permissible ambient temperature (☞ Technical data). I.e., a correspondingly larger clearance or thermal shielding is required.

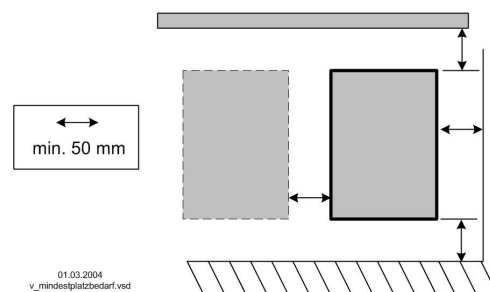

4.3 Outdoor installation

Outdoor installation is possible up to -20 °C when the controller supply is not switched off. Installation must be protected from the effects of weather as much as possible, including protection from direct sunlight!

Get In Touch

Call: 0845 6880112
Email: info@adremit.co.uk

Our Address

Puravent, Adremit Limited, Unit 5a, Commercial Yard,
Settle, North Yorkshire, BD24 9RH

4.4 Installation location for agriculture

In order to avoid damage caused by ammoniac vapours, the controller shall not be installed in the stable, but rather in an outhouse wherever possible.

4.5 Temperature influences during commissioning

Avoid condensation in the controller and functional faults attributable to condensation by storing the controller at room temperature!

5 Electrical installation

5.1 Safety precautions



Danger due to electric current

- **Work on electric components may only be carried out by trained electricians or by persons instructed in electricity under the supervision of an electrician in accordance with electrical engineering regulations.**
- The 5 electrical safety rules must be observed!
- It is forbidden to carry out work on electrically live parts. Even after disconnection, the dc-link is still live. Always wait at least 3 minutes.
- Other measures may be necessary to achieve safe electrical isolation.
- A second person must always be present when working on energized parts or lines who disconnects in case of emergency.
- Inspect electrical equipment periodically: retighten loose connections – immediately replace damaged lines and cables.
- Always keep switch cabinets and all electrical supply facilities locked. Access is only allowed for authorized persons using a key or special tool.
- Operating the device with the housing cover removed is prohibited because energized, exposed parts are present inside the device. Disregarding this regulation can lead to severe personal injury.
- For metal cable inlets the necessary protective earth connection to the bottom of the housing is made by screws. The device may only be started up when these screws are fitted properly.
- The device owner is responsible for the EMC of the entire plant according to the locally applicable standards.
- Never clean electrical equipment with water or similar liquids.



Information

The respective connections are represented in the enclosure of this manual (☞ Connection diagram)!

5.2 EMC-compatible installation

5.2.1 Motor cable

The applicable standard for interference emissions is EN 61000-6-3. Compliance with this standard is achieved through the use of an unscreened motor feed cable.

5.2.2 Control cables

Pay attention to sufficient distance from powerlines and motor wires to prevent interferences. The control cable may not be longer than 30 m. Screened control cables must be used when the cable length is longer than 20 m. When using a shielded cable connect the shielding to one side only, i.e. only to the control unit with the protective ground (keep cable short and with as little inductance as possible!).

5.3 Mains connection

5.3.1 Line voltage

Power from the mains is connected to terminals: PE, L1 and N. Here, it must be strictly observed that the mains voltage lies within the allowable tolerance specifications (☞ Technical data and nameplate affixed to the side).

A connection between two phase conductors is possible for 3 ~ 230 V supply networks.

Get In Touch

☎ Call: 0845 6880112
✉ Email: info@adremit.co.uk

Our Address

Puravent, Adremit Limited, Unit 5a, Commercial Yard,
Settle, North Yorkshire, BD24 9RH

**Attention!**

To activate the on current limitation, you must wait at least 90 seconds after switching off the line voltage before switching back on!

5.3.2 Required quality attributes for the mains voltage**Danger due to electric current**

The mains voltage must comply with the EN 50160 quality characteristics and the defined standard voltages in IEC 60038!

5.3.3 Leakage current, securely attached, protective earth conductor**Danger due to electric current**

The maximum leakage current depends on the type of device and the connected mains voltage (☞ Technical Data). With regard to fixed connection and the type of PE conductor connection, the specification for the leakage current must be observed under consideration of the locally valid standards (for Europe ☞ EN 50178 Section 5.2.11 or 5.3.2.1 etc.).

Minimum cross-section for PE conductor for fixed connection = 1.5 mm²!

5.4 Residual-current-operated protective device**Danger due to electric current**

To ensure as high a degree of reliability as possible we recommend a release current of 300 mA, where a residual current circuit breaker (type A) is used.



Residual current circuit breaker (type A)

Exception: All-current-sensitive fault current circuit breaker on the 3 ~ 230 V line

When connecting the device between two outer conductors, "all-current-sensitive" fault current circuit breakers must be used (☞ EN 50 178, Art. 5.2).

5.5 Inverter output**5.5.1 Motor connection**

The motor leads are connected to the terminals: U1, U2. Several fans can be connected to the controller-the maximum total current of all motors must not exceed the current rating for the controller. Change direction of rotation ☞ wiring diagram fan!

**Information**

- It is recommended that a separate motor protection unit be foreseen for each fan.
- For motors with thermistors "TB" e.g. type S-ET10.

5.5.2 Disconnection between controller and motor (repair switch)

Ideally, a repair switch should be installed **before the controller** (supply line disconnect). In the case of complete disconnection (entire load) after the controller, the enable (controller OFF / ON) must be disconnected simultaneously. I.e., an additional control contact is needed. Switching on the motor while simultaneously issuing the enable (ON) achieves secure energizing with low saturation of the controller.

**Attention!**

When switching on the motor plus existing release: under certain circumstances, this can occur under full modulation of the controller.

5.5.3 U/f-characteristic curve

A control signal for setting the output frequency is switched to the analog input of the device by the 5-step switch (0 - 10 V $\hat{=}$ 0 - 50 Hz).

Get In Touch

Call: 0845 6880112
 Email: info@adremit.co.uk

Our Address

Puravent, Adremit Limited, Unit 5a, Commercial Yard,
Settle, North Yorkshire, BD24 9RH

Diagram setting signal and U/f curve (linear)

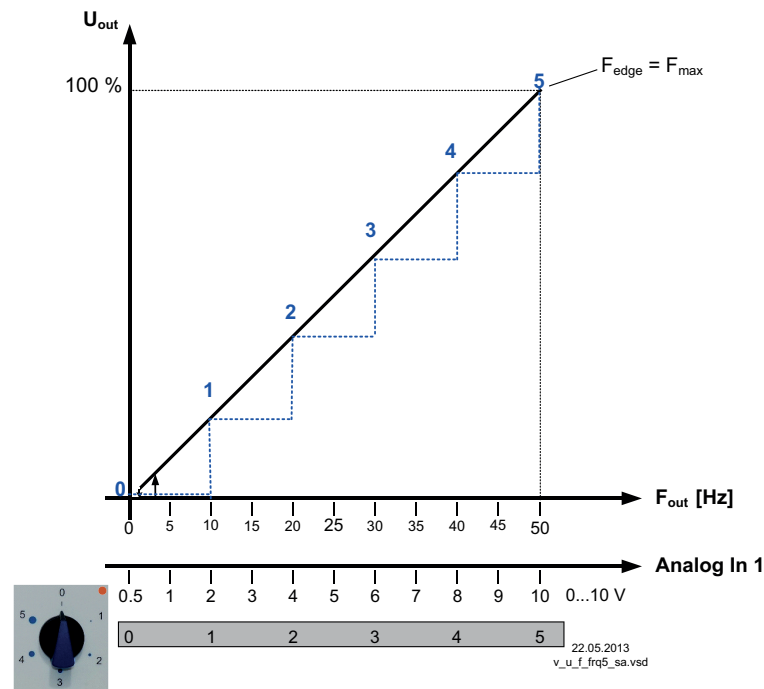

Analog In: Speed preset signal by 5-step switch

F_{out} : Output frequency

U_{out} : Output voltage

U_{start} : Start-up voltage

F_{off} : Shutdown Freq.

F_{edge} : Edgefrequency

F_{max} : Maximum frequency

Potentiometer for step adaptation

The device operates with the respective possible maximum frequency (see diagram) in every step in the as-delivered state.

The setting signal (0 - 10 V) for every step and thus the output frequency can be reduced with the internal potentiometer.

The reduction acts on all steps (1 – 5) in percentage relation. It might therefore be possible to prevent interference noises caused by resonances at certain frequencies.

Potentiometer adjustable with a screwdriver

- Left stop: No reduction, i.e. output frequency e.g. in step 5 = 50 Hz (factory setting see diagram)
- Right stop: Maximum reduction 25 %, i.e. output frequency, e.g. in step 5 = 37.5 Hz)

The value of the output frequency can be checked with a suitable measuring instrument!

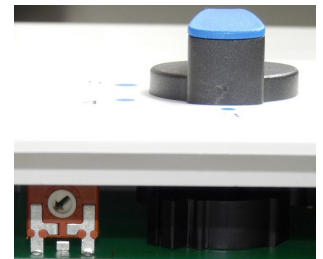

Potentiometer for step adaptation



Danger due to electric current

- It is generally forbidden to carry out work on electrical live parts. Protection class of the device when open is IP00! It is possible to touch hazardous voltages directly.
- The device must have been disconnected from the line voltage for at least 3 minutes before opening!
- Observe the safety information!

5.6 Motor protection

The motor can be protected by connecting thermostats "TB".

When multiple motors are connected, it is essential to ensure that thermostats "TB" are always connected in series.

Get In Touch

Call: 0845 6880112
Email: info@adremit.co.uk

Our Address

Puravent, Adremit Limited, Unit 5a, Commercial Yard,
Settle, North Yorkshire, BD24 9RH

If a connected thermostat is tripped (break between the two terminals “TB”), the device is switched off and is not switched back on.

Relais “K2” is de-energized, terminals “21” - “22” bridged. The signal lamp flashes in code  (Diagnostics / faults).

Possibilities for re-starting after the drive has cooled down (terminals “TB” bridged) by:

- By switching the mains voltage off and then on again.
- Via a digital input for remote control (ON / OFF enable).



Danger due to electric current

An outside voltage may never be connected to the terminals “TB”!

If a bypass circuit is installed, or in the “100 %” position on devices with a main switch, the motor protection inside the controller has no function. In this case, additional motor monitoring may be required.

5.7 Enable, Device ON / OFF (Digital In 1 = D1)

Electronic disconnection and Reset after motor fault via floating contact at terminals “D1” - “D1”

- Device “ON” for closed contact.
- Controller “OFF” with opened contact.

Activation via floating contacts, a low voltage of approx. 24 V DC is connected.



Danger due to electric current

- No disconnection (isolation) when turned off by remote, in accordance with VBG4 §6!
- Never apply line voltage to the digital input!

5.8 Relay outputs (K2)

An operating message or activation of a damper control motor is possible via the potential-free contacts of the relay “K2” (max. contact load  technical data and connection diagram).

At a modulation above 5 Hz the relay energizes, i.e. the terminals “21” and “24” are bridged.

At low modulation (below 3 Hz), switch off by the enable, switch off of line voltage or in case of a fault, the relay de-energizes.

5.9 Bypass circuit

Please observe the following during bypass switching (controller shunt with mains voltage):

- Mutual locking of mains contactor and bypass protection.
- Time delay of at least 1 second during switching.
- When the contactor is switched off at the inverter output, the “enable” (ON / OFF) must also be opened and closed again when it is switched back on. When switching off, wait at least 90 seconds before switching back on!
- Never apply line voltage to the inverter output!

5.10 Potential at control voltage connections

The control voltage connections (< 50 V) relate to the joint GND potential (Exception: Relay contacts are potential free). There is a potential separation between the control voltage connections and the protective earth. It must be ensured that the maximum external voltage at the control voltage connections cannot exceed 50 V (between “GND” terminals and “PE” protective earth). If necessary, a connection to the protective earth potential can be established, install bridge between “GND” terminal and the “PE” connection (terminal for screening).

6 Start-up

6.1 Prerequisites for commissioning



Attention!

1. You must mount and connect the device in accordance with the operating instructions.
2. Double check that all connections are correct.
3. The mains voltage must match the information on the rating plate.
4. The rated current on the rating plate will not be exceeded.
5. Make sure that no persons or objects are in the hazardous area.

7 Diagnostics / Faults

Operating conditions are indicated by the status LED with flashing code.

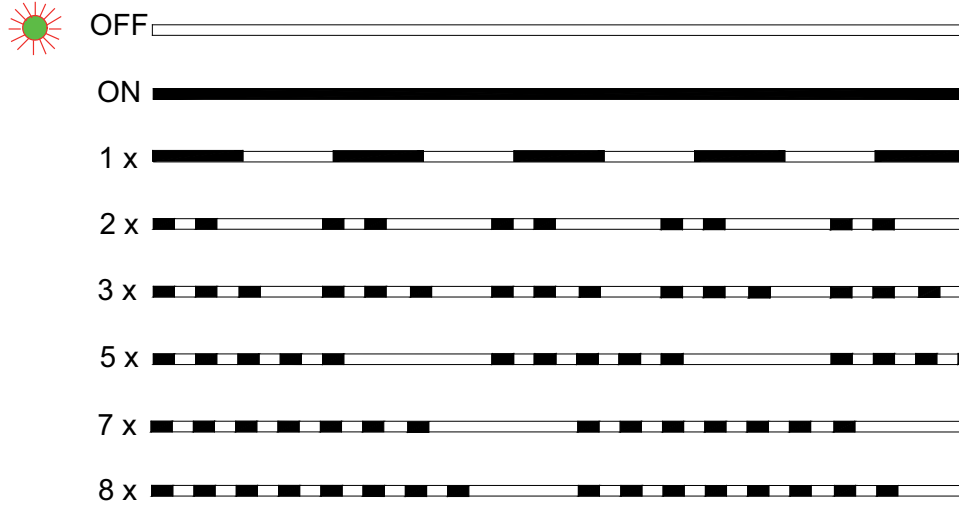

04.01.2012
v_flash_explain1_8.VSD

Code	Relay K2	Explanation	Reaction of Controller
			Adjustment
OFF	de-energized terminals 21 - 22 bridged	No line voltage	In the event of a mains interruption the unit switches "OFF" and automatically "ON" when the voltage has been restored. Check line voltage and pre-fusing.
ON	Energized at modulation above 5 Hz (terminals 21 - 24 bridged). De-energized at modulation below 3 Hz (21 - 22 bridged).	Normal operation without fault	
1	de-energized, 21 - 22 bridged	No enable = OFF Terminals "D1" - "D1" (Digital In 1) not bridged.	Switch off by external contact (enable, device ON / OFF).
2	de-energized terminals 21 - 22 bridged	Motor fault Tripping of connected thermostat or break between terminals "TB".	The unit cuts out and does not switch on again. Check motor and connection then reset (Motor protection).
3	Energized at modulation above 5 Hz (terminals 21 - 24 bridged). De-energized at modulation below 3 Hz (21 - 22 bridged).	Temperature management active The device has an active temperature management to protect it from damage due to too high inside temperatures. In case of a temperature rise above the fixed limits, the modulation is reduced linearly. To prevent the complete system being switched off externally (in this operation permissible for the controller) in case of reduced operation due to too high an internal temperature, no fault message is sent via the relay.	With a drop in temperature the modulation rises again linearly. Check cooling of the controller
5	de-energized terminals 21 - 22 bridged	Overcurrent The controller was switched off by the current limitation. Delay: 1.25 sec by continuous overcurrent. Immediately switch off after 16th short (< 1.25s) overcurrent. If for 60seconds no short fault the fault counter goes back to 0. Switch back time: 60 sec.	Controller turns the motor off. There is a renewed attempt to start after about one minute. Check motor

Get In Touch

Call: 0845 6880112
 Email: info@adremit.co.uk

Our Address

Puravent, Adremit Limited, Unit 5a, Commercial Yard, Settle, North Yorkshire, BD24 9RH

Code	Relay K2	Explanation	Reaction of Controller
			Adjustment
7	de-energized terminals 21 - 22 bridged	Earth fault Shortcut between one motor wire and PE	The unit cuts out and does not switch on again.
			Disconnect the device from mains.
			Check motor wires
			A permanent shortcut earth can damage the device!
8	-	Overvoltage DC overvoltage because of shortcut earth at switch-on.	The unit cuts out.
			Disconnect the device from mains.
			Check motor wires

8 Enclosure

8.1 Technical data

Type	FRQ5S-E-6A	FRQ5S-E-10A
Part-No.	37421 (308307-42)	37422 (308308-42)
Rated current output {1}	6 A	10 A
Rated current input {2}	6.3 A	10.8 A
Max. load limit integral of cut-in current {2}	0,7	1,3
Max. line fuse {3}	10 A	16 A
Max. leakage current according to the dented networks of DIN EN 60990 (depending on connected line voltage *)	2.6 mA (U _{typ} 230 V) 3.5 mA (U _{max} 305 V)	3.0 mA (U _{type} 230 V) 4.0 mA (U _{max} 305 V)
Max. heat dissipation approx. {2}	103 W	187 W
Rated temperature	40 °C	50 °C
Weight	5.7	6.7 kg

{1} Rated current output \triangleq current indication rating plate @ rated voltage, @ rated temperature (cos φ 0.8 at the output)

{2} At rated voltage (cos φ 0.8 at the output), values for different specifications on request.

{3} Max. supply side line fuse according to DIN EN 60204-1 classification VDE0113 chapter 1

Line voltage*	1 ~ 208...277 V (-10...+10 %), 50/60 Hz
Rated voltage	230 V
Maximal output voltage	1 ~ 230 V The PFC (Power Factor Controller) makes it mostly independent of the mains voltage
Maximal output frequency	50 Hz
Edgefrequency	50 Hz
U/f-characteristic curve	linear
Switching frequency	16 kHz
Rampup time	20 sec
Rampdown time	20 sec
Power factor	> 0.9
Heat dissipation in standby operation	approx. 2.6 W
Max. contact rating of the internal relay	2 A / 250 VAC
Max. permissible ambient temperature	55 °C
Min. permissible ambient temperature	0 °C (if mains voltage is not switched off up to -20 °C)
Max. permissible installation height	0...4000 m amsl above 1000 m amsl the rated current is to be reduced by 5 % / 1000 m
Permissible rel. humidity	85 % no condensation
Electromagnetic compatibility for the standard voltage 230 / 400 V according to DIN IEC 60038	Interference emission EN 61000-6-3 (domestic household applications) Interference immunity EN 61000-6-2 (industrial applications)

L-BAL-E247-GB 1512 Index 001

Part.-No. 00163444-42
14/17
 systemair

Get In Touch

 Call: 0845 6880112
 Email: info@adremit.co.uk

Our Address

Puravent, Adremit Limited, Unit 5a, Commercial Yard,
Settle, North Yorkshire, BD24 9RH

Harmonics current	Active power factor adjustment for sinusoidal input current (PFC = Power Factor controller), harmonic current in accordance with EN 61000-3-2 are guaranteed
Vibratory strength (for vertical installation, i.e. cable inlet down).	Broadband noise (simulated life-endurance test) in accordance with EN 61373, category 1 class B. Shock test according to EN 61373, category 1
Housing protection	IP54

* Regarding the mains connection, these devices are to be classified as category "C2" devices according to the relevant DIN EN 61800-3. The increased requirements placed on electrical interference > 2 kHz for category "C1" devices are complied with in addition.

8.1.1 Max. load dependent on ambient temperature and line voltage.



The maximum permissible temperature for the rated current at rated voltage is specified as rated temperature.

Since the dissipation of the power loss (heat development) in the device is decisively dependent on the ambient temperature, the max. load must be reduced at an ambient temperature above the rated temperature (see following table)!

The average value measured during a 24 h period must be 5 K under the max. ambient temperature. For installation in a switch cabinet, the device's dissipation and its possible affect on the ambient temperature must be taken into consideration!

Type	Maximal motor current depending on ambient temperature			
	@ 40 °C [A]	@ 45 °C [A]	@ 50 °C [A]	@ 55 °C [A]
FRQ(5)-E-6A	6.0	5.5	4.5	4.0
FRQ(5)-E-10A	10.0	10.0	10.0	9.0

Get In Touch

 Call: 0845 6880112
 Email: info@adremit.co.uk

Our Address

Puravent, Adremit Limited, Unit 5a, Commercial Yard,
Settle, North Yorkshire, BD24 9RH

8.2 Connection diagram

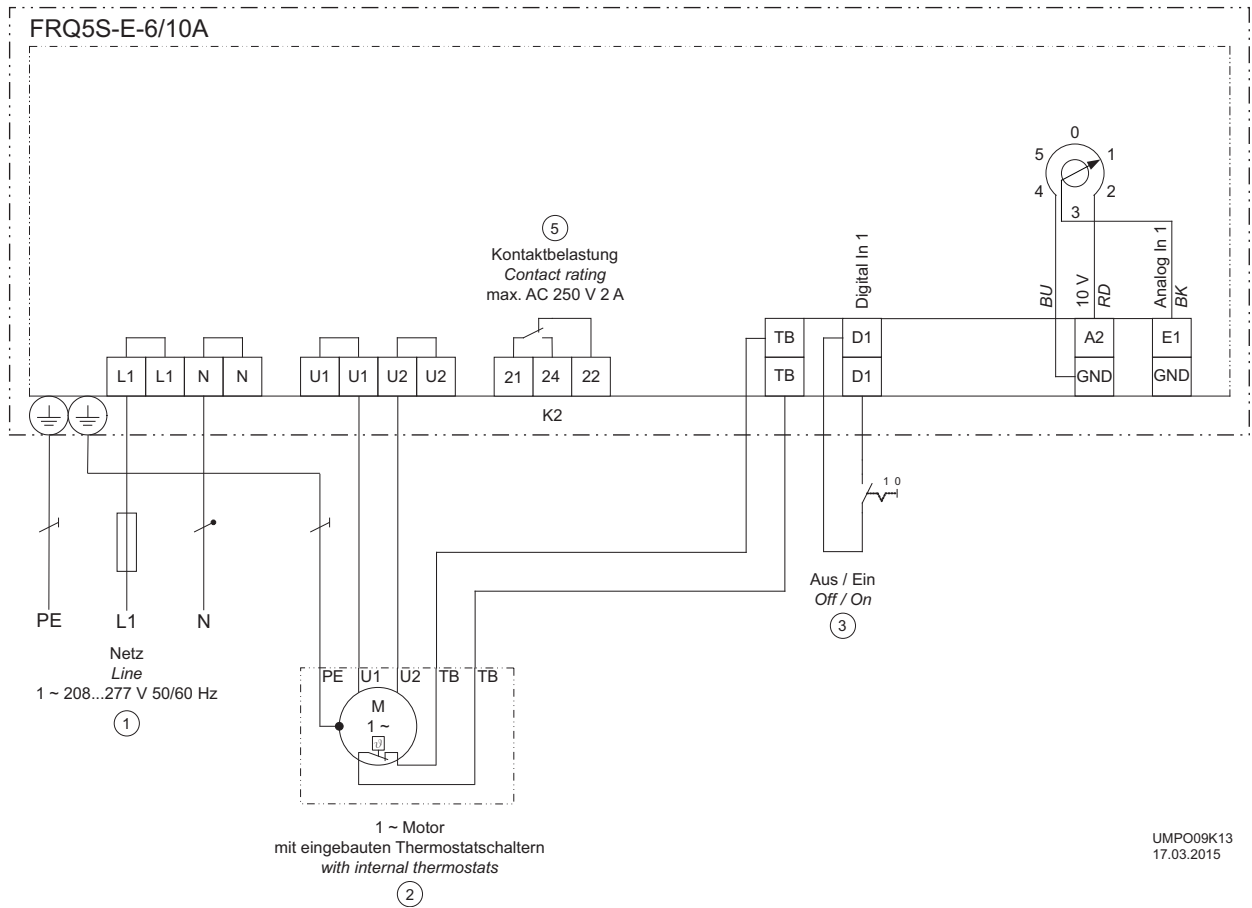

- 1 Line 1 ~ 208...277 V, 50/60 Hz
- 2 1 ~ Motor with internal thermostats
- 3 Enable off / on
- 4 Contact rating max. AC 250 V 2 A

8.3 Dimensions [mm]

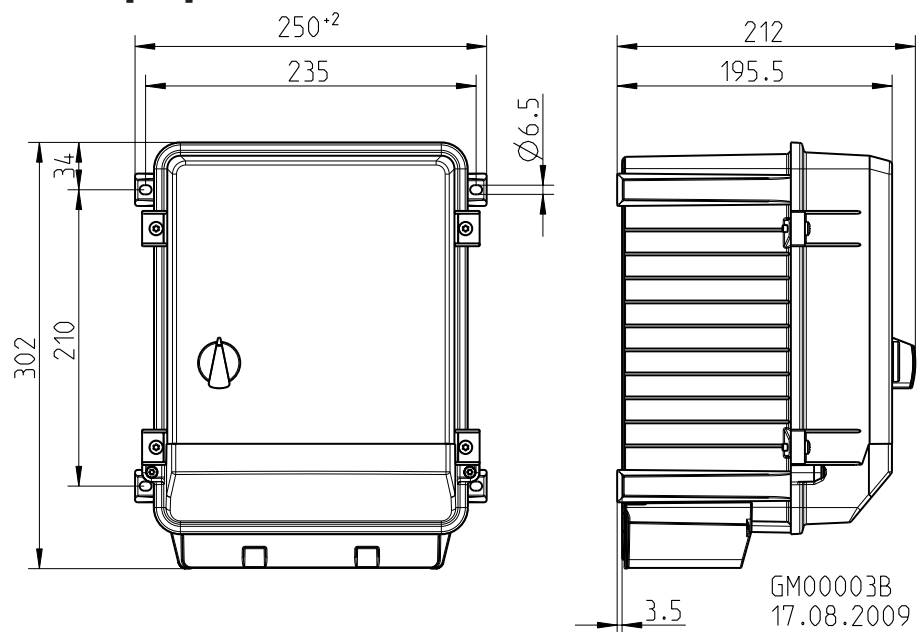

Representation of the switch position subject to change!

8.4 Manufacturer reference

Our products are manufactured in accordance with the relevant international regulations. If you have any questions concerning the use of our products or plan special uses, please contact:

Systemair
Industrievägen 3
73930 Skinnskatteberg
Telefon:+46 (0) 222 440 00
Telefax:+46 (0) 222 440 99
mailbox@systemair.se
www.systemair.se

Get In Touch

 **Call:** [0845 6880112](tel:08456880112)
 **Email:** info@adremit.co.uk

Our Address

Puravent, Adremit Limited, Unit 5a, Commercial Yard,
Settle, North Yorkshire, BD24 9RH