



UPA

AIR PURIFYING UNITS

GERMICIDAL UVc
ULTRAVIOLET
LAMP



- PURIFIES INDOOR AIR
- IMPROVES HEALTH
- CLEANS PARTICLES AND ODOURS
- PERFECT FOR INDUSTRY AND HIGH OCCUPATION PREMISES
- OPTIMAL FOR DATA CENTRES
- SUITABLE FOR PHARMACEUTICAL AND HEALTHCARE INDUSTRIES



STAGES OF FILTRATION

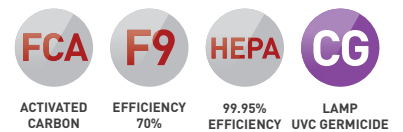

Get In Touch

Call: 0845 6880112
 Email: info@adremit.co.uk

Our Address

Puravent, Adremit Limited, Unit 5a, Commercial Yard,
 Settle, North Yorkshire, BD24 9RH



UPA

Units specifically designed for cleaning and purification of indoor air, in any type of premises and especially in areas with high occupancy, also suitable for pharmaceutical and healthcare applications.



Features:

- Plug-fan type fans with EC technology.
- Efficient, adjustable and low noise level equipment.
- Filtration stages according to model
 - First stage of F7 Filtering.
 - Activated carbon filter.
 - Final filter F9.
 - HEPA H14 final filter, 99.95% efficiency.
 - UVc germicidal chamber, depending on order code.
- Control panel with on / off and dirty filters indicator.
- Two speed selector.
- Germicidal chamber operation led indicator.
- Fully removable access door for cleaning and maintenance
- Insulated panels.

Motor:

- High efficiency, external rotor, E.C. technology motors, incorporating constant flow regulation, with two, pre-adjustable set points.
- Single phase 200-230V– 50 / 60Hz.

Finish:

- Frames made form aluminum section and 25mm insulated panels, pre-finished exterior, galvanized interior.

On demand:

- Drive Module 1 Front grille.
- Drive module with circular ducts.
- Equipped with wheels.

Order code

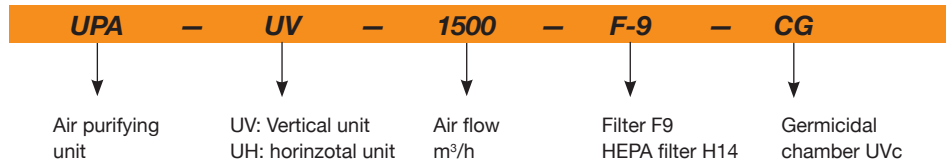

Technical characteristics

Model	Recommended effective working area ¹ (m²)	Maximum flow (m³/h)	(CFM)	Available pressure (Pa)	Power supply (V)	Sound level dB(A)	Fan (KW)	Weight (kg)
UPA-UV-1500	200-350	1.500	883	250	200-230V 50/60Hz 1Ph	47	0,76	113
UPA-UV-3000	300-450	3.000	1766	250	200-230V 50/60Hz 1Ph	51	1,35	140
UPA-UV-4500	450-900	4.500	2649	300	200-230V 50/60Hz 1Ph	55	2,7	177
UPA-UV-6000	900-1.100	6.000	3531	250	200-230V 50/60Hz 1Ph	59	5,4	215
UPA-UH-1500	200-350	1.500	883	250	200-230V 50/60Hz 1Ph	47	0,76	108
UPA-UH-3000	300-450	3.000	1766	250	200-230V 50/60Hz 1Ph	52	1,52	138
UPA-UH-4500	450-900	4.500	2649	250	200-230V 50/60Hz 1Ph	55	2,7	135
UPA-UH-6000	900-1.100	6.000	3531	250	200-230V 50/60Hz 1Ph	59	5,4	155

¹ Recommended area with a 3 meter high premises. * Available pressure with G4 and F9 filter

Construction

Vertical Unit (UV)

Vertical Unit (UV) ideal for direct use in the rooms being purified, it can also be supplied on request with a drive module with outlet diffusion grille and with wheels if required.

Horizontal Unit (UH)

Horizontal Unit (UH) deigned to be installed in ceiling spaces and ducted to the areas where the air needs to be treated.

Get In Touch

Call: 0845 6880112
Email: info@adremit.co.uk

Our Address

Puravent, Adremit Limited, Unit 5a, Commercial Yard, Settle, North Yorkshire, BD24 9RH

Dimensions mm

Vertical Unit

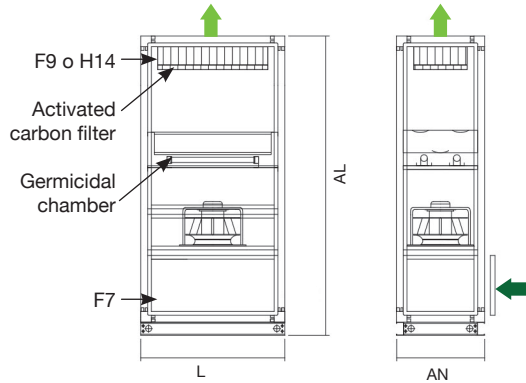

Model	L (mm)	AN (mm)	AL (mm)
UPA-UV-1500	774	474	1600
UPA-UV-3000	774	779	1600
UPA-UV-4500	1079	779	1600
UPA-UV-6000	1504	779	1600

*Data subject to change without prior notice.

Horizontal Unit

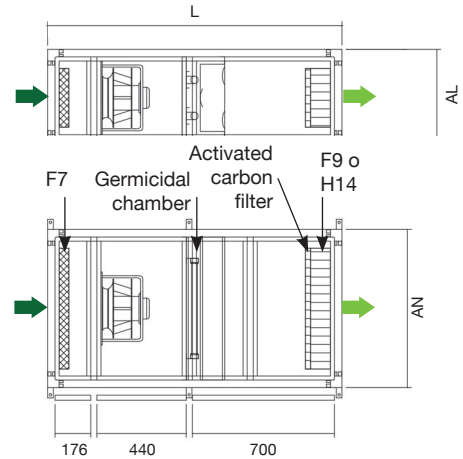

Model	L (mm)	AN (mm)	AL (mm)
UPA-UH-1500	1450	774	479
UPA-UH-3000	1450	1366	479
UPA-UH-4500	1450	1069	779
UPA-UH-6000	1450	1366	779

*Data subject to change without prior notice.

Drive modules

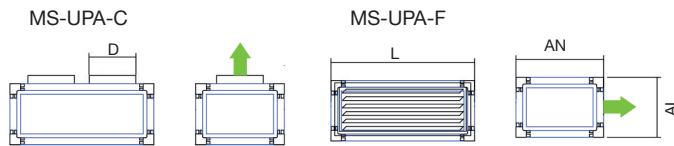

Model	L (mm)	W (mm)	H (mm)	D (mm)	Number of ducts	Weight (Kg)
MS-UPA-1500	774	474	324	250	2	25
MS-UPA-3000	774	779	490	250	4	33
MS-UPA-4500	1079	779	490	250	6	42
MS-UPA-6000	1504	779	490	-	-	55

Filtered

These air purification units are equipped with filters capable of removing at least 70% of particles larger than 0.4µm.

The standard model comes with a first G-4 filter stage and a final F-9 filter, it also incorporates as standard, an activated carbon stage, designed to remove stale odours produced during everyday use of the premises.

Depending on model type H14 HEPA filters can be installed with a minimum retention capacity of 99.95% for particles larger than 0.3µm.

Filters	EN 779 Em	EN 1822	ISO 16890			
			ISO ePM ₁	ISO ePM _{2.5}	ISO ePM ₁₀	ISO COARCE
G4	90%	-	-	-	-	>90%
F7	90%	-	>50%	>65-95%	>85%	-
F9	95%	-	>80%	>95%	>95%	-
HEPA H14	-	>99,995%	-	-	-	-

Technical characteristics of the UVC germicidal lamp

Depending on model and on request, these purification units can be supplied with an integrated germicidal chamber using UV "C" ultraviolet lamps, in the spectrum of 256 nm wave amplitude to inactivate a wide variety of microorganisms by absorbing short wavelength energy through DNA and RNA.

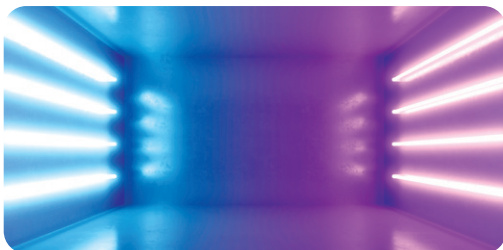

Model	Number of lamps	Total electrical power (W)	Total UVC radiation power (W)	Dose ratio* (mJ/cm ²)
CG-UV-1500	3	48	21	4,85
CG-UV-3000	7	112	48	5,66
CG-UV-4500	4	216	70	5,39
CG-UV-6000	14	224	98	5,47
CG-UH-1500	3	48	21	5,17
CG-UH-3000	2	150	51	6,28
CG-UH-4500	4	216	70	5,89
CG-UH-6000	14	224	98	6,04

*Minimum dose calculated based on flow with F7 +F9 filters

Get In Touch

Call: 0845 6880112
Email: info@adremit.co.uk

Our Address

Puravent, Adremit Limited, Unit 5a, Commercial Yard, Settle, North Yorkshire, BD24 9RH

**HEADQUARTERS****Sodeca, S.L.U.**

Pol. Ind. La Barricona
Carrer del Metall, 2
E-17500 Ripoll
Girona, SPAIN
Tel. +34 93 852 91 11
Fax +34 93 852 90 42
General sales: comercial@sodeca.com
Export sales: ventilation@sodeca.com

PRODUCTION PLANT**Sodeca, S.L.U.**

Ctra. de Berga, km 0,7
E-08580 Sant Quirze de Besora
Barcelona, SPAIN
Tel. +34 93 852 91 11
Fax +34 93 852 90 42
General sales: comercial@sodeca.com
Export sales: ventilation@sodeca.com

**EUROPE****FINLAND****Sodeca Finland, Oy**

HUITTINEN
Sales and Warehouse
Mr. Kai Yli-Sipilä
Metsälinnankatu 26
FI-32700 Huittinen
Tel. + 358 400 320 125
orders.finland@sodeca.com

HELSINKI
Smoke Control Solutions
Mr. Antti Kontkanen
Vilppulantie 9C
FI-00700 Helsinki
Tel. +358 400 237 434
akontkanen@sodeca.com

HYVINKÄÄ
Industrial Applications
Mr. Jaakko Tomperi
Niinistökatu 12
FI-05800 Hyvinkää
Tel. +358 451 651 333
jtomperi@sodeca.com

ITALIA**Marelli Ventilazione, S.R.L.**

Sr. Christian Tosetti
Viale del Lavoro, 28
37036 San Martino B.A.
(VR), ITALY
Tel. +39 045 87 80 140
Fax +39 045 99 22 24
info@marelliventilazione.com

PORTUGAL**Sodeca Portugal, Unip. Lda.**

PORTO
Rua Veloso Salgado 1120/1138
4450-801 Leça de Palmeira
Tel. +351 229 991 100
geral@sodeca.pt

LISBOA
Pq. Emp. da Granja Pav. 29
2625-607 Vialonga
Tel. +351 219 748 491
geral@sodeca.pt

ALGARVE
Rua da Alegria S/N
8200-557 Cortesões
Tel. +351 289 092 586
geral@sodeca.pt

UNITED KINGDOM**Sodeca Fans UK, Ltd.**

Mr. Mark Newcombe
Tamworth Enterprise Centre
Philip Dix House, Corporation
Street, Tamworth, B79 7DN
UNITED KINGDOM
Tel. +44 (0) 1827 216 109
sales@sodeca.co.uk

AMERICA**CHILE****Sodeca Ventiladores, SpA.**

Sra. Sofía Ormazábal
Santa Bernardita 12.005
(Esquina con Puerta Sur)
Bodegas 24 a 26,
San Bernardo, Santiago, CHILE
Tel. +56 22 840 5582
ventas.chile@sodeca.com

COLOMBIA**Sodeca Latam, S.A.S.**

Sra. Luisa Stella Prieto
Calle7 No. 13 A-44
Manzana 4 Lote1, Montaña
Mosquera, Cundinamarca
Bogotá, COLOMBIA
Tel. +57 1 756 4213
ventascolombia@sodeca.co

PERU**Sodeca Perú, S.A.C.**

Sr. Jose Luis Jiménez
C/ Mariscal Jose Luis de
Orbegoso 331. Urb. El pino,
15022, San Luis. Lima, PERÚ
Tel. +51 1 326 24 24
Cel. +51 994671594
comercial@sodeca.pe

RUSSIA**RUSSIA
Sodeca, L.L.C.**

Mr. Stanislav Alifanov
Severnoye Shosse, 10 room 201
Business Park Plaza Ramstars
140105 Ramenskoye,
Moscow region, RUSSIA
Tel. +7 495 955 90 50
alifanov@sodeca.com



www.sodeca.com

**Get In Touch**

 **Call:** 0845 6880112
 **Email:** info@adremit.co.uk

Our Address

Puravent, Adremit Limited, Unit 5a, Commercial Yard,
Settle, North Yorkshire, BD24 9RH