



F251-16-60 COOKERHOOD TRANSF

Item no. 5931

Document type: **Product card**
 Document date: **2019-08-01**
 Generated by: **Systemair Online Catalogue**

Description

- Provides good lighting
- Easy to clean
- Available in 3 widths

The Systemair kitchen extract hood provides an elegant and easily adaptable ventilation system for your kitchen. The high capacity hood has a rigid area with a front screen of hardened sheet glass. The hood provides excellent light for kitchen work and is fitted with a wire mesh filter that is easy to clean. This filter should be cleaned at least once a month, either by hand or in the dishwasher. Simple connections with our flexible ducting.



The F 251-16 hood is fitted with a transformer with a three-speed fan control, grease filter, light and damper. The hood is supplied with an already-fitted quick-coupling device for installation with the kitchen shelf fans.

The versions -50, -60 and -70 indicates the width of the hood.

-60 is available in stainless steel finish.

Technical parameters

Other	
Weight	8,55 kg
Default group	
Voltage	230 V
Frequency	50 Hz
Phase	1 ~
Input power (P1)	300 W
Material in filter	Knitted alu. carpet

Dimensions

- A Handle for fan motor/damper
- B Button for lighting
- C Fan speed, three steps
- D General house ventilation.low speed
- E General house ventilation, force speed
- F Indecator lamp for general house ventilation, force speed

Get In Touch

- Call: [0845 6880112](tel:08456880112)
- Email: info@adremit.co.uk

Our Address

Puravent, Adremit Limited, Unit 5a, Commercial Yard,
 Settle, North Yorkshire, BD24 9RH

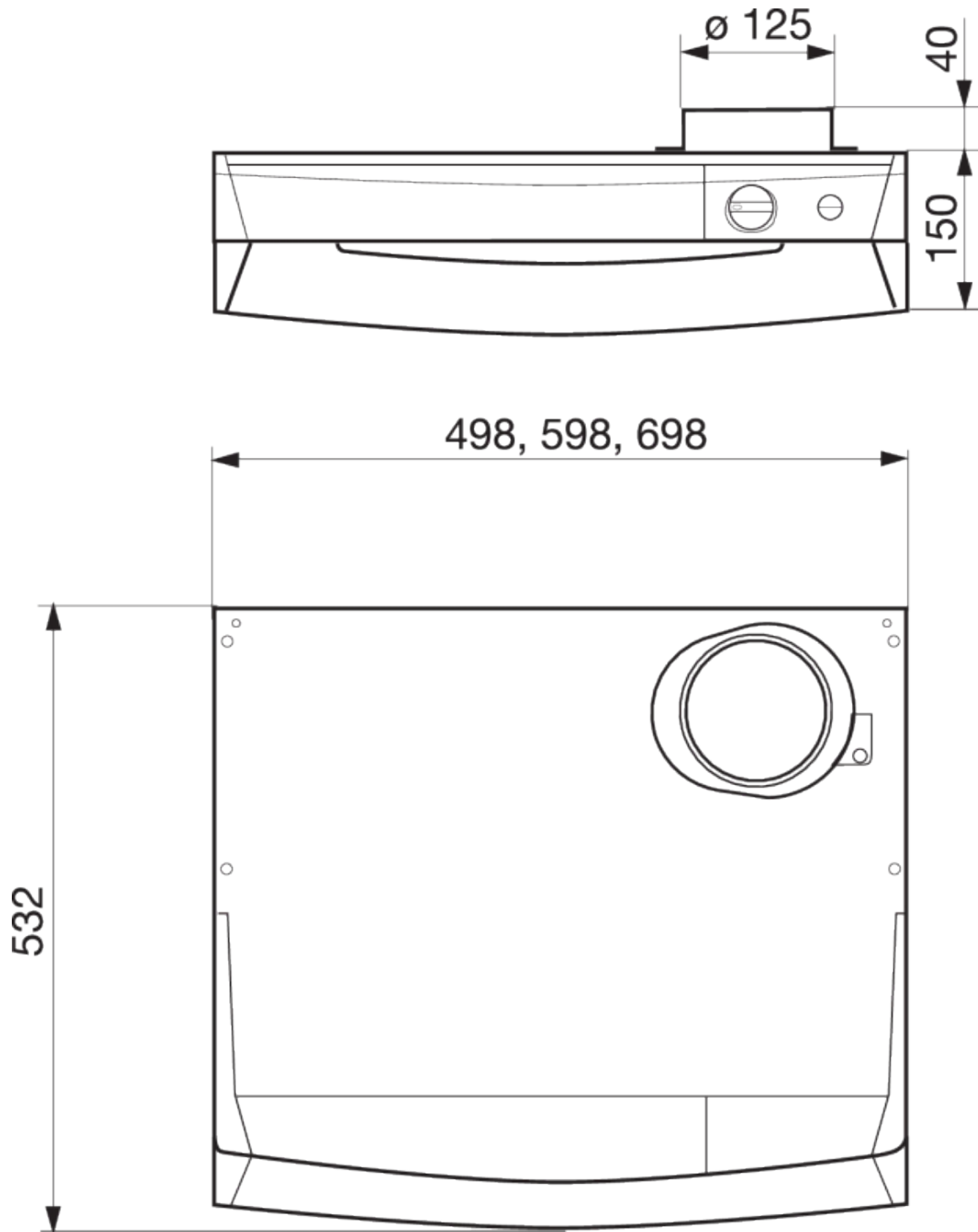



Name: **F251-16-60 COOKERHOOD TRANSF** | Item no.: **5931**

Document type: **Product card** | Document date: **2019-08-01** | Generated by: **Online catalogue**

2 / 4

Get In Touch

 Call: [0845 6880112](tel:08456880112)
 Email: info@adremit.co.uk

Our Address

Puravent, Adremit Limited, Unit 5a, Commercial Yard,
Settle, North Yorkshire, BD24 9RH

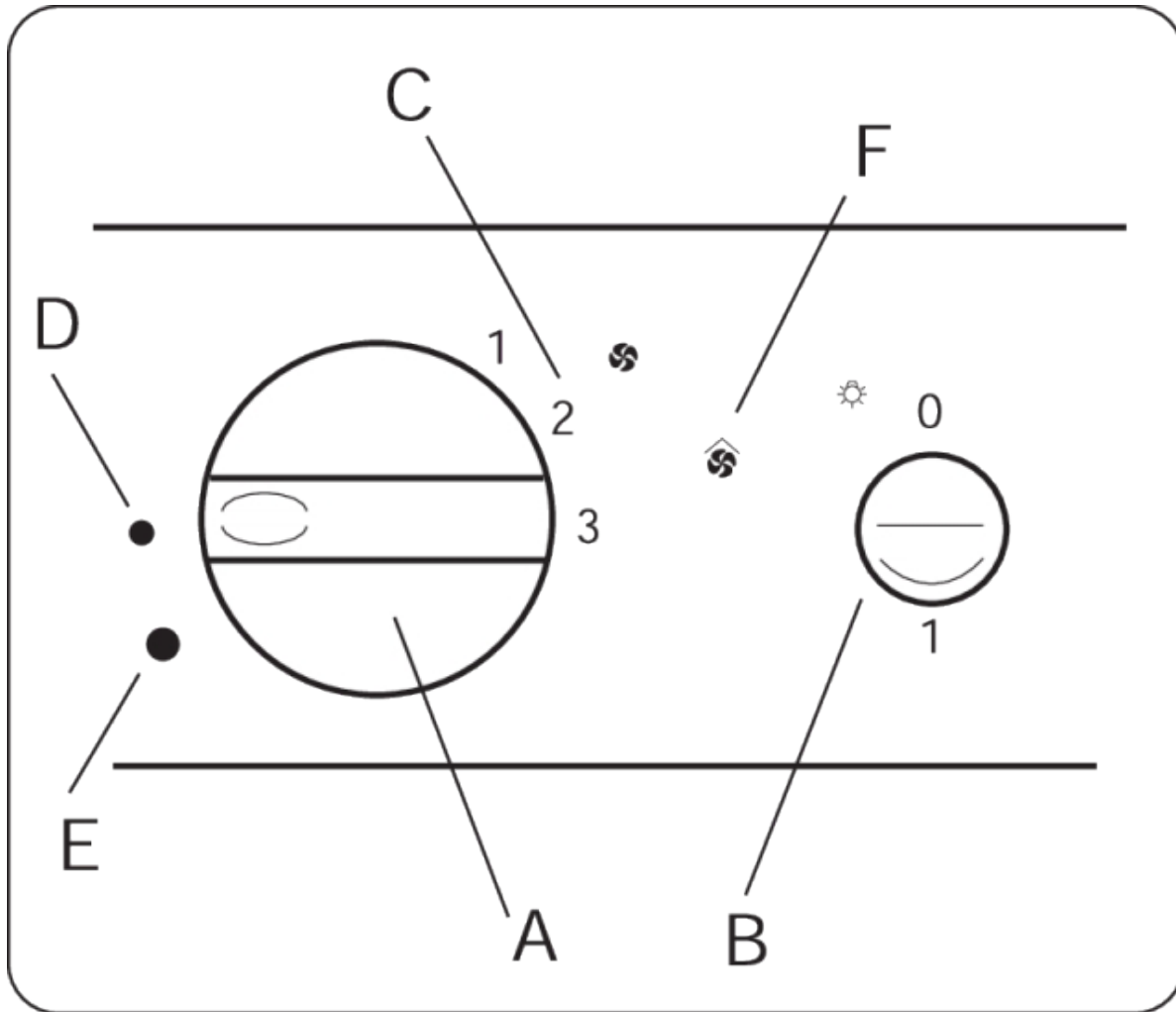

Accessories

Documentation

 F 251-16 IMO 122648.pdf (312,11kB)

 F 251-16 WD.pdf (1,96MB)

Get In Touch

 **Call:** [0845 6880112](tel:08456880112)
 **Email:** info@adremit.co.uk

Our Address

Puravent, Adremit Limited, Unit 5a, Commercial Yard,
 Settle, North Yorkshire, BD24 9RH

Diagram

Setting Forced flow

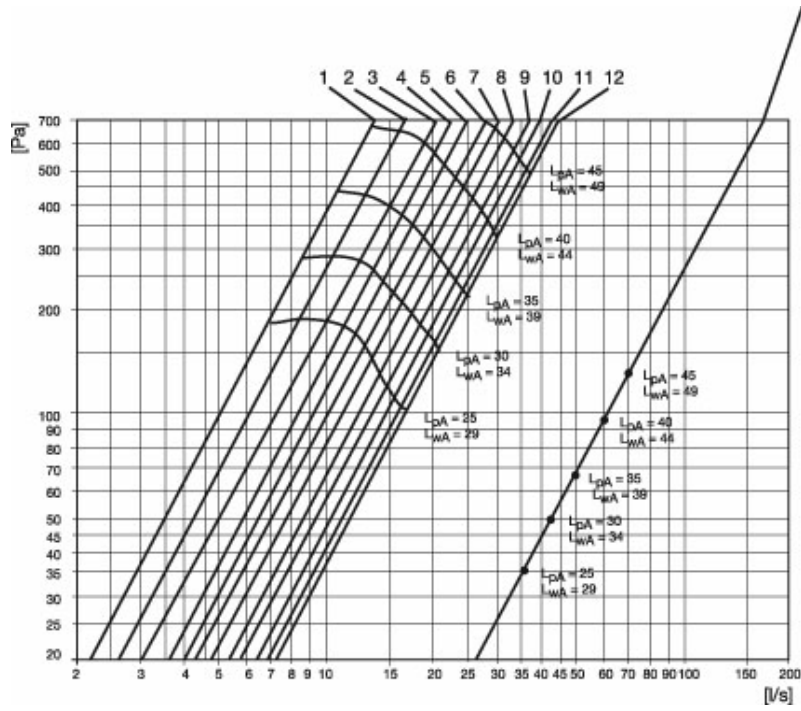

Specification text

Name: **F251-16-60 COOKERHOOD TRANSF** | Item no.: **5931**

4 / 4

Document type: **Product card** | Document date: **2019-08-01** | Generated by: **Online catalogue**

Get In Touch



Call: [0845 6880112](tel:08456880112)



Email: info@adremit.co.uk

Our Address

Puravent, Adremit Limited, Unit 5a, Commercial Yard,
Settle, North Yorkshire, BD24 9RH