

# eliturbo<sup>®</sup>

SYSTEM

## Air Mixer Eliturbo



Install, use and maintenance instructions



### Get In Touch

 Call: [0845 6880112](tel:08456880112)  
 Email: [info@adremi.co.uk](mailto:info@adremi.co.uk)

### Our Address

Puravent, Adremi Limited, Unit 5a, Commercial Yard,  
Settle, North Yorkshire, BD24 9RH

## Index

Eliturbo® air mixer product introduction.....	3
<b>1 - Generic information .....</b>	<b>4</b>
1.1 Receiving the equipment .....	4
1.2 Storing.....	4
1.3 Unpacking .....	4
1.4 Handling and transport.....	4
<b>2 - Technical information .....</b>	<b>5</b>
2.1 Technical characteristics .....	5
2.2 Product use .....	5
2.3 Wrong use.....	5
<b>3 - Installing .....</b>	<b>6</b>
3.1 General warnings for the installation .....	6
3.2 Installing the Eliturbo® air mixer.....	6
3.3 Electrical connections .....	8
3.4 Start up.....	9
<b>4 - Risks .....</b>	<b>9</b>
<b>5 - Emergency situations .....</b>	<b>9</b>
<b>6 - Use .....</b>	<b>9</b>
6.1 Switch on and off .....	9
6.2 Suggested use .....	9
6.3 End of season switch off .....	10
<b>7 - Maintenance.....</b>	<b>10</b>
<b>8 - Dismantling.....</b>	<b>10</b>

### Impresind Srl

Production facility: Via Primo Maggio 24, Gorgonzola (Milano, Italy)

☎ +39 02 95741932

☎ +39 02 95740637

✉ [impresind@impresind.it](mailto:impresind@impresind.it)

🌐 [www.impresind.it](http://www.impresind.it)



### *Information for the end user*

*This instruction manual is part of the product and has to be accessible easily by the end user and maintenance authorised personnel.*

*The end user and maintenance authorised personnel are obliged to read all the contents of this instruction manual before the first start up of the product.*

*In case of loss or damage of the instruction manual request a copy of it to who has supplied the products.*

### Get In Touch

☎ Call: [0845 6880112](tel:08456880112)

✉ Email: [info@adremit.co.uk](mailto:info@adremit.co.uk)

### Our Address

Puravent, Adremit Limited, Unit 5a, Commercial Yard,  
Settle, North Yorkshire, BD24 9RH

## Eliturbo® air mixer product introduction

Eliturbo® is an air mixer that is able to horizontally and vertically even the air temperature, to even the humidity and to reduce the running costs for heating and cooling in large buildings.

Eliturbo® uses a special helicentrifugal rotor that mixes the air, it does not create annoying air currents that can bother workers, it is manufactured complying with the security norms and the environment's hygiene norms.

The Eliturbo® air mixer, differing from the other ceiling fans, doesn't direct the airflow down and in concentrated areas, but it distributes the air in a radial horizontal way in large areas with an imperceptible ventilation.

The air stratification phenomenon and heat accumulation near the ceiling, in large volume buildings, is very common and is the cause of high energy costs for heating the premises.



An Eliturbo® air mixer system prevents the air stratification phenomenon, reduces the energy consumptions and improves the environment comfort.

The use of Eliturbo®'s exclusive air mixing improves the environment conditions even during the summer season when, caused by high temperature and high percentage of relative humidity, a micro climate, intolerable by personnel and structures, is generated.

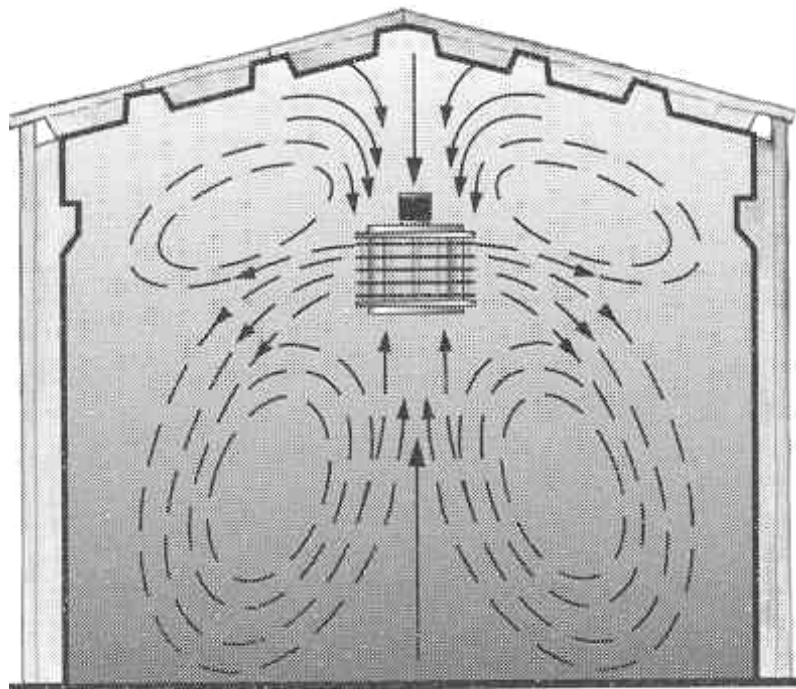
The Eliturbo® air mixer creates a constant air exchange through the open windows and other openings, keeping an active ventilation of the environment.



### Get In Touch

 Call: [0845 6880112](tel:08456880112)  
 Email: [info@adremit.co.uk](mailto:info@adremit.co.uk)

### Our Address

Puravent, Adremit Limited, Unit 5a, Commercial Yard,  
Settle, North Yorkshire, BD24 9RH

# 1 - Generic information

## 1.1 Receiving the equipment

When the package is delivered, the customer is obliged to control the integrity of the packaging and the contents inside.

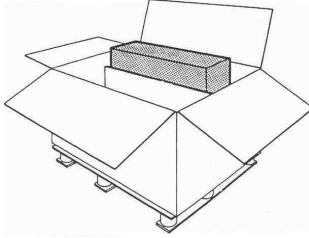

*Check the package and its contents, in case of damage due to the transport, the customer has to tick the damage claim box on the transport document counter signed by the carrier and send a copy of it to the supplier.*

## 1.2 Storing

- During transport and storage the temperature must be between -10°C and +50 °C.
- If the Eliturbo® units need to be stored the relative humidity of the storage must not be higher than 90%.

## 1.3 Unpacking



- Take the Eliturbo® units to the installation site.
- Take out the products from their packaging and collect all packaging materials to prevent danger of fire or choking for people and animals

## 1.4 Handling and transport

- Pay high attention when handling the Eliturbo® units during the phases of: downloading from the transport carrier, handling and positioning, to avoid doing damages to the product.
- Handle Eliturbo® units with maximum care and avoid to interfere with the fan blades.
- Handle the Eliturbo® air mixer by the top motor supports avoiding to interfere with the circular deflectors.
- Avoid touching the fan blades: danger deforming it and consequently unbalancing of the air mixer when switched on.



### Get In Touch

 Call: [0845 6880112](tel:08456880112)  
 Email: [info@adremit.co.uk](mailto:info@adremit.co.uk)

### Our Address

Puravent, Adremit Limited, Unit 5a, Commercial Yard,  
Settle, North Yorkshire, BD24 9RH

## 2 - Technical information

### 2.1 Technical characteristics

Eliturbo® E.L.C. series	ERP 2009/125 EU Reg. 206/2012		2000	2002
<b>Technical data</b>				
Absorbed power	P	W	220	310
Electrical supply		V	230V-1_50Hz / 400V-3_50Hz	
Fan type			Ceiling air mixer	
Motor protection grade		IP	54/55	
Blade version		n. of blades	2	4
Total air movement*		m <sup>3</sup> /h	7500	10000
Fan speed		RPM	700	700
Fan flow rate	F	m3/min	82	110
Operating values	SV	(m3/min)/W	0.37	0.35
Stand-by electrical consumption	P <sub>SB</sub>	W	NA	NA
Average air velocity	C	meters/sec	0.64	0.86
Sound power level	LwA	db(A)	62.5	64.1
<b>Dimensions</b>				
Diameter	∅	mm	680	
Height	h	mm	570	
Weight		kg	16	18
External finishing			Epoxy powder paint	
Ref.			IEC609879 – EN ISO1680	

\* treated air + induced air

### 2.2 Product use

Eliturbo® can be installed under the roof in any building where it is necessary to have ventilation, air mixing etc... for example:

- ✓ Industrial and commercial buildings, warehouses;
- ✓ Livestock farms;
- ✓ Swimming pools, tennis courts and all other type of sport facilities;
- ✓ Greenhouses;
- ✓ Churches, libraries, museums, exhibition pavilions, etc.

### 2.3 Wrong use

The product can't be used for different uses than the ones stated in the paragraph 2.2 of this guide, moreover:

IT IS ABSOLUTELY FORBIDDEN TO INSTALL THE ELITURBO® AIR MIXER IN ENVIRONMENTS WITH DANGER OF EXPLOSION.

IT IS NOT SUGGESTED TO USE EITURBO UNITS IN CLOSED PREMISES WHERE THERE IS A HIGH CONCENTRATION OF HALOGEN VAPOUR, PAY PARTICULAR ATTENTION TO EVALUATE THE ENVIRONMENTS FOR: LAUNDRY, DRY CLENING, TYPOGRAPHY, COIFFURE, COSMETIC SALOON.

#### Get In Touch

Call: 0845 6880112  
Email: [info@adremit.co.uk](mailto:info@adremit.co.uk)

#### Our Address

Puravent, Adremit Limited, Unit 5a, Commercial Yard,  
Settle, North Yorkshire, BD24 9RH

## 3 - Installing

### 3.1 General warnings for the installation

Before proceeding with installing the Eliturbo® units, it is necessary to check if all the components have been unpacked and their integrity checked.

The installation and start up of the Eliturbo® units must be done by qualified personnel and complying with the laws in force in the Country where the units will be installed.

The Eliturbo® air mixers can be supplied with two different directions of rotation, this is identifiable by the arrow colour applied on the unit and on its package:



Clockwise rotation



Counter clockwise rotation

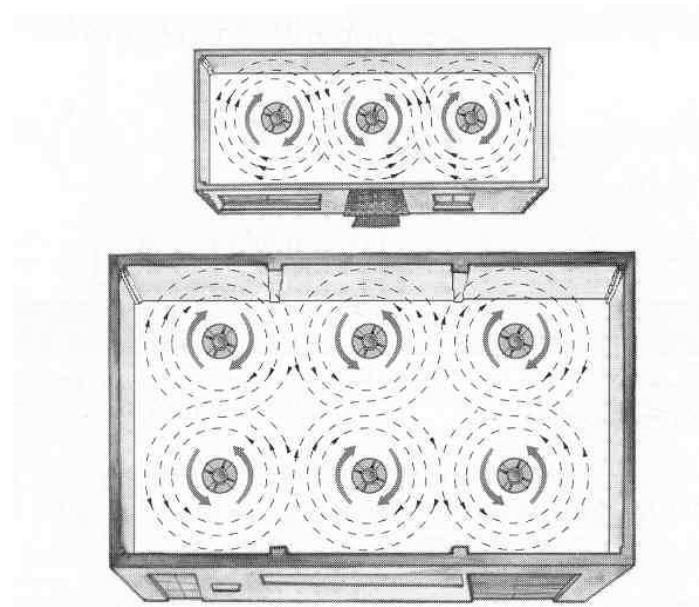

The choice the first unit's rotation is not important as long as the following units are installed with alternate rotations; it is not important what rotation the last unit has.

### 3.2 Installing the Eliturbo® air mixer

Before installing the units, verify that the position they should be installed they will not interfere with the operating of existing machinery as lifters, cranes etc.

Avoid positioning the unit near scaffolding, racks, etc..



In case of installation near an accessible mezzanine, check that the unit is installed at least 2,5m far from the mezzanine.

It is suggested to anchor the Eliturbo® units to the ceiling or to a beam, at a minimum distance from them of at least 15% of the entire height of the building but in any case not less than one meter.

For example:

Ceiling height (meters)	Installation height (meters)
6	5
8	$6,5 \div 7$
10	$8 \div 8,5$

#### Get In Touch

 Call: 0845 6880112  
 Email: [info@adremit.co.uk](mailto:info@adremit.co.uk)

#### Our Address

Puravent, Adremit Limited, Unit 5a, Commercial Yard,  
Settle, North Yorkshire, BD24 9RH

To anchor the unit to the ceiling use steel chains with a minimum diameter of the wire of 3.5 mm or use steel cables with minimum diameter of 4.0 mm

For a quick installation it is suggested to use chains.

The anchor points have to be at a sufficient distance to contrast the starting torque; it is suggested to position the anchoring points so that the chains will have an angle of 30° to 40° from the vertical line.

The length of the hanging device has to be long enough to grant a distance of at least one meter between the anchor point and the Eliturbo®'s motor.

The hanging devices have to support a weight equivalent to 10 times the weight of the unit distributed on the anchor points chosen (at least 100 Kg for each anchor point: with two anchor points).

**The Eliturbo® air mixer does not have to be installed at less than 2,5 m distance from the floor.**

Make sure that each air mixer is perfectly horizontal at the end of its installation.



#### Get In Touch

 Call: [0845 6880112](tel:08456880112)  
 Email: [info@adremit.co.uk](mailto:info@adremit.co.uk)

#### Our Address

Puravent, Adremit Limited, Unit 5a, Commercial Yard,  
Settle, North Yorkshire, BD24 9RH

### 3.3 Electrical connections

The connection to the electric network must be done by qualified personnel.  
The electrical cabling and connections must be made complying to the norms.

#### Electrical supply:

- 230 V 1~ 50 Hz for units with single phase motor
- 400 V 3 ~ 50 Hz for units with three phase motors

Between each Eliturbo® air mixer and the electric network insert an omnipolar switch, with a contact gap of at least 3 mm between each pole, easily reachable by the end user.

All motors must be protected with a motor protector switch calibrated at a voltage of 1,1 | 1,15 times the voltage indicated on the data plate.

If a switchboard or speed controller is installed then follow the switchboard/speed controller's own instructions.

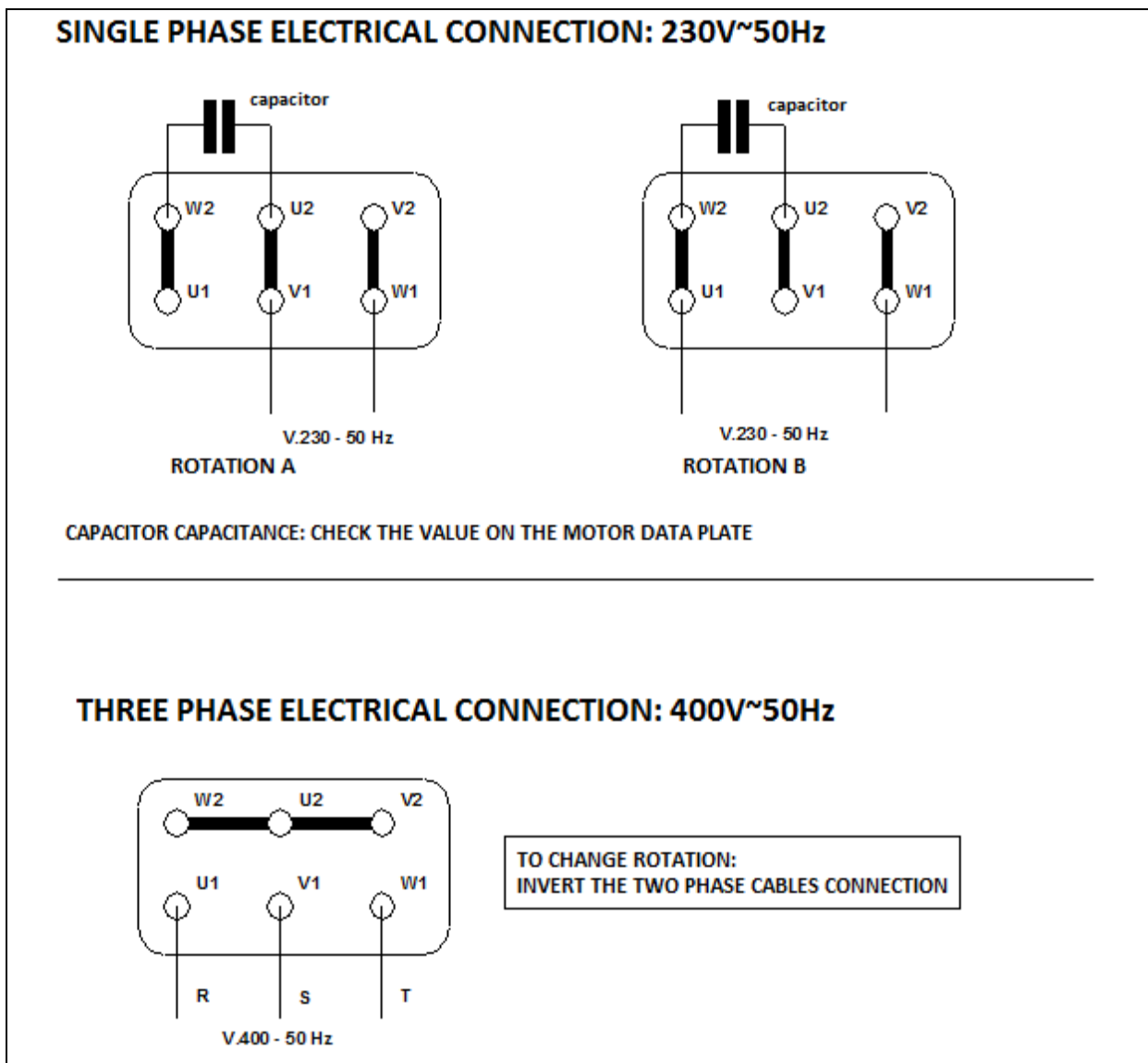

#### Get In Touch

Call: 0845 6880112  
Email: [info@adremit.co.uk](mailto:info@adremit.co.uk)

#### Our Address

Puravent, Adremit Limited, Unit 5a, Commercial Yard,  
Settle, North Yorkshire, BD24 9RH



### 3.4 Start up

Before switching on the Eliturbo® air mixer check that the hanging devices (chains, fischers, etc.) are correctly fixed, the product is perpendicular to the vertical line and that the electrical cables don't interfere with the movement of the blades.

Start the Eliturbo® air mixer and check the following:

- the rotation of the blades corresponds to the arrow indication on the product (see paragraph 3.1)
- that there are no strange noises: if there are strange noises then switch off immediately the Eliturbo® air mixer by interrupting the electric power supply to the product and find out what causes the noise
- the product does not have an excessive vibration due to the unbalance of the blades: if the vibration is excessive switch off immediately the Eliturbo® air mixer by interrupting the electric power supply to the product and contact the Technical Assistance of Impresind Srl
- in any case do not start up the product if any of the above signs are clearly showing

To change rotation to the motor, in case the blade is not rotating in the direction of the arrow on the product, first cut off electrical power to the Eliturbo® air mixer and then follow these steps:

- Single phase motor: connect the terminals as indicated in the electrical scheme on the product
- Three phase motor: exchange the two phases (example R-S)

## 4 - Risks

**Be careful of the fan blades when moving. Never insert limbs in the product: mechanical danger**  
**It is forbidden to use liquid substances to clean the product: electrocution danger**

## 5 - Emergency situations

In case of emergency:

- 
- Switch off immediately the motor and open the electric circuit using the omnipolar switch
- Identify and fix the problem by analysing the causes
- Contact the Technical Assistance service
- IT IS ABSOLUTELY FORBIDDEN TO USE WATER TO EXTINGUISH A FIRE ON THE PRODUCT

## 6 - Use



### 6.1 Switch on and off

Switch on and off the product using the omnipolar switch or the speed controller installed, it is possible to add (at end user's care) a clock switch that can manage automatically the time to switch on and off the product.

### 6.2 Suggested use

Switch on the Eliturbo® air mixers 15 to 30 minutes before the heating system switches on. Switch off the Eliturbo® air mixers 15 to 30 minutes after the heating system switches off, possibly evaluate to bring forward the switching off time of the heating system.

#### Get In Touch

 **Call:** 0845 6880112  
 **Email:** [info@adremit.co.uk](mailto:info@adremit.co.uk)

#### Our Address

Puravent, Adremit Limited, Unit 5a, Commercial Yard,  
Settle, North Yorkshire, BD24 9RH



Do not apply a room thermostat to command the Eliturbo® air mixer.

The Eliturbo® air mixer has to function constantly to contrast the natural stratification of hot air towards the ceiling.

For better management of the system and to achieve energy savings it is necessary that the heating system is commanded by a room thermostat positioned at 1,5 meters of height from the floor.

### 6.3 End of season switch off

At the end of the heating season, the system can be stopped by cutting off the electric tension with the general switch.

## 7 - Maintenance

Before the beginning of the heating season it is necessary to check that the products work properly, so that in case of problems there is time to intervene with maintenance or repairs.

Check once a year:

- the electric network safety, absorption and dissipation
- that the Eliturbo® air mixer are well anchored to the ceiling or beam (chains, fischer plugs etc...)
- stability and balancing of the fan blades: no big vibrations have to be detected
- cleanliness of the fan's blades (in dusty or humid environments deposits on the fan blades can make them heavier obliging the engine to work excessively)
- general cleanliness of the Eliturbo® air mixer.

Use cleaning products that do not damage the Eliturbo® air mixer materials and electrical cabling.

## 8 - Dismantling

Dismantling the system must to be done by specialised personnel by using correct tools and personal protection devices.

In case of dismantling or discontinuation of the system, it is necessary to collect all the materials and dispose of them to the respective disposal centres, if possible by contacting disposal specialised companies.

The Products are compliant to the following European Directives:

2006/42/EC Machinery Directive-(MD)

2006/95/EC Low Voltage Directive-(LVD)

2004/108/EC Electromagnetic Compatibility Directive-(EMC)

2009/125/EC Energy-Related Products directive-(ERP)\*

\*Implemented by the Commission Regulation No 206/2012

### Get In Touch

 **Call:** 0845 6880112  
 **Email:** [info@adremit.co.uk](mailto:info@adremit.co.uk)

### Our Address

Puravent, Adremit Limited, Unit 5a, Commercial Yard,  
Settle, North Yorkshire, BD24 9RH