

HELLA

Linear Slot Diffuser

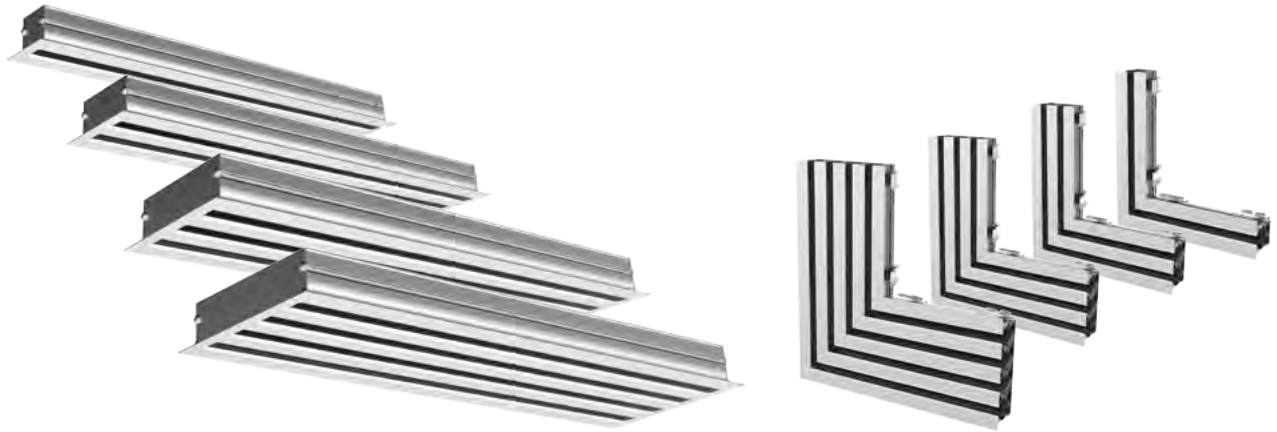



Table of Content

Description	2
Design	3
Dimensions	4
Ordering Codes	6
Accessories	8
Technical Parameters	13
Installation, Maintenance & Operation	20
Transport & Storage	20
Supplement	20
Related Products	21



Get In Touch

 **Call:** [0845 6880112](tel:08456880112)
 **Email:** info@adremit.co.uk

Our Address

Puravent, Adremit Limited, Unit 5a, Commercial Yard,
 Settle, North Yorkshire, BD24 9RH

Description

HELLA is a linear slot diffuser, mainly intended for air supply in comfort ventilation systems for offices, shops, medical rooms, school classrooms etc.

The supply air flow pattern/direction can be formed by adjustable deflectors in vents, air flow volume can be tuned by slider adjustment damper. Air extract is also possible with HELLA.

Typical installation location for HELLA is suspended ceiling. The diffusers can be installed as individual pieces or in array of multiple segments.

Highlights

- Modern slim and compact design
- Easy and quick installation
- Precise adjustment of air discharge pattern
- Installation with or without plenum box
- Plenum box with tightness class C, compliant with EN 1751 standard
- Slider adjustment damper available
- Individual diffuser or continuous array of multiple diffusers installable
- 1-, 2-, 3- or 4-slot arrangement
- Rectangular corner elements available

Product Types

- HELLA: Linear diffuser
- HELLA-T: Linear diffuser for T-bar ceiling installation
- HELLA-CE: 90° corner element

Information about accessories for HELLA is available from page 8

- PB-HELLA: Plenum box
- MB-HELLA: Mounting bridge
- CP-HELLA: Connection piece
- EC-HELLA: End-cap

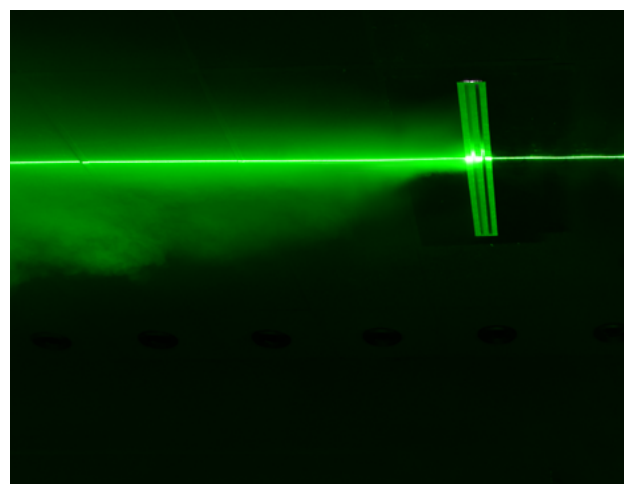
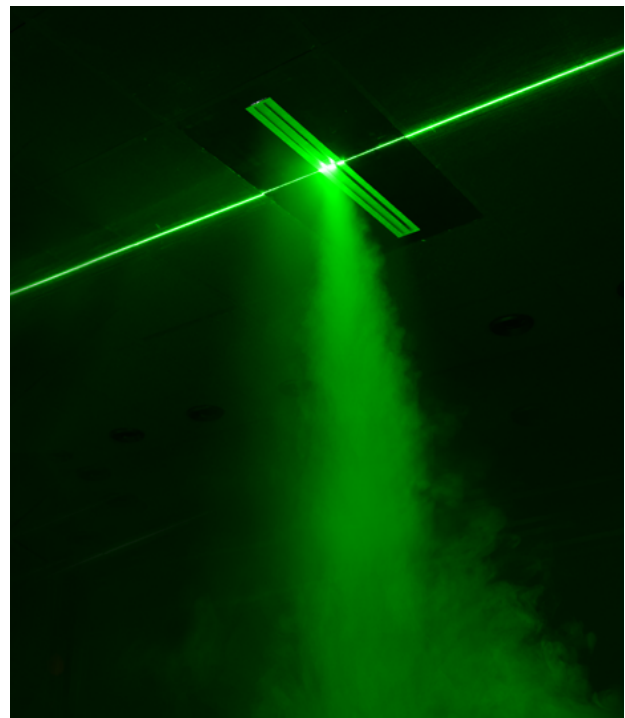

Fig. 1: Air flow visualisation

Get In Touch

-  Call: [0845 6880112](tel:08456880112)
 Email: info@adremit.co.uk

Our Address

Puravent, Adremit Limited, Unit 5a, Commercial Yard,
Settle, North Yorkshire, BD24 9RH

Design

Linear slot diffuser HELLA is manufactured from aluminium profiles. The surface treatment can be anodized aluminium or powder paint.

The number of slots can be 1 up to 4.

Each individual slot is equipped by longitudinal deflector, which can be adjusted for different air flow patterns in 180° angle between the vertical and two opposed horizontal directions.

These deflectors as well as the profiles dividing the slots are dismantlable without tools, making so the installation of the diffuser easy. The galvanized steel slider adjustment damper as a part of the diffuser can be attached or detached without tools. The end caps (frame profiles on short sides of the diffuser) are fixed by screws. If the end caps are dismantled, it is possible to install a continuous array of multiple diffusers. Galvanized steel plenum box with circular duct connection can be delivered as accessory of the diffuser optionally with insulation inside/outside. For installation without plenum box a galvanized steel mounting bridge is available.

Product Parts & Setup Possibilities

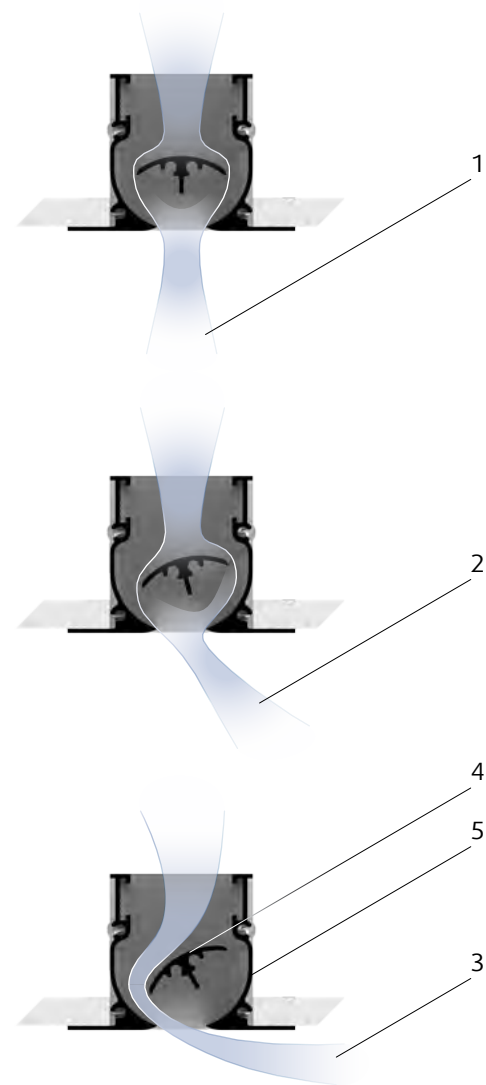

Fig. 2: Different deflectors setup and resulting air flow patterns

Legend

1	Vertical distribution; position 1
2	Diagonal distribution; positions 2
3	Horizontal distribution; positions 3
4	Deflector
5	Diffuser

Get In Touch

Call: [0845 6880112](tel:08456880112)
 Email: info@adremit.co.uk

Our Address

Puravent, Adremit Limited, Unit 5a, Commercial Yard,
 Settle, North Yorkshire, BD24 9RH

Dimensions

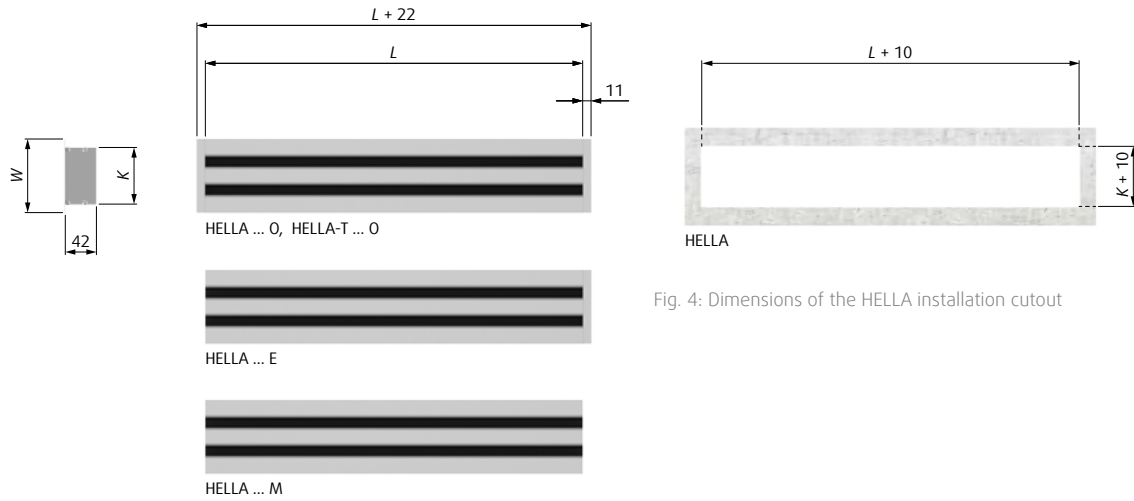

Fig. 4: Dimensions of the HELLA installation cutout

Fig. 3: Dimensions of HELLA and HELLA-T

Tab. 1: Dimensions and weights of the HELLA

L	HELLA-1			HELLA-2			HELLA-3			HELLA-4		
	W	K	m	W	K	m	W	K	m	W	K	m
(mm)			(kg)	(mm)			(kg)	(mm)			(kg)	
500	60	41	0,7	97	77	1,0	134	114	1,4	171	151	1,8
600			0,8			1,2			1,6			2,1
700			0,9			1,4			1,9			2,4
800			1,0			1,6			2,2			2,7
900			1,1			1,7			2,4			3,0
1000			1,2			1,9			2,6			3,3
1100			1,3			2,1			2,9			3,6
1200			1,4			2,3			3,1			3,9
1300			1,5			2,5			3,4			4,2
1400			1,6			2,7			3,6			4,6
1500	1,8	2,8	3,8	4,8								

Tab. 2: Dimensions and weights of the HELLA-T

L _t	L	HELLA-T-1			HELLA-T-2			HELLA-T-3			HELLA-T-4		
		W	K	m	W	K	m	W	K	m	W	K	m
(mm)			(kg)	(mm)			(kg)	(mm)			(kg)		
600	573	60	41	0,7	97	77	1,2	134	114	1,6	171	151	2,0
1200	1173			1,3			2,2			3,0			3,8
1800	1773			2,2			3,5			4,7			6,0
2400	2373			2,8			4,6			6,2			7,8

NOTE: L_t is a nominal length.



Get In Touch

Call: 0845 6880112
 Email: info@adremit.co.uk

Our Address

Puravent, Adremit Limited, Unit 5a, Commercial Yard, Settle, North Yorkshire, BD24 9RH



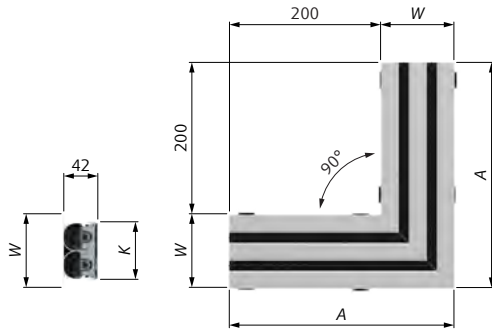

Fig. 5: Dimensions of the HELLA-CE

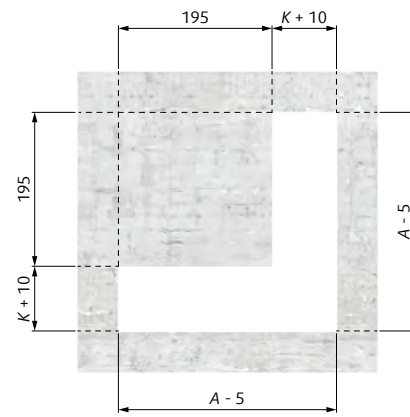

Fig. 6: Dimensions of the HELLA-CE installation cutout

Tab. 3: Dimensions and weights of the HELLA-CE

HELLA-CE-1				HELLA-CE-2				HELLA-CE-3				HELLA-CE-4			
A	W	K	m	A	W	K	m	A	W	K	m	A	W	K	m
(mm)			(kg)	(mm)			(kg)	(mm)			(kg)	(mm)			(kg)
260	60	41	0,8	297	97	77	1,2	334	134	114	1,7	371	171	151	2,3

Get In Touch

Call: [0845 6880112](tel:08456880112)
 Email: info@adremit.co.uk

Our Address

Puravent, Adremit Limited, Unit 5a, Commercial Yard,
 Settle, North Yorkshire, BD24 9RH

Ordering Codes

HELLA

Linear Diffuser

		HELLA -	
Number of slots		1 ... 4	
Diffuser length L (mm) ¹⁾	Increment 100 mm	500 ... 1500	
Deflector colour	Black	B	
	White (extra charge)	W	
Damper	Slider adjustment damper	R	
	No damper	O	
Diffuser construction	Complete unit including end caps at both ends ²⁾	O	
	End unit for linear assembly	E	
	Middle unit for linear assembly	M	
Surface finish	Anodized aluminium finish	AN	
	Powder coating - white, 30% gloss	W	
	Powder coating - other RAL colours	RALxxxx	

NOTES:

- 1) Standard sizes for non-specific installation.
L represents the length of the diffuser part immersed in the ceiling.
- 2) End cap is the detachable short side of the frame on HELLA diffuser (see page 16).

Example of the Ordering Code

HELLA-2-1500-B-0-0-AN

Diffuser with 2 slots, 1500 mm length, black deflectors, without damper, complete unit including side frame at both ends, anodized aluminium finish.

Get In Touch

Call: [0845 6880112](tel:08456880112)
 Email: info@adremit.co.uk

Our Address

Puravent, Adremit Limited, Unit 5a, Commercial Yard,
Settle, North Yorkshire, BD24 9RH

HELLA-T

Linear Diffuser for T-bar Ceiling Installation

		HELLA-T -	
Number of slots		1 ... 4	
Nominal length L_1 (mm) ¹⁾		600	
		1200	
		1800	
		2400	
Deflector colour	Black	B	
	White (extra charge)	W	
Damper	Slider adjustment damper	R	
	No damper	0	
Surface finish	Anodized aluminium finish	AN	
	Powder coating - white, 30% gloss	W	
	Powder coating - other RAL colours	RALxxxx	

NOTES:

1) Sizes for installation in T-bar ceiling, raster 600 mm.

L_1 represents the length of the diffuser outer frame laid on the ceiling T-profiles.

Example of the Ordering Code

HELLA-T-2-1200-B-0-AN

Diffuser for T-bar raster 600 mm, with 2 slots, length of diffuser 1200 mm, black deflectors, without damper, anodized aluminium finish.

HELLA-CE

90° Corner Element

		HELLA-CE -	
Number of slots		1 ... 4	
Deflector colour	Black	B	
	White (extra charge)	W	
Surface finish	Anodized aluminium finish	AN	
	Powder coating - white, 30% gloss	W	
	Powder coating - other RAL colours	RALxxxx	

NOTES:

HELLA-CE is a corner element with only visual function. It cannot be used for air distribution.

HELLA-CE is delivered with 4 pieces of mounting bridges MB-HELLA in corresponding size.

Example of the Ordering Code

HELLA-CE-3-B-AN

Corner element, with 3 slots, black deflectors, anodized aluminium finish.

Get In Touch

Call: [0845 6880112](tel:08456880112)
 Email: info@adremit.co.uk

Our Address

Puravent, Adremit Limited, Unit 5a, Commercial Yard,
 Settle, North Yorkshire, BD24 9RH

Accessories

PB-HELLA & PB-HELLA-T

Plenum Boxes

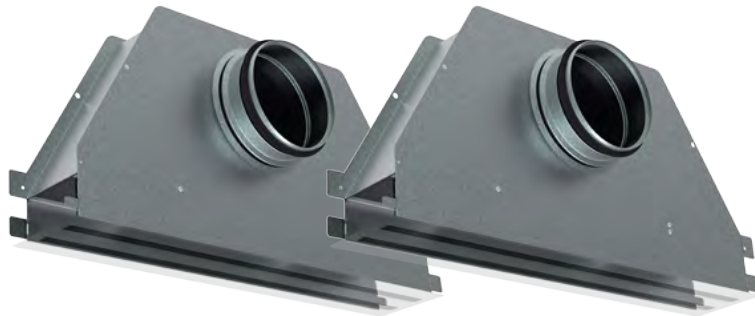

Description

Plenum boxes PB-HELLA and PB-HELLA-T are used to achieve proper discharge parameters of diffusers HELLA and HELLA-T, corresponding in size and number of slots.

Design

PB-HELLA and PB-HELLA-T is made from galvanized steel sheet, equipped by circular duct connections with rubber gasket. The box can have isolation inside and outside. Tightness class of the plenum box is "C" in compliance with EN 1751 standard.

Multiple boxes can be installed with multiple diffusers arranged in an array. For this type of installation the boxes have connecting ears to join with neighbouring box.

For diffusers HELLA-T of length 1800 mm and 2400 mm the plenum boxes PB-HELLA-T with corresponding length consist from two connected plenum box segments with two separate air inlets (see dimension table PB-HELLA-T).

Get In Touch

 Call: [0845 6880112](tel:08456880112)
 Email: info@adremit.co.uk

Our Address

Puravent, Adremit Limited, Unit 5a, Commercial Yard,
Settle, North Yorkshire, BD24 9RH

Dimensions

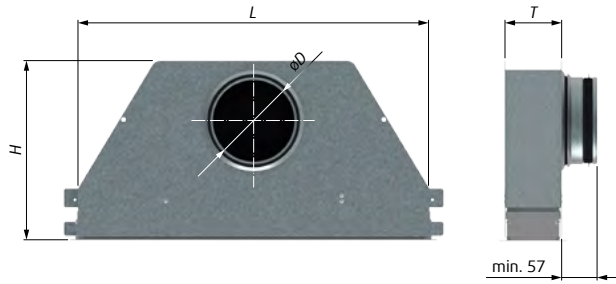

Fig. 7: Dimensions of the PB-HELLA and PB-HELLA-T

Tab. 5: Dimensions of the PB-HELLA

		PB-HELLA-1										
L	(mm)	500	600	700	800	900	1000	1100	1200	1300	1400	1500
H	(mm)	214										
T	(mm)	44										
øD	(mm)	100					125					
m	(kg)	1,3	1,5	1,7	1,9	2,1	2,3	2,5	2,8	3,0	3,2	3,4

		PB-HELLA-3										
L	(mm)	500	600	700	800	900	1000	1100	1200	1300	1400	1500
H	(mm)	282										
T	(mm)	118										
øD	(mm)	160					200					
m	(kg)	1,9	2,2	2,4	2,7	2,9	3,3	3,5	3,8	4,1	4,3	4,6

		PB-HELLA-2										
L	(mm)	500	600	700	800	900	1000	1100	1200	1300	1400	1500
H	(mm)	250										
T	(mm)	81										
øD	(mm)	125					160					
m	(kg)	1,6	1,8	2,0	2,3	2,5	2,8	3,0	3,3	3,5	3,7	4,0

		PB-HELLA-4										
L	(mm)	500	600	700	800	900	1000	1100	1200	1300	1400	1500
H	(mm)	337										
T	(mm)	155										
øD	(mm)	200					250					
m	(kg)	2,4	2,7	2,9	3,2	3,5	3,9	4,2	4,5	4,8	5,1	5,4

NOTE: The external isolation J (see the Ordering code on previous page) increases the dimension T by approximately 2 × 6 mm.

Tab. 4: Dimensions of the PB-HELLA-T

		PB-HELLA-T-1				PB-HELLA-T-2				PB-HELLA-T-3				PB-HELLA-T-4			
L _t	(mm)	600	1200	1800	2400	600	1200	1800	2400	600	1200	1800	2400	600	1200	1800	2400
n		1		2		1		2		1		2		1		2	
L	(mm)	573	1173	1773	2373	573	1173	1773	2373	573	1173	1773	2373	573	1173	1773	2373
H	(mm)	214				250				282				337			
T	(mm)	44				81				118				155			
øD	(mm)	100				125				160				200			
m	(kg)	1,5	2,8	4,2	5,6	1,6	3,3	5	6,6	1,9	3,8	5,8	7,6	2,4	4,5	7	9

NOTES:

L_t = Nominal length of diffuser HELLA-T

n = Number of plenum box segments

L, H, T = Physical dimensions of plenum box PB-HELLA-T. See the Dimensions picture on previous page.

The external isolation J (see the Ordering code on page 13) increases the dimension T by approximately 2 × 6 mm.

For sizes 1800 and 2400 L is overall length of both plenum box segments together.

The weight m (kg) is stated for the whole plenum box set regardless if it consists of one or two plenum box segments.

Get In Touch

Call: 0845 6880112
 Email: info@adremit.co.uk

Our Address

Puravent, Adremit Limited, Unit 5a, Commercial Yard, Settle, North Yorkshire, BD24 9RH

Ordering Codes

PB-HELLA

Plenum Box for HELLA Diffuser

		PB-HELLA - 	
Number of slots on diffuser		1 ... 4	
Length	Increment 100 mm	500 ... 1500	
Isolation ¹⁾	Internal isolation	I1	
	External isolation	J	

NOTES:

1) The external isolation J increases the dimension T (see the Dimensions picture on following page) by approximately 2 × 6 mm.
If no isolation is defined, the plenum box will come without isolation.

Plenum box PB-HELLA and mounting bridge MB-HELLA exclude each other in use with the same diffuser HELLA

Example of the Ordering Code

PB-HELLA-2-1000-I2

Plenum box for double slot diffuser HELLA, 1000 mm length, internal isolation.

PB-HELLA-T

Plenum Box for HELLA-T Diffuser

		PB-HELLA-T - 	
Number of slots on diffuser		1 ... 4	
Length L_t ¹⁾		600	
	Nominal length of plenum box	1200	
		1800	
		2400	
Isolation ²⁾	Internal isolation	I1	
	External isolation	J	

NOTES:

1) Plenum box PB-HELLA-T...-600 is intended for diffuser HELLA-T...-600
Plenum box PB-HELLA-T...-1200 is intended for diffuser HELLA-T...-1200
Plenum box PB-HELLA-T...-1800, composed from 2 segments, is intended for diffuser HELLA-T...-1800
Plenum box PB-HELLA-T...-2400, composed from 2 segments, is intended for diffuser HELLA-T...-2400

2) The external isolation J increases the dimension T (see the Dimensions picture on following page) by approximately 2 × 6 mm.
If no isolation is defined, the plenum box will come without isolation.

Plenum box PB-HELLA-T and mounting bridge MB-HELLA exclude each other in use with the same diffuser HELLA-T.

Example of the Ordering Code

PB-HELLA-T-2-1800

Plenum box for double slot diffuser HELLA-T, 1800 mm length, no isolation.
The plenum box consists from 2 segments.

Get In Touch

 **Call:** 0845 6880112
 **Email:** info@adremit.co.uk

Our Address

Puravent, Adremit Limited, Unit 5a, Commercial Yard, Settle, North Yorkshire, BD24 9RH

MB-HELLA

Mounting Bridge

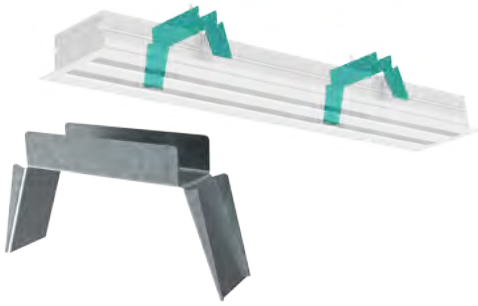

Description

The mounting bridge is used for installation of HELLA diffuser without plenum box in the suspended ceiling.

Design

MB-HELLA is made from galvanized steel. It has a rivet nut to catch the fixing thread bolt of the diffuser.

For each number of slots on diffuser HELLA a different size of MB-HELLA is dedicated. Each diffuser HELLA requires 2 pieces of MB-HELLA for installation.

Ordering Code

Number of slots on diffuser HELLA MB-HELLA -

NOTE: Mounting bridge MB-HELLA and plenum box PB-HELLA exclude each other in use with the same diffuser HELLA.

Example of the Ordering Code

MB-HELLA-2

Mounting bridge for double slot diffuser HELLA-2.

CP-HELLA

Connection pin



Description

CP-HELLA is a connecting pin for joining neighbouring diffusers HELLA in an array.

Design

Circular profile pin from galvanized steel. The pins are applied in the holes at the ends of the longitudinal frame profiles of the diffuser HELLA.

Other Specification

The quantity of CP-HELLA required to join multiple diffusers in an array: $p = 4 \cdot (n - 1)$

p = required quantity of CP-HELLA pins
 n = number of HELLA diffusers in the array

Ordering Code

CP-HELLA

Get In Touch

Call: [0845 6880112](tel:08456880112)
 Email: info@adremit.co.uk

Our Address

Puravent, Adremit Limited, Unit 5a, Commercial Yard, Settle, North Yorkshire, BD24 9RH

EC-HELLA

End-cap

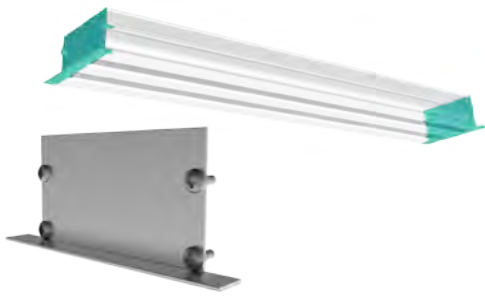

Description

The end caps on HELLA diffuser are part of the frame that covers the installation cut-out in ceiling when a single diffuser is installed. EC-HELLA shall be detached from diffuser when installed in array of multiple diffusers.

Design

EC-HELLA is made from aluminium profile with anodized or painted surface.

The end cap can be attached to the diffuser by screws, that are included in package of EC-HELLA.

Ordering Code

Number of slots on diffuser	EC-HELLA -	
	1 ... 4	
Surface finish ¹⁾	Anodized aluminium finish	AN
	Powder coating - white, 30% gloss	W
	Powder coating - other RAL colours	RALxxxx

NOTES:

1) If no Surface finish is defined, white powder coating will be delivered.

EC-HELLA is delivered with 4 pieces of screws.

Example of the Ordering Code

EC-HELLA-2-AN

End-cap for double slot diffuser HELLA, anodized aluminium finish.

Get In Touch

Call: [0845 6880112](tel:08456880112)
 Email: info@adremit.co.uk

Our Address

Puravent, Adremit Limited, Unit 5a, Commercial Yard, Settle, North Yorkshire, BD24 9RH

Technical Parameters

Legend

p_s	(Pa)	Pressure drop
q_v	(m ³ /h) (l/s)	Air flow volume
L_{WA}	(dB)	A-weighted sound power level
ΔT	(K)	Temperature difference Supply air - Room air
$L_{0,2}$	(m)	Air throw length with terminal velocity 0,2 m/s
L_x	(m)	Air throw length calculated for specific terminal velocity
x	(m/s)	Terminal velocity in range of (0,1 ÷ 1) m/s
1, 2, 3, 4		Diagram line for diffuser with 1, 2, 3 or 4 slots

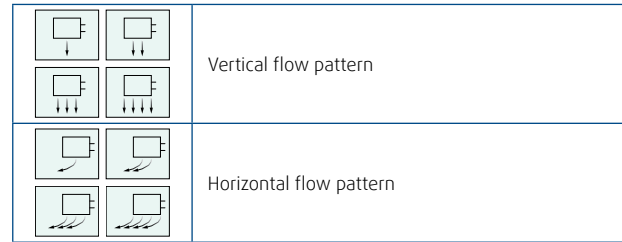

Calculation of Air Throw for Different Terminal Velocities

$$L_x = L_{0,2} \cdot 0,2/x$$

Get In Touch

Call: [0845 6880112](tel:08456880112)
 Email: info@adremit.co.uk

Our Address

Puravent, Adremit Limited, Unit 5a, Commercial Yard,
Settle, North Yorkshire, BD24 9RH

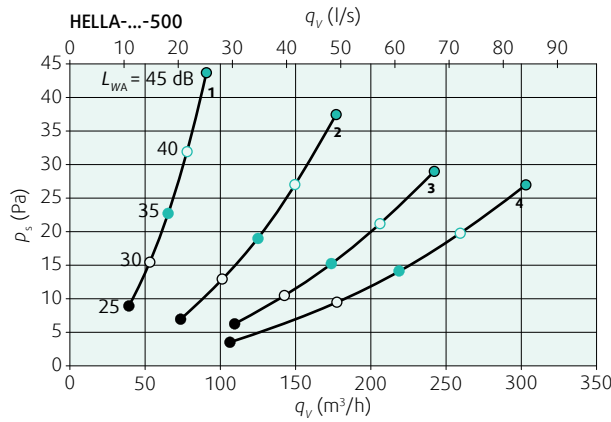

Diagram 1: Pressure drop & A-weighted sound power level; measured with PB-HELLA plenum box, without damper

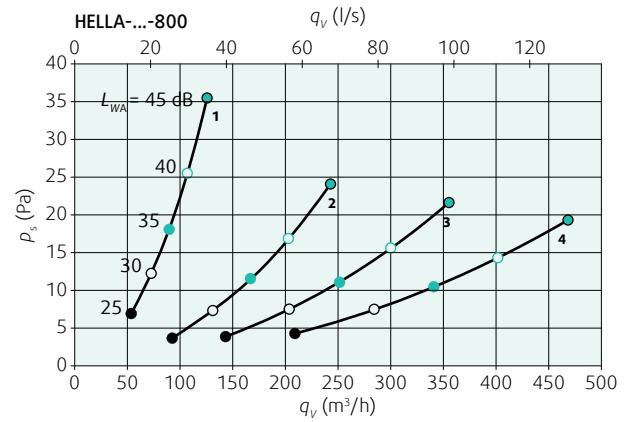

Diagram 4: Pressure drop & A-weighted sound power level; measured with PB-HELLA plenum box, without damper

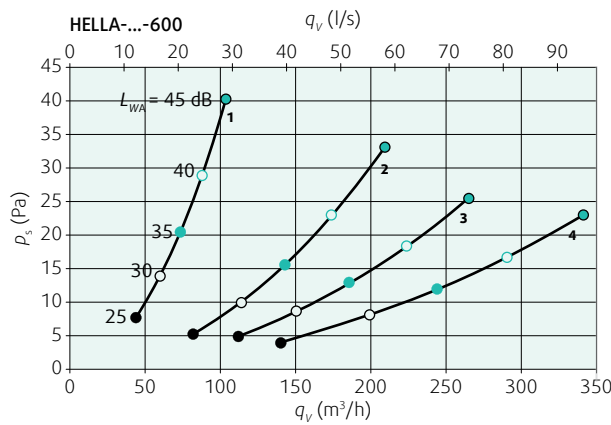

Diagram 2: Pressure drop & A-weighted sound power level; measured with PB-HELLA plenum box, without damper

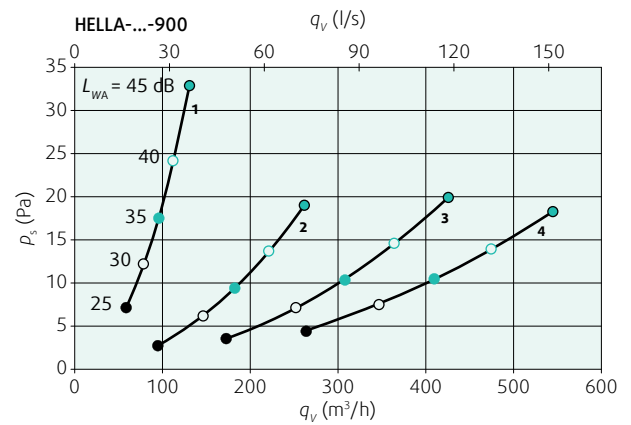

Diagram 5: Pressure drop & A-weighted sound power level; measured with PB-HELLA plenum box, without damper

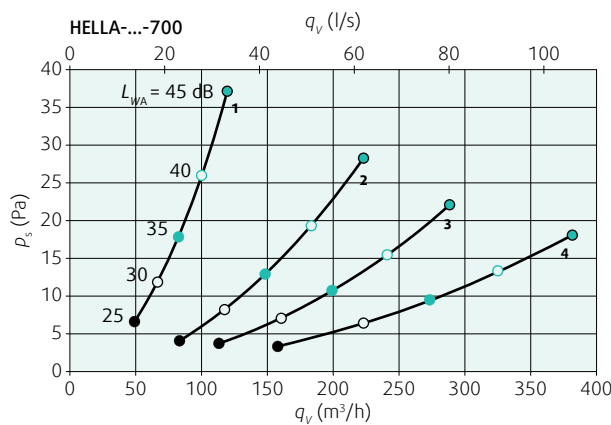

Diagram 3: Pressure drop & A-weighted sound power level; measured with PB-HELLA plenum box, without damper

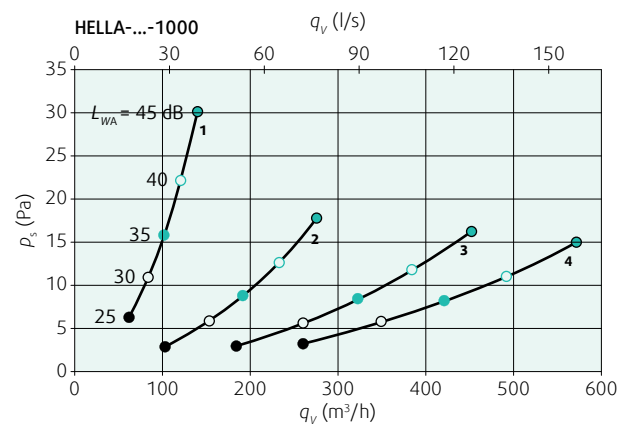

Diagram 6: Pressure drop & A-weighted sound power level; measured with PB-HELLA plenum box, without damper



Get In Touch

Call: 0845 6880112
 Email: info@adremit.co.uk

Our Address

Puravent, Adremit Limited, Unit 5a, Commercial Yard, Settle, North Yorkshire, BD24 9RH



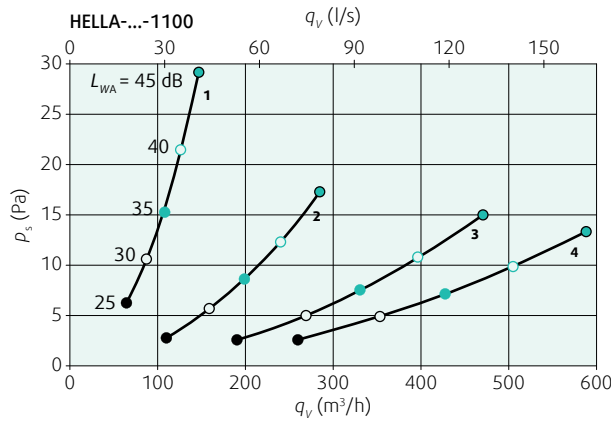

Diagram 7: Pressure drop & A-weighted sound power level; measured with PB-HELLA plenum box, without damper

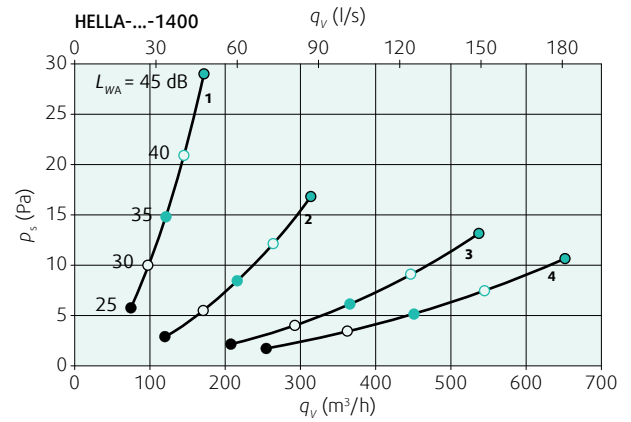

Diagram 10: Pressure drop & A-weighted sound power level; measured with PB-HELLA plenum box, without damper

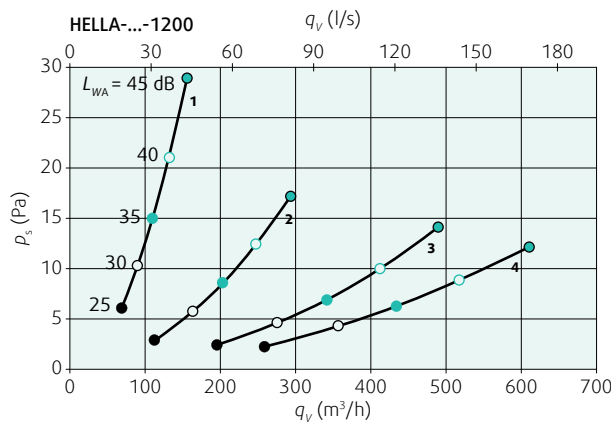

Diagram 8: Pressure drop & A-weighted sound power level; measured with PB-HELLA plenum box, without damper

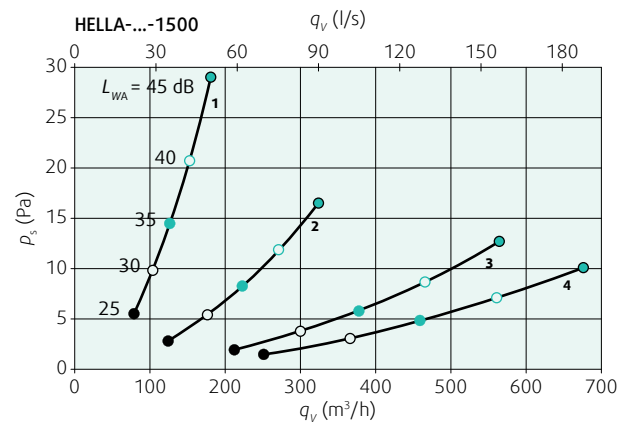

Diagram 11: Pressure drop & A-weighted sound power level; measured with PB-HELLA plenum box, without damper

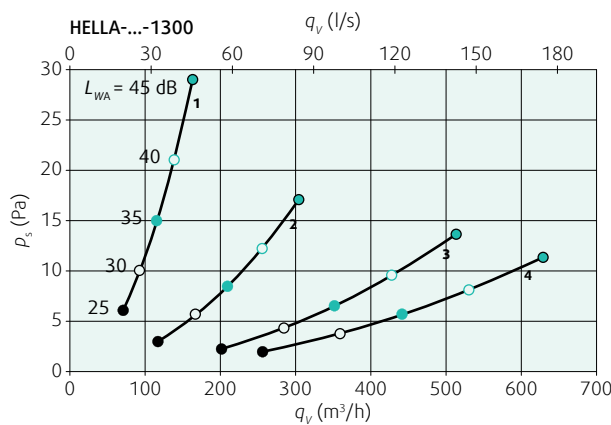

Diagram 9: Pressure drop & A-weighted sound power level; measured with PB-HELLA plenum box, without damper

Get In Touch

Call: 0845 6880112
 Email: info@adremit.co.uk

Our Address

Puravent, Adremit Limited, Unit 5a, Commercial Yard,
 Settle, North Yorkshire, BD24 9RH

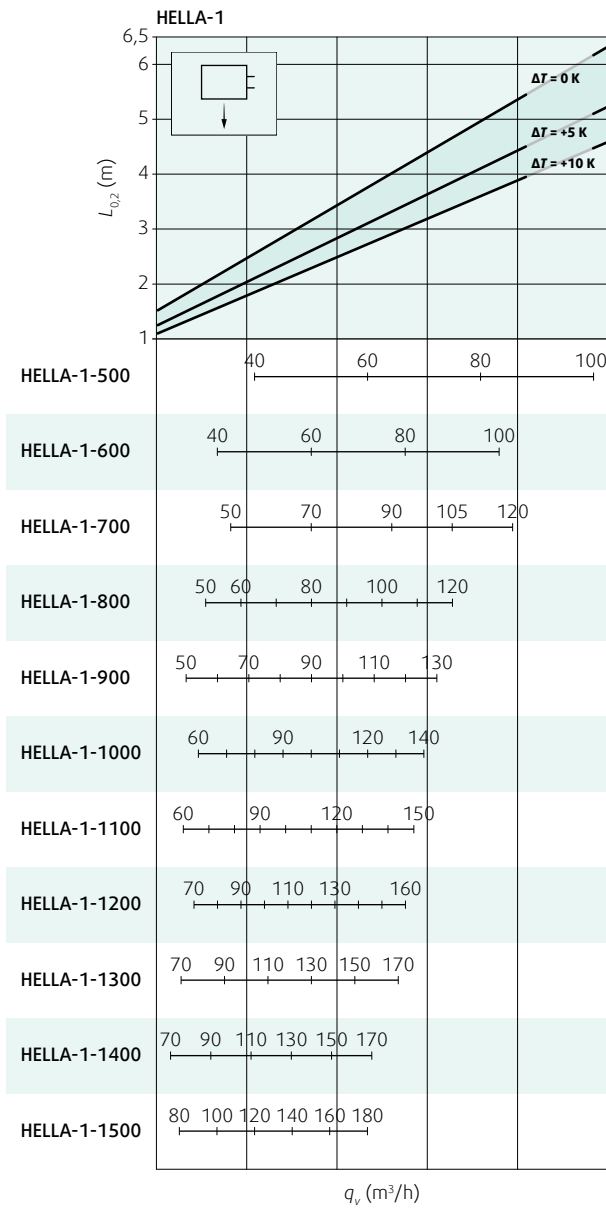

Diagram 12: Air throw length with terminal velocity 0,2 m/s (vertical flow pattern)

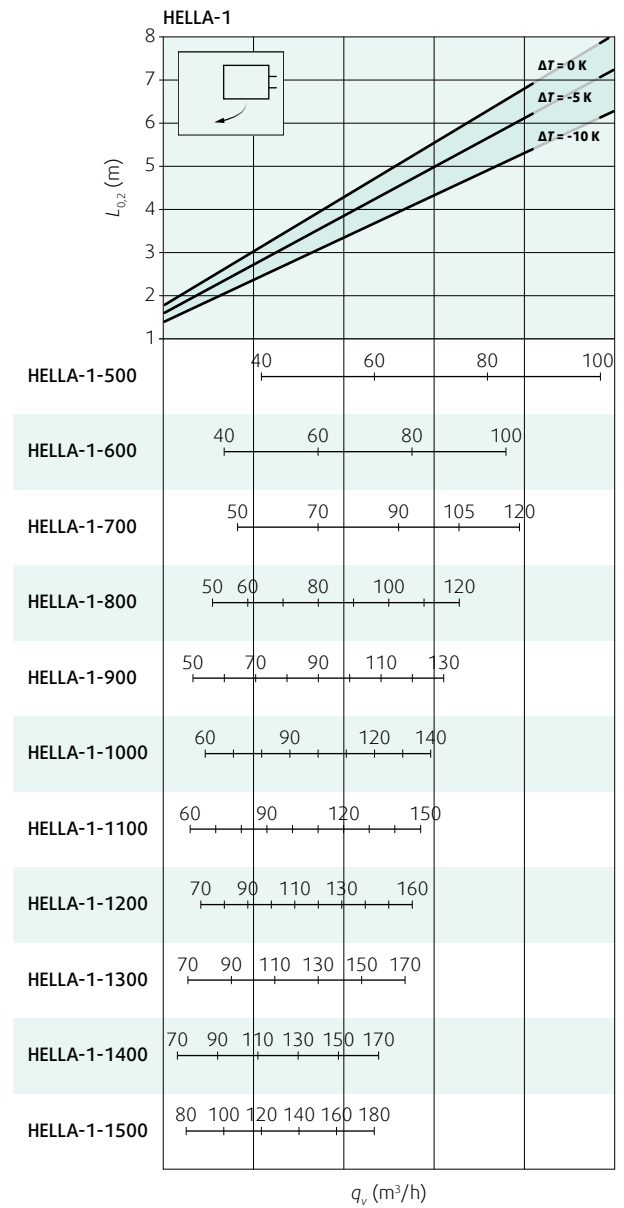

Diagram 13: Air throw length with terminal velocity 0,2 m/s (horizontal flow pattern)



Get In Touch

Call: 0845 6880112
 Email: info@adremit.co.uk

Our Address

Puravent, Adremit Limited, Unit 5a, Commercial Yard, Settle, North Yorkshire, BD24 9RH



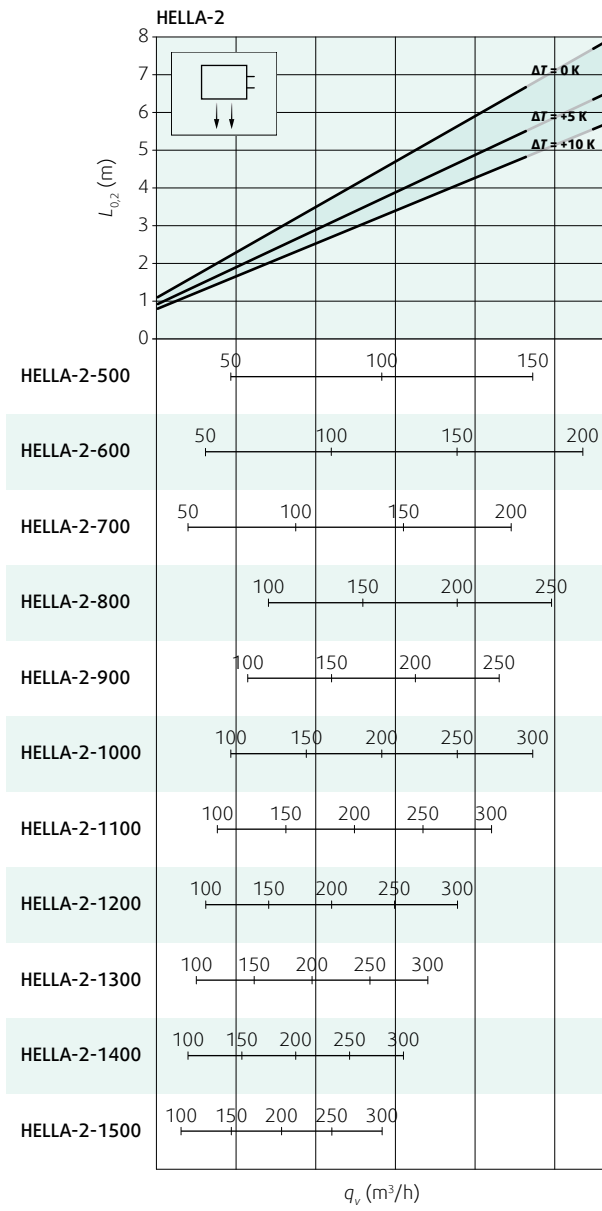

Diagram 14: Air throw length with terminal velocity 0,2 m/s (vertical flow pattern)

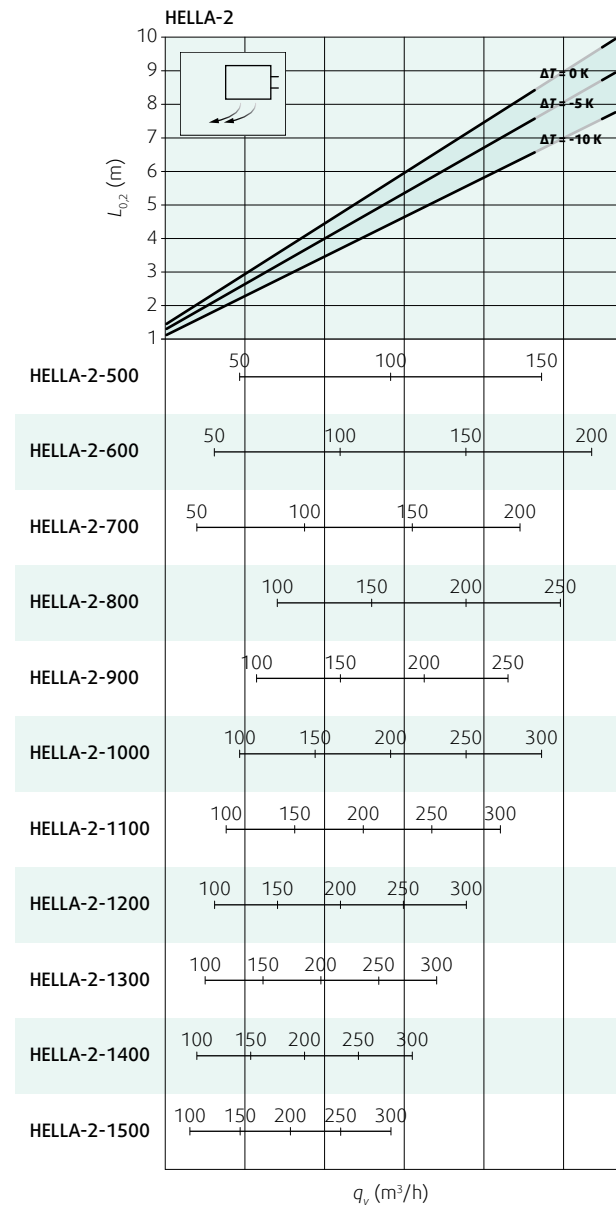

Diagram 15: Air throw length with terminal velocity 0,2 m/s (horizontal flow pattern)

Get In Touch

Call: 0845 6880112
 Email: info@adremit.co.uk

Our Address

Puravent, Adremit Limited, Unit 5a, Commercial Yard,
 Settle, North Yorkshire, BD24 9RH

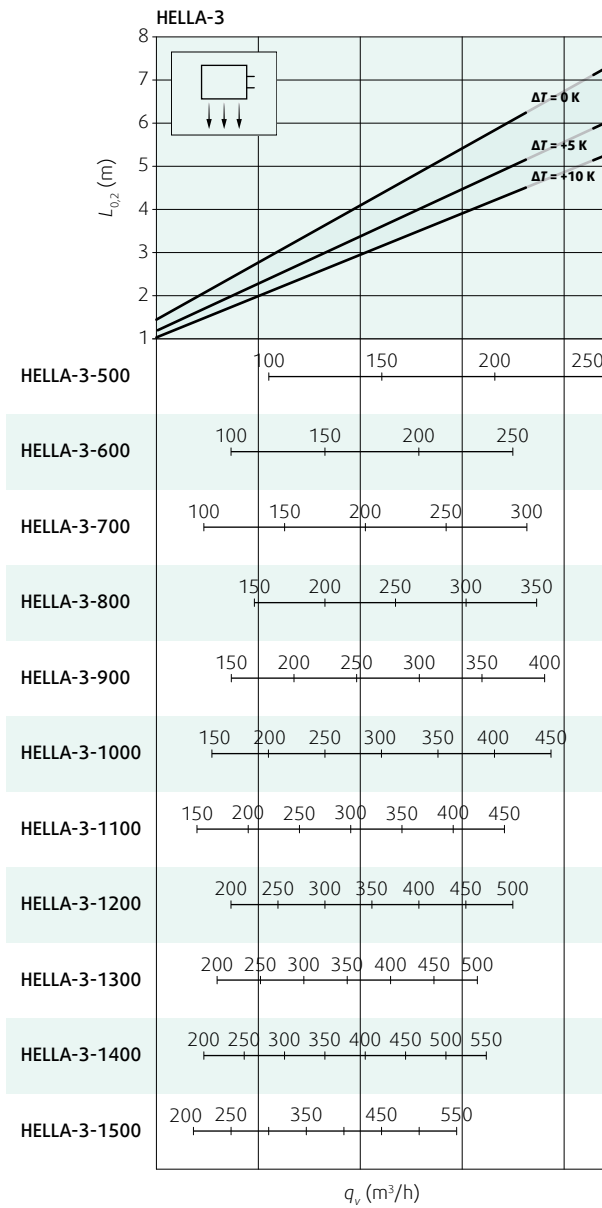

Diagram 16: Air throw length with terminal velocity 0,2 m/s (vertical flow pattern)

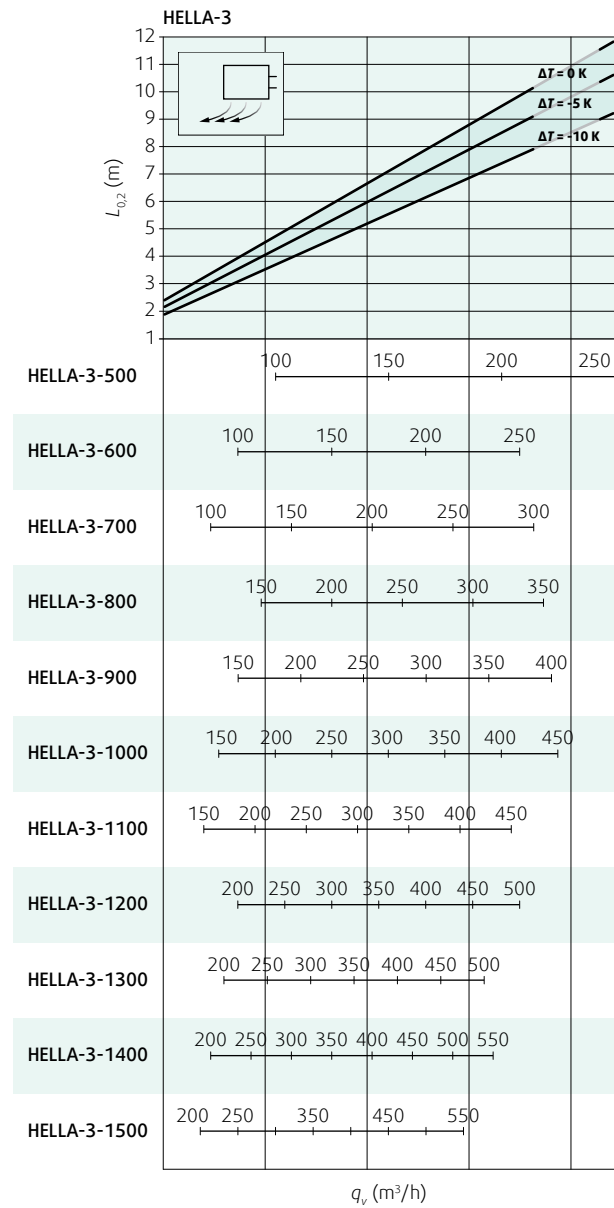

Diagram 17: Air throw length with terminal velocity 0,2 m/s (horizontal flow pattern)



Get In Touch

Call: 0845 6880112
 Email: info@adremit.co.uk

Our Address

Puravent, Adremit Limited, Unit 5a, Commercial Yard, Settle, North Yorkshire, BD24 9RH



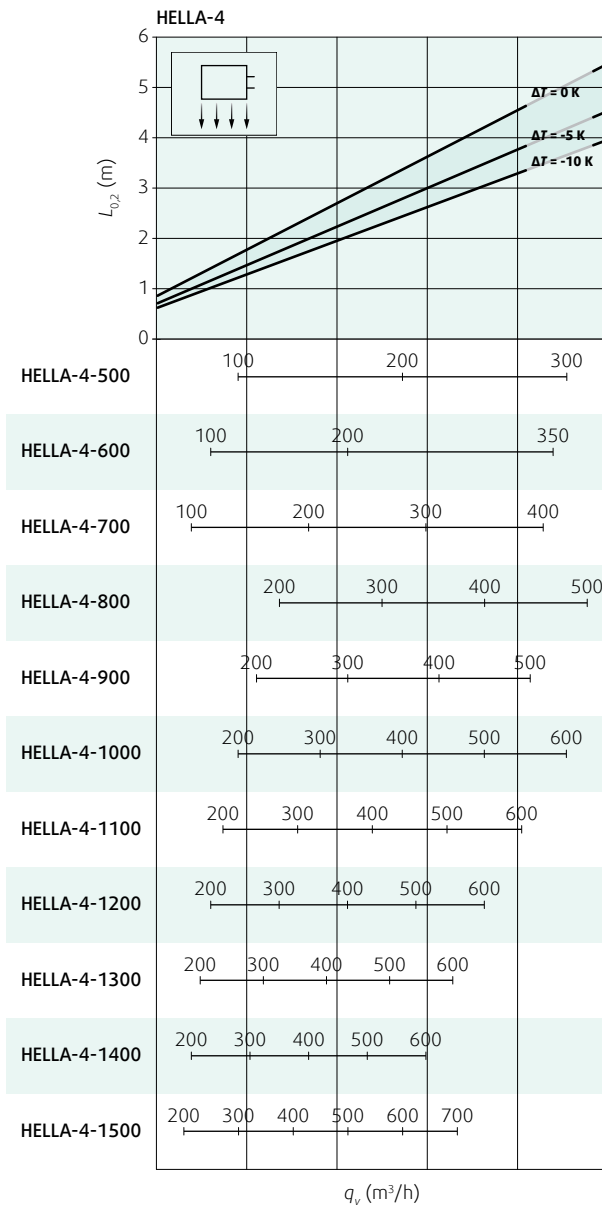

Diagram 18: Air throw length with terminal velocity 0,2 m/s (vertical flow pattern)

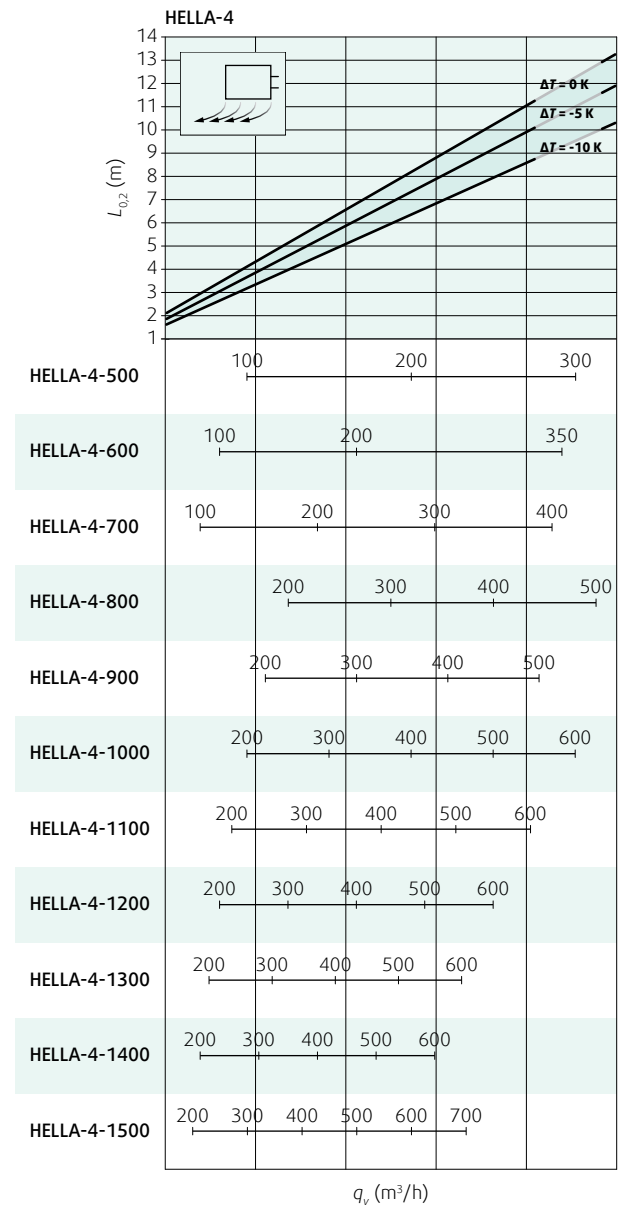

Diagram 19: Air throw length with terminal velocity 0,2 m/s (horizontal flow pattern)

Get In Touch

Call: [0845 6880112](tel:08456880112)
 Email: info@adremit.co.uk

Our Address

Puravent, Adremit Limited, Unit 5a, Commercial Yard,
 Settle, North Yorkshire, BD24 9RH

Installation, Maintenance & Operation

Information about installation, maintenance and operation are available in the User Manual (document "UserManual_HELLA").

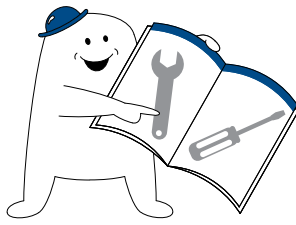

Transport & Storage

Dry indoor conditions with temperature range - 20 °C to + 40 °C.

Supplement

Any deviations from the technical specifications contained herein and the terms should be discussed with the manufacturer. We reserve the right to make any changes to the product without prior notice, provided that these changes do not affect the quality of the product and the required parameters. Current information on all products are available at www.systemair.com

Get In Touch

 Call: [0845 6880112](tel:08456880112)
 Email: info@adremit.co.uk

Our Address

Puravent, Adremit Limited, Unit 5a, Commercial Yard,
Settle, North Yorkshire, BD24 9RH

Related Products

KSV

Slot Diffusers

Product information is available within the technical documentation TechSpec_TPI-54.

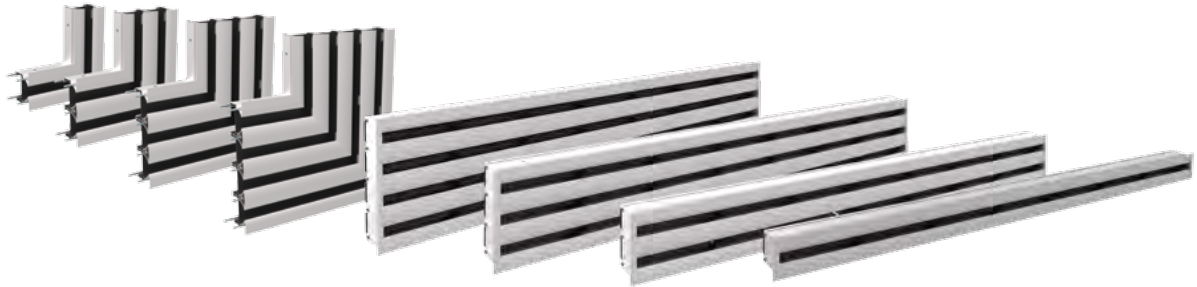

BS

Swimming Pool Slot Diffusers

Product information is available within the technical documentation TechSpec_TPI-95 and at www.systemair.com

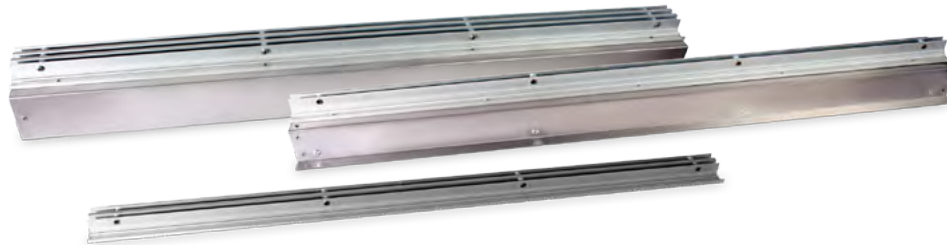

Get In Touch



Call: [0845 6880112](tel:08456880112)



Email: info@adremit.co.uk

Our Address

Puravent, Adremit Limited, Unit 5a, Commercial Yard,
Settle, North Yorkshire, BD24 9RH