

# CJBX CJBX/AL

**CJBX: Belt-driven acoustically-insulated ventilation units.**

**CJBX/AL: Belt-driven ventilation units with aluminium profiles and prefinished sheet steel and acoustic insulation.**



CJBX



CJBX/AL



High quality, extremely robust impeller, dynamically balanced in accordance with ISO 21940-11

## Options



CJBX/F



CJBX/ALS



CJBX/ALF

### Fan:

- Ventilation units fitted with double-inlet fans from the CBX, CBXC and CBXR series.
- Galvanised sheet steel structure with thermal and acoustic insulation.
- CJBX/AL, CJBX/ALS and CJBX/ALF: Aluminium profiles structure with thermal and acoustic insulation.
- Forward-curved impeller made of galvanised sheet steel.
- Cable gland for cable inlet.

### Motor:

- IE3 efficiency motors for powers equal to or greater than 0.75 kW except single-phase, 2-speed and 8-pole.
- Class F motors with ball bearings and IP55 protection.
- Three-phase 230/400 V-50 Hz (up to 4 kW) and 400/690 V-50 Hz (powers higher than 4 kW).
- Maximum temperature of air to be carried: -20 °C + 60 °C.

### Finish:

- Anti-corrosive finish on galvanised sheet steel.
- CJBX/AL, CJBX/ALS and CJBX/ALF: Anti-corrosive finish on pre-varnished sheet steel and aluminium profiles

### On request:

- With circular impulsion.

CJBX/AL and CJBX/ALS series accessories:

Air treatment modules:

- MF: Filtration module. Standard F6+F8 version and optional F7+F9.
- ME: Electric coil module. Standard G4 version and optional with F6+F8 or F7+F9 filters.
- MA: Water coil module. Standard G4 version and optional with F6+F8 or F7+F9 filters.

## Order code



CJBX: Acoustically insulated ventilation units  
 CJBX/AL: Belt-driven ventilation units with aluminium profiles and prefinished sheet steel and acoustic insulation  
 CJBX/F: Ventilation units with built-in filter  
 CJBX/ALS: Belt-driven ventilation units with double insulated wall, prefinished sheet and aluminium profiles  
 CJBX/ALF: Belt-driven ventilation units with prefinished sheet, built-in filter and aluminium profiles

Impeller size in inches

Motor power (HP)

## Technical characteristics

Model	Speed (r/min)	Maximum admissible current (A)			Installed power (kW)	Maximum flow rate (m <sup>3</sup> /h)	Sound pressure level (dB(A))	Approx. weight (kg)	Mounting type	According to ErP
		230 V	400 V	690 V						
CJBX CJBX/AL 7/7-0.75	1400	2.92	1.69	0.55	1200	56	41	A	2018	
CJBX CJBX/AL 7/7-1 IE3	1600	3.10	1.79	0.75	1450	58	43	A	2018	
CJBX CJBX/AL 9/9-0.25	825	1.23	0.71	0.18	1700	45	48	A	2018	
CJBX CJBX/AL 9/9-0.33	920	1.66	0.96	0.25	1800	48	50	A	2018	

## CENTRIFUGAL FANS AND IN-LINE DUCT EXTRACTOR FANS

### Technical characteristics

Model	Speed (r/min)	Maximum admissible current (A)			Installed power (kW)	Maximum flow rate (m <sup>3</sup> /h)	Sound pressure level (dB(A))	Approx. weight (kg)	Mounting type	According to ErP
		230 V	400 V	690 V						
CJBX CJBX/AL 9/9-0.5	1020	2.02	1.17		0.37	2200	51	52	A	2018
CJBX CJBX/AL 9/9-0.75	1050	2.92	1.69		0.55	2900	55	55	A	2018
CJBX CJBX/AL 9/9-1 IE3	1070	3.10	1.79		0.75	3200	56	56	A	2018
CJBX CJBX/AL 9/9-1.5 IE3	1260	4.03	2.32		1.10	3750	60	59	A	2018
CJBX CJBX/AL 10/10-0.75	845	2.92	1.69		0.55	3800	56	57	A	2018
CJBX CJBX/AL 10/10-1 IE3	960	3.10	1.79		0.75	4175	58	59	A	2018
CJBX CJBX/AL 10/10-1.5 IE3	1070	4.03	2.32		1.10	4800	61	61	A	2018
CJBX CJBX/AL 10/10-2 IE3	1140	5.96	3.44		1.50	5400	63	65	A	2018
CJBX CJBX/AL 12/12-0.5	595	2.02	1.17		0.37	4200	52	69	A	2018
CJBX CJBX/AL 12/12-0.75	675	2.92	1.69		0.55	4800	54	71	A	2018
CJBX CJBX/AL 12/12-1 IE3	765	3.10	1.79		0.75	5400	57	72	A	2018
CJBX CJBX/AL 12/12-1.5 IE3	855	4.03	2.32		1.10	5800	59	75	A	2018
CJBX CJBX/AL 12/12-2 IE3	965	5.96	3.44		1.50	6500	62	79	A	2018
CJBX CJBX/AL 12/12-3 IE3	1180	8.36	4.83		2.20	7400	65	87	A	2018
CJBX CJBX/AL 15/15-0.75	525	2.92	1.69		0.55	5900	49	85	B	2018
CJBX CJBX/AL 15/15-1 IE3	595	3.10	1.79		0.75	6500	52	86	B	2018
CJBX CJBX/AL 15/15-1.5 IE3	635	4.03	2.32		1.10	7500	54	89	B	2018
CJBX CJBX/AL 15/15-2 IE3	670	5.96	3.44		1.50	8200	56	93	B	2018
CJBX CJBX/AL 15/15-3 IE3	740	8.36	4.83		2.20	9500	59	101	B	2018
CJBX CJBX/AL 15/15-4 IE3	805	10.96	6.33		3.00	10600	61	103	B	2018
CJBX CJBX/AL 18/18-1.5 IE3	480	4.03	2.32		1.10	9000	48	122	B	2018
CJBX CJBX/AL 18/18-2 IE3	605	5.96	3.44		1.50	9250	51	125	B	2018
CJBX CJBX/AL 18/18-3 IE3	590	8.36	4.83		2.20	11500	54	134	B	2018
CJBX CJBX/AL 18/18-4 IE3	640	10.96	6.33		3.00	13200	56	136	B	2018
CJBX CJBX/AL 18/18-5.5 IE3	675	14.10	8.12		4.00	15000	58	141	B	2018
CJBX CJBX/AL 18/18-7.5 IE3	760		11.60	6.72	5.50	17000	60	155	B	2018
CJBX CJBX/AL 20/20-2 IE3	430	5.96	3.44		1.50	11500	56	222	B	2018
CJBX CJBX/AL 20/20-3 IE3	530	8.36	4.83		2.20	12800	57	231	B	2018
CJBX CJBX/AL 20/20-4 IE3	575	10.96	6.33		3.00	14200	58	233	B	2018
CJBX CJBX/AL 20/20-5.5 IE3	635	14.10	8.12		4.00	15500	61	238	B	2018
CJBX CJBX/AL 20/20-7.5 IE3	675		11.60	6.72	5.50	17500	63	252	B	2018
CJBX CJBX/AL 20/20-10 IE3	725		13.90	8.06	7.50	20000	65	283	B	2018
CJBX CJBX/AL 22/22-2 IE3	385	5.96	3.44		1.50	14000	50	250	B	2018
CJBX CJBX/AL 22/22-3 IE3	475	8.36	4.83		2.20	15000	54	257	B	2018
CJBX CJBX/AL 22/22-4 IE3	515	10.96	6.33		3.00	17000	55	261	B	2018
CJBX CJBX/AL 22/22-5.5 IE3	570	14.10	8.12		4.00	19000	57	265	B	2018
CJBX CJBX/AL 22/22-7.5 IE3	605		11.60	6.72	5.50	21500	60	279	B	2018
CJBX CJBX/AL 22/22-10 IE3	675		13.90	8.06	7.50	25000	63	306	B	2018
CJBX CJBX/AL 22/22-15 IE3	765		20.90	12.10	11.00	27000	65	341	B	2018
CJBX CJBX/AL 25/25-3 IE3	375	8.36	4.83		2.20	17000	53	297	B	2018
CJBX CJBX/AL 25/25-4 IE3	405	10.96	6.33		3.00	20500	55	299	B	2018
CJBX CJBX/AL 25/25-5.5 IE3	450	14.10	8.12		4.00	22000	57	304	B	2018
CJBX CJBX/AL 25/25-7.5 IE3	485		11.60	6.72	5.50	24500	59	318	B	2018
CJBX CJBX/AL 25/25-10 IE3	545		13.90	8.06	7.50	28000	61	345	B	2018
CJBX CJBX/AL 25/25-15 IE3	610		20.90	12.10	11.00	32000	64	374	B	2018
CJBX CJBX/AL 30/28-3 IE3	330	8.36	4.83		2.20	20000	54	380	B	2018
CJBX CJBX/AL 30/28-4 IE3	360	10.96	6.33		3.00	22000	56	382	B	2018
CJBX CJBX/AL 30/28-5.5 IE3	380	14.10	8.12		4.00	25000	59	387	B	2018
CJBX CJBX/AL 30/28-7.5 IE3	380		11.60	6.72	5.50	31500	60	402	B	2018
CJBX CJBX/AL 30/28-10 IE3	410		13.90	8.06	7.50	36000	63	431	B	2018
CJBX CJBX/AL 30/28-15 IE3	430		20.90	12.10	11.00	42000	65	451	B	2018
CJBX CJBX/AL 30/28-20 IE3	480		27.90	16.20	15.00	48000	68	466	B	2018



### Erp. (Energy Related Products)

Information on Directive 2009/125/EC can be downloaded from the SODECA website or the QuickFan selector programme.

#### Get In Touch

Call: 0845 6880112  
Email: [info@adremit.co.uk](mailto:info@adremit.co.uk)

#### Our Address

Puravent, Adremit Limited, Unit 5a, Commercial Yard,  
Settle, North Yorkshire, BD24 9RH

## Dimensions mm

**CJBX**  
Standard supply  
Horizontal impulsion  
(H) LG 90

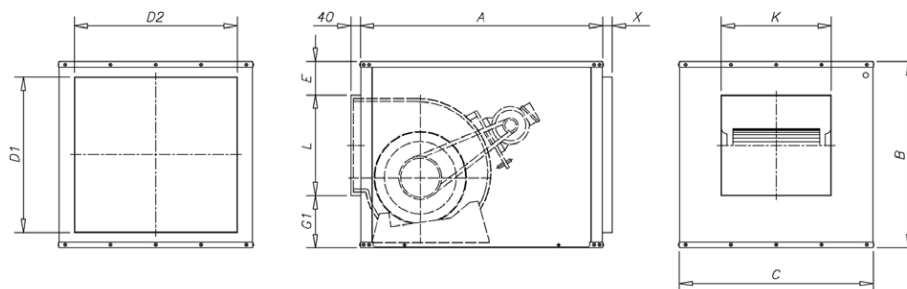

**CJBX/F**

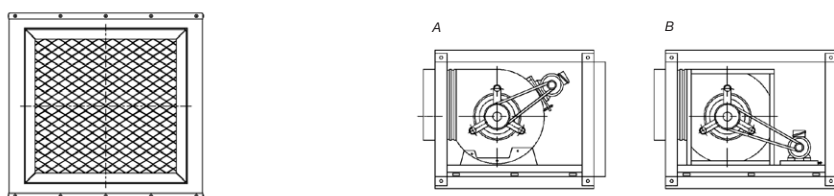

	A	B	C	D1	D2	E	G1	L	K	X (without filter)	X (with filter)
CJBX-7/7	650	460	500	364	404	107	135	218	240	30	40
CJBX-9/9	700	522	550	426	454	101	151	270	310	30	40
CJBX-10/10	750	575	600	479	504	100	175	300	336	30	40
CJBX-12/12	850	650	700	554	604	84	205	361	404	30	40
CJBX-15/15	1000	755	800	659	704	62	270	423	486	30	40
CJBX-18/18	1200	875	1000	779	904	45	336	494	551	30	40
CJBX-20/20	1400	1175	1100	1079	1004	147	428	600	600	30	40
CJBX-22/22	1460	1250	1250	1154	1154	145	413	692	653	30	40
CJBX-25/25	1550	1375	1450	1279	1354	152	431	792	762	30	40
CJBX-30/28	1800	1600	1650	1504	1554	140	528	932	885	30	40

On request  
vertical impulsion  
(V) LG 0

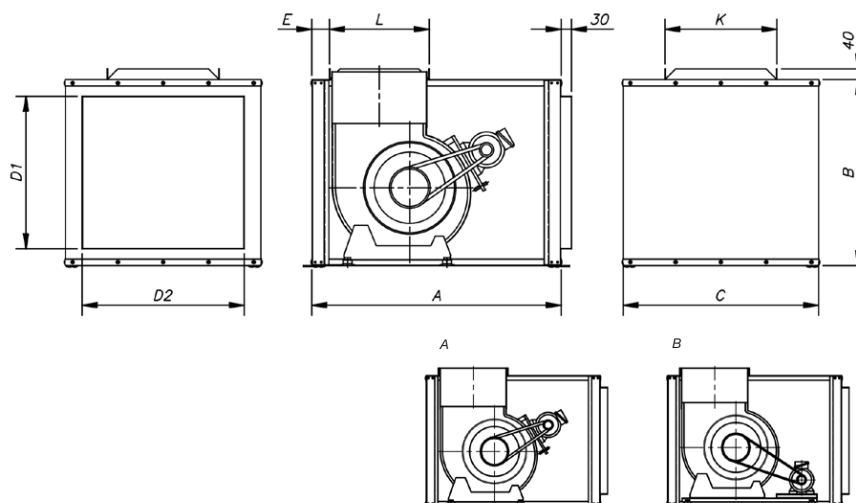

	A	B	C	D1xD2	E	L	K
CJBX-7/7	650	460	500	364x404	30	204	226
CJBX-9/9	700	522	550	426x454	30	256	296
CJBX-10/10	750	575	600	479x504	30	286	322
CJBX-12/12	850	650	700	554x604	30	341	383
CJBX-15/15	1000	755	800	659x704	30	404	471
CJBX-18/18	1200	875	1000	779x904	30	484	537
CJBX-20/20	1445	1175	1100	1079x1004	60	600	600
CJBX-22/22	1580	1250	1250	1154x1154	60	692	653
CJBX-25/25	1675	1375	1450	1279x1354	60	792	762
CJBX-30/28	1935	1600	1650	1504x1554	60	932	885

### Get In Touch

Call: 0845 6880112  
Email: [info@adremit.co.uk](mailto:info@adremit.co.uk)

### Our Address

Puravent, Adremit Limited, Unit 5a, Commercial Yard,  
Settle, North Yorkshire, BD24 9RH

**Dimensions mm**

**CJBX/AL**  
Standard supply  
Horizontal impulsion  
(H) LG 90

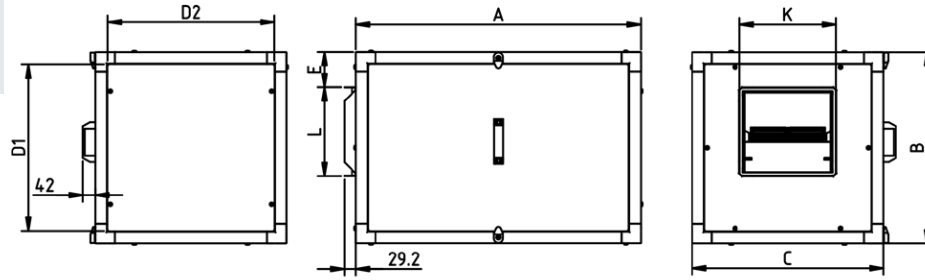

**CJBX/ALF**

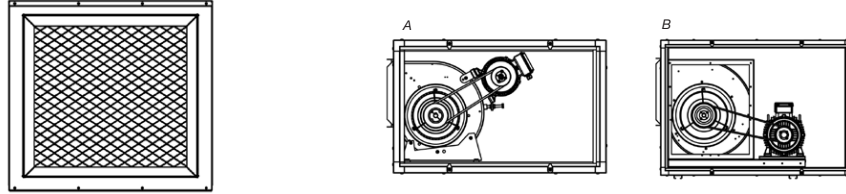

	A	B	C	D1	D2	E	L	K	MOUNTING
CJBX-AL / CJBX-ALS / CJBX-ALF 7/7	830	490	490	428	428	91	226	247	A
CJBX-AL / CJBX-ALS / CJBX-ALF 9/9	920	550	550	488	488	86	279	317	A
CJBX-AL / CJBX-ALS / CJBX-ALF 10/10	970	605	605	543	543	88	306	343	A
CJBX-AL / CJBX-ALS / CJBX-ALF 12/12	1050	680	680	618	618	84	360	404	A
CJBX-AL / CJBX-ALS / CJBX-ALF 15/15	1220	855	855	793	793	119	423	490	B
CJBX-AL / CJBX-ALS / CJBX-ALF 18/18	1356	1000	1000	938	938	137	498	554	B
CJBX-AL / CJBX-ALS / CJBX-ALF 20/20	1500	1195	1195	1115	1115	140	615	615	B
CJBX-AL / CJBX-ALS / CJBX-ALF 22/22	1600	1250	1250	1170	1170	104	705	668	B
CJBX-AL / CJBX-ALS / CJBX-ALF 25/25	1870	1450	1450	1370	1370	200	792	767	B
CJBX-AL / CJBX-ALS / CJBX-ALF 30/28	1975	1670	1670	1590	1590	188	938	896	B

**CJBX/AL**  
On request  
vertical impulsion  
(V) LG 0

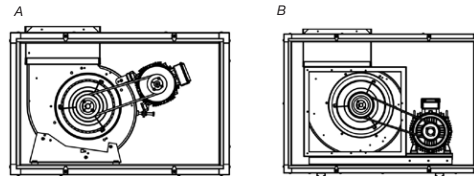
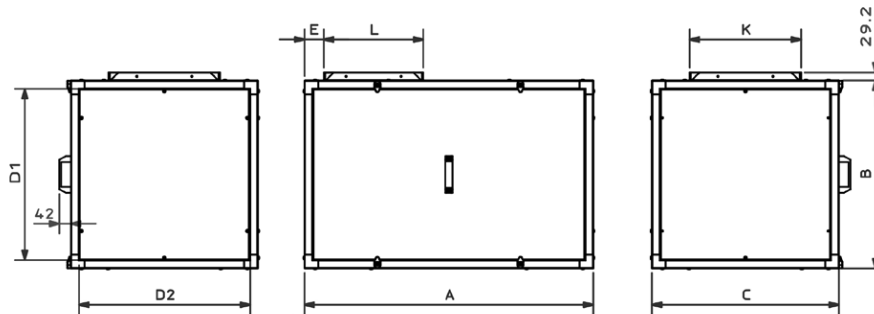

	A	B	C	D1	D2	E	L	K	MOUNTING
CJBX-AL / CJBX-ALS / CJBX-ALF 7/7	830	490	490	428	428	63	226	247	A
CJBX-AL / CJBX-ALS / CJBX-ALF 9/9	920	550	500	488	488	85	279	317	A
CJBX-AL / CJBX-ALS / CJBX-ALF 10/10	970	605	605	543	543	87	306	343	A
CJBX-AL / CJBX-ALS / CJBX-ALF 12/12	1050	680	680	618	618	69	360	404	A
CJBX-AL / CJBX-ALS / CJBX-ALF 15/15	1220	855	855	793	793	115	423	490	B
CJBX-AL / CJBX-ALS / CJBX-ALF 18/18	1356	1000	1000	938	938	80	498	554	B
CJBX-AL / CJBX-ALS / CJBX-ALF 20/20	1500	1195	1195	1115	1115	125	615	615	B
CJBX-AL / CJBX-ALS / CJBX-ALF 22/22	1600	1250	1250	1170	1170	125	705	668	B
CJBX-AL / CJBX-ALS / CJBX-ALF 25/25	1870	1450	1450	1370	1370	85	792	767	B
CJBX-AL / CJBX-ALS / CJBX-ALF 30/28	1975	1670	1670	1590	1590	155	938	896	B



### Characteristic curves

Q= Flow rate in m<sup>3</sup>/h, m<sup>3</sup>/s and cfm

Pe= Static pressure in mm H<sub>2</sub>O, Pa and inwg

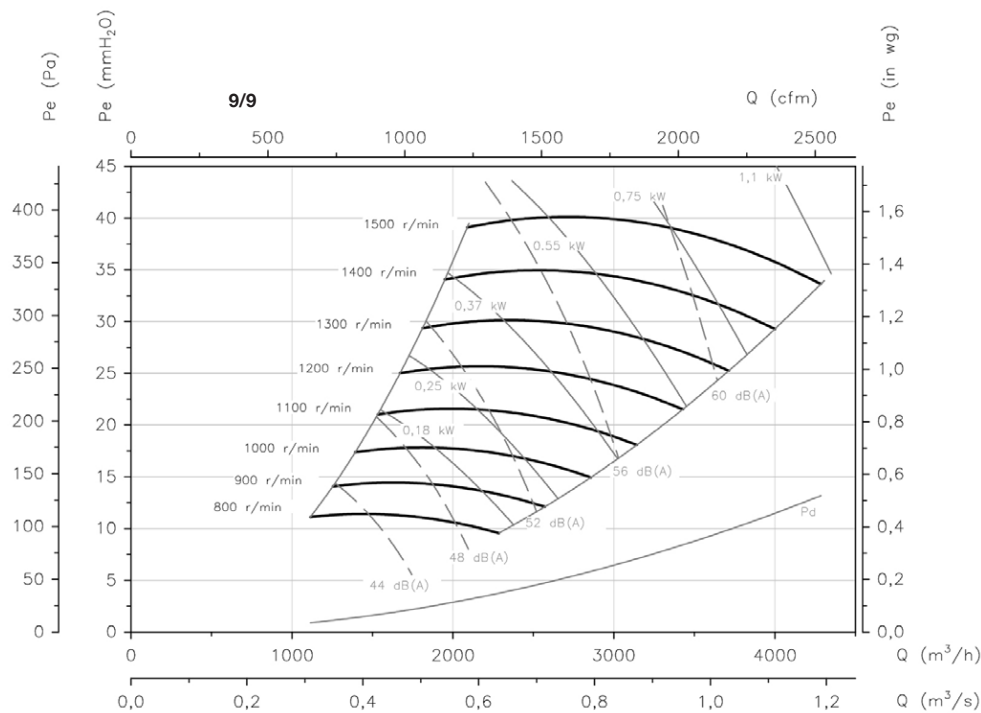
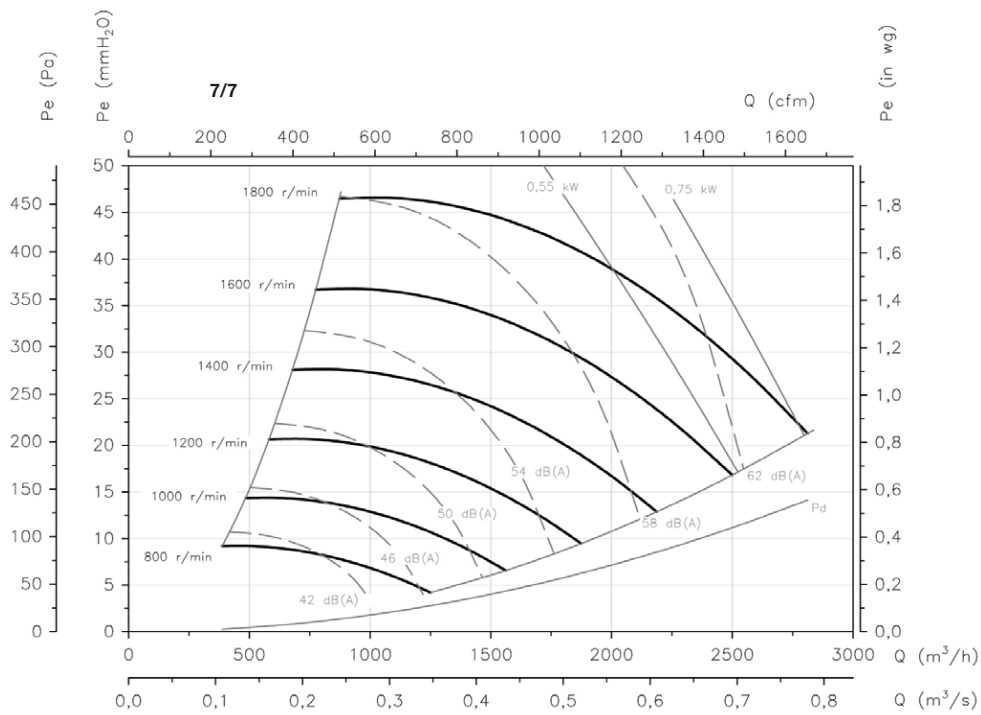

#### Get In Touch

Call: 0845 6880112  
 Email: [info@adremit.co.uk](mailto:info@adremit.co.uk)

#### Our Address

Puravent, Adremit Limited, Unit 5a, Commercial Yard,  
 Settle, North Yorkshire, BD24 9RH

**Characteristic curves**

Q= Flow rate in m<sup>3</sup>/h, m<sup>3</sup>/s and cfm

Pe= Static pressure in mm H<sub>2</sub>O, Pa and inwg

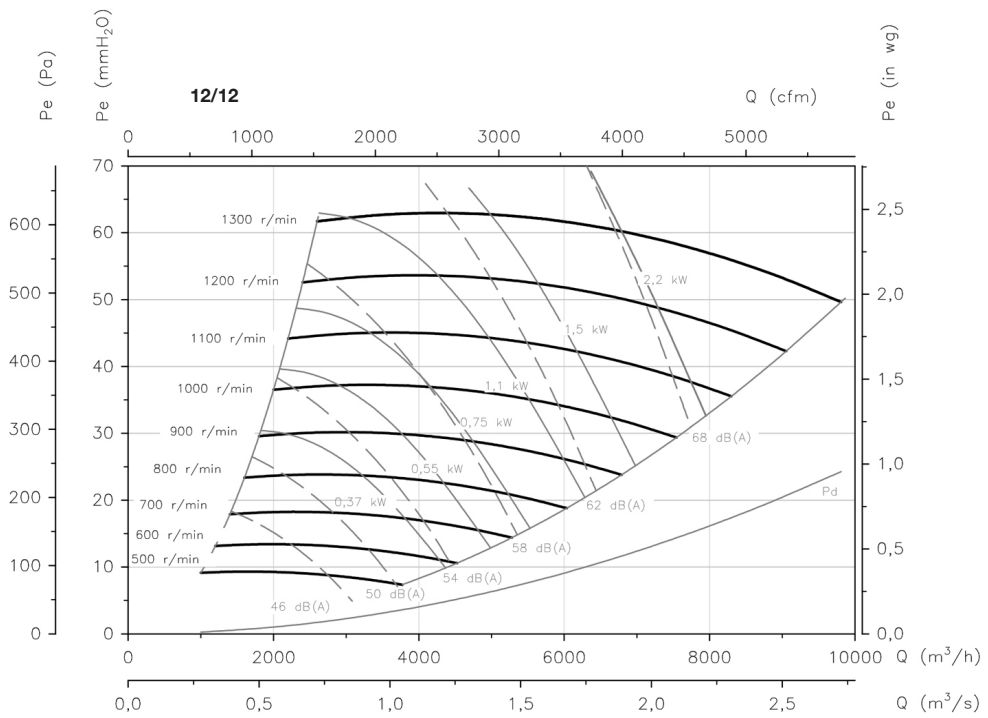
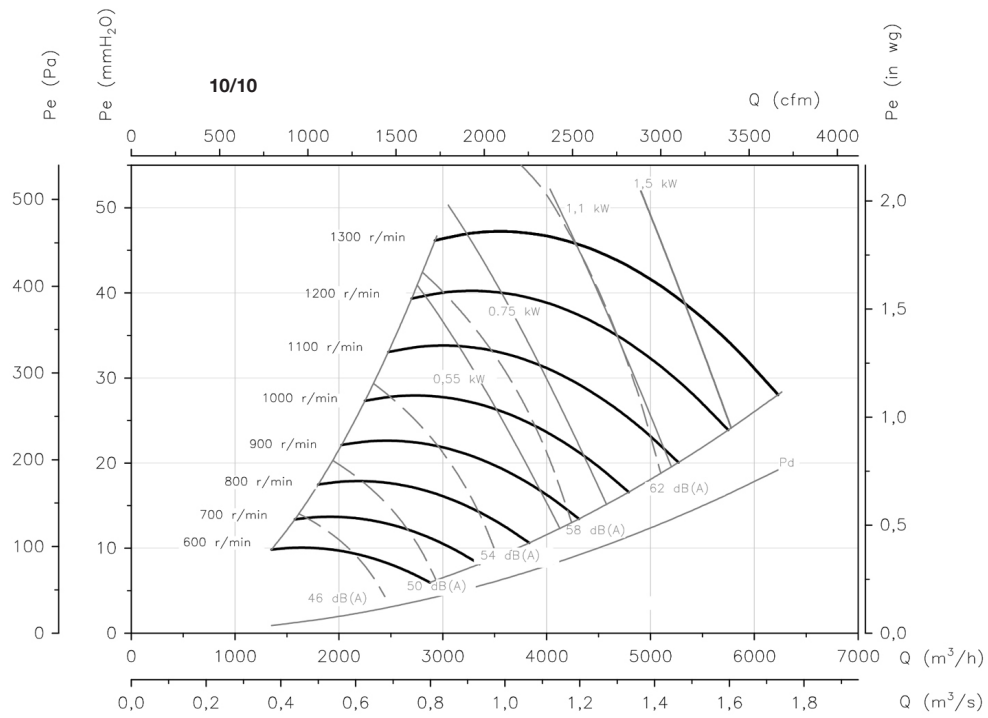

**Get In Touch**

Call: 0845 6880112  
 Email: [info@adremit.co.uk](mailto:info@adremit.co.uk)

**Our Address**

Puravent, Adremit Limited, Unit 5a, Commercial Yard,  
 Settle, North Yorkshire, BD24 9RH



### Characteristic curves

Q= Flow rate in m<sup>3</sup>/h, m<sup>3</sup>/s and cfm

Pe= Static pressure in mm H<sub>2</sub>O, Pa and inwg

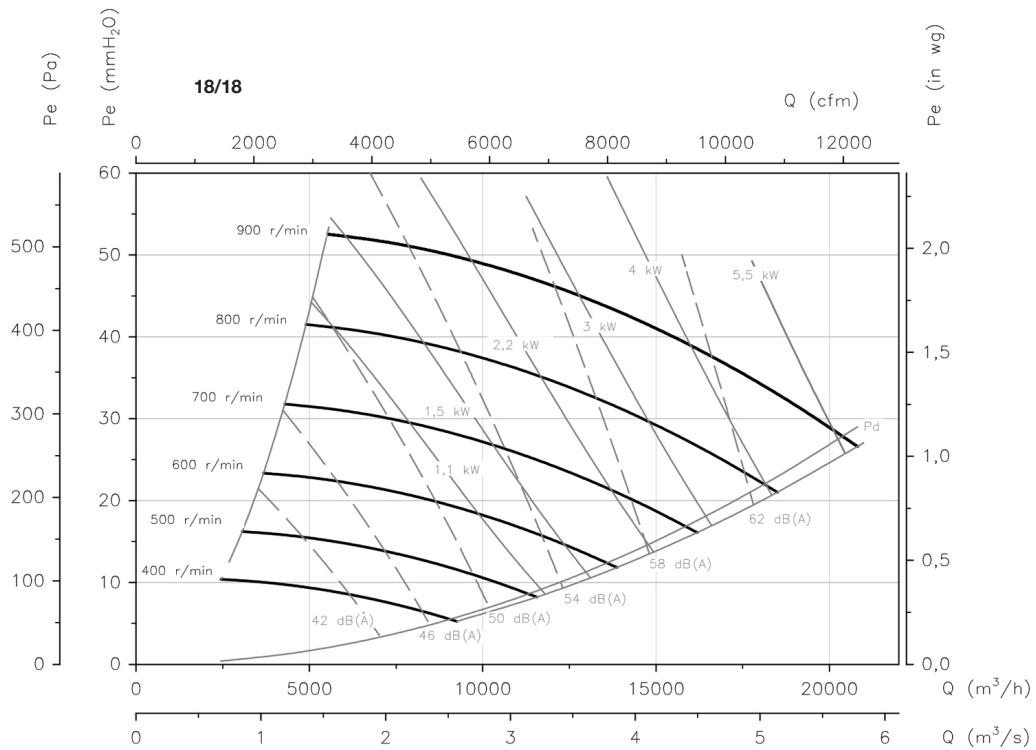
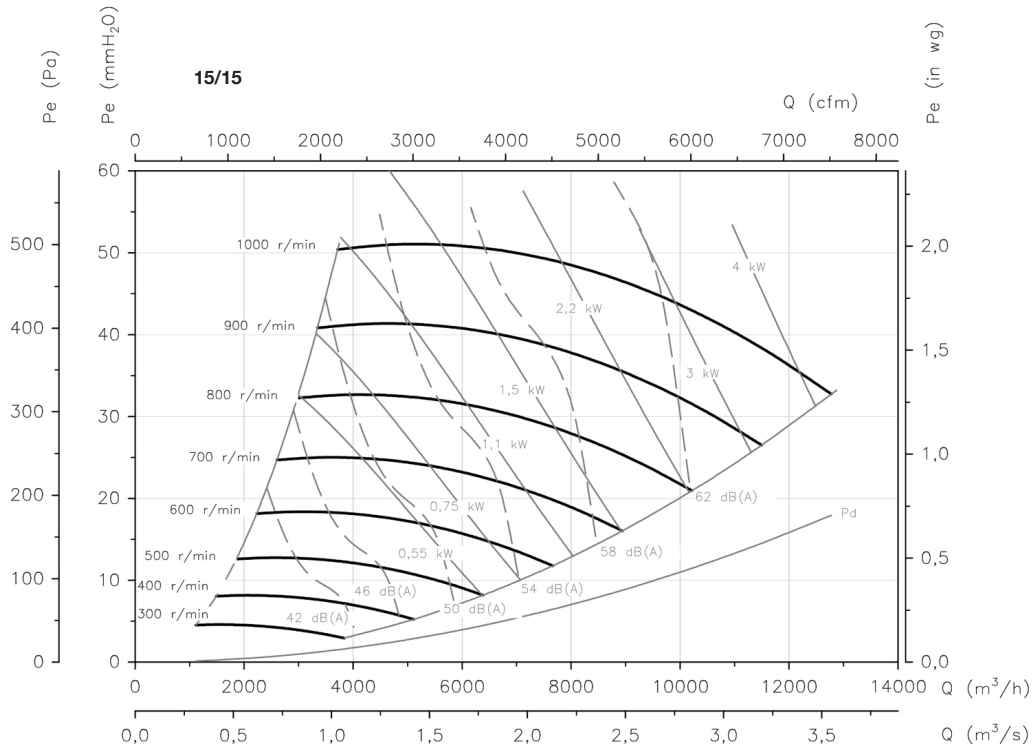

#### Get In Touch

Call: 0845 6880112  
 Email: [info@adremit.co.uk](mailto:info@adremit.co.uk)

#### Our Address

Puravent, Adremit Limited, Unit 5a, Commercial Yard,  
 Settle, North Yorkshire, BD24 9RH



**Characteristic curves**

Q= Flow rate in m<sup>3</sup>/h, m<sup>3</sup>/s and cfm

Pe= Static pressure in mm H<sub>2</sub>O, Pa and inwg

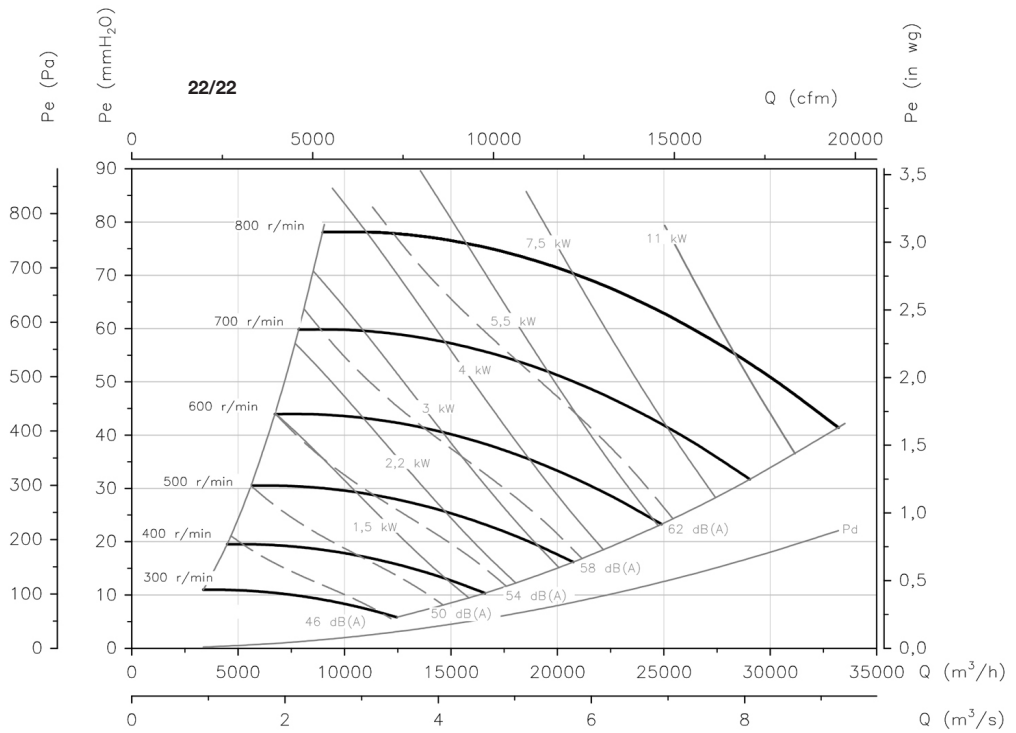
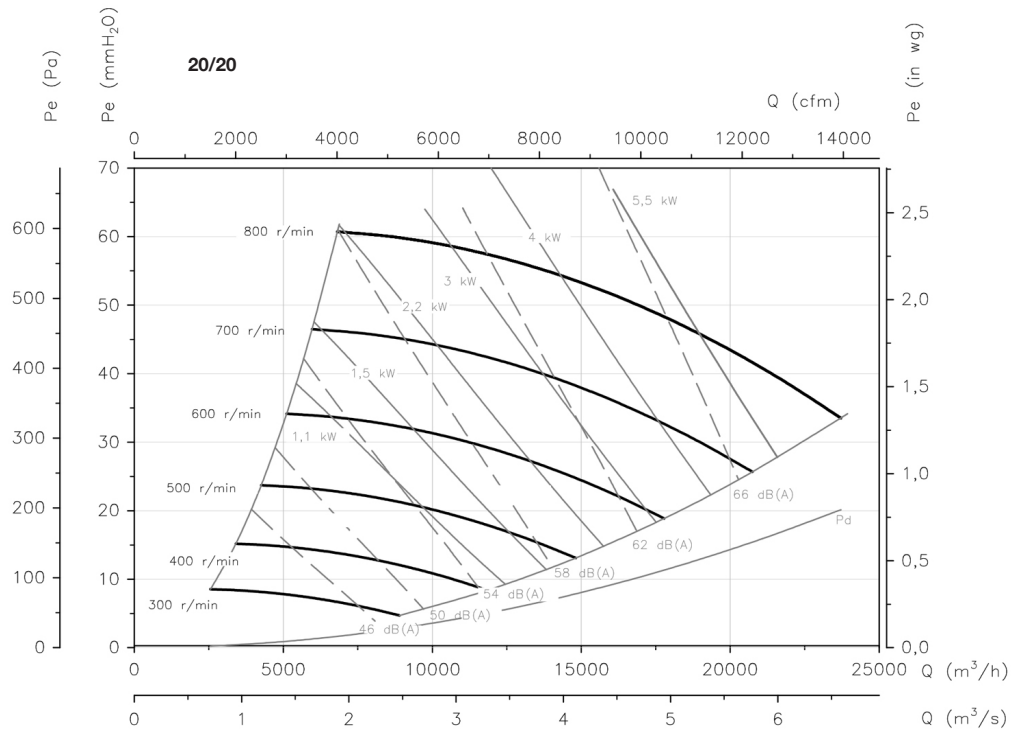



### Characteristic curves

Q= Flow rate in m<sup>3</sup>/h, m<sup>3</sup>/s and cfm

Pe= Static pressure in mm H<sub>2</sub>O, Pa and inwg

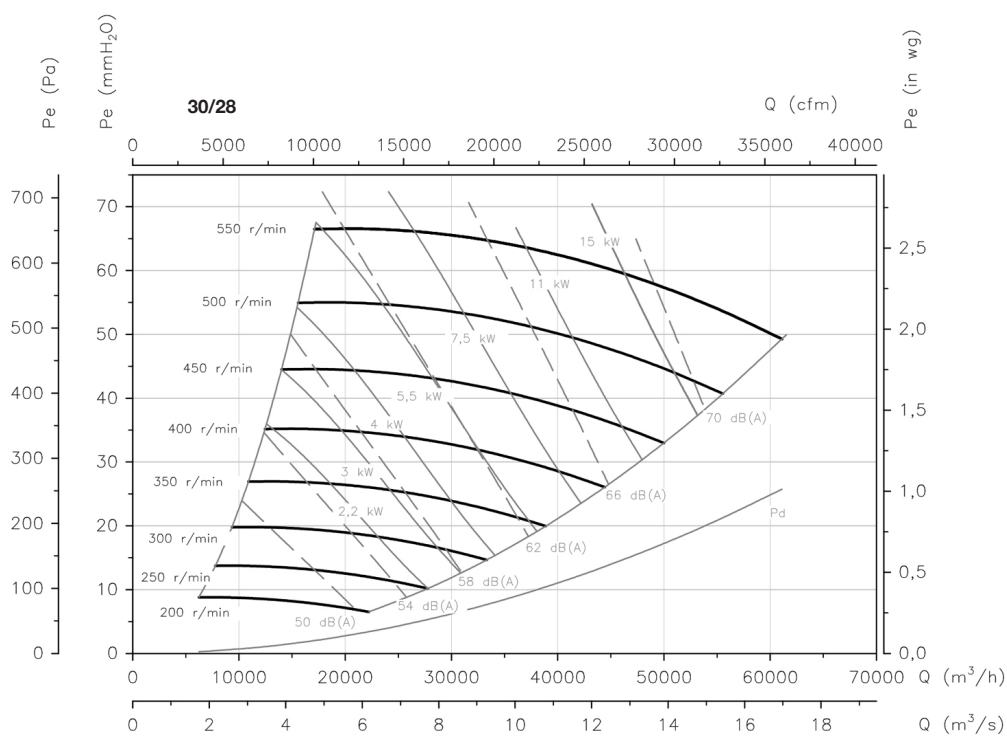
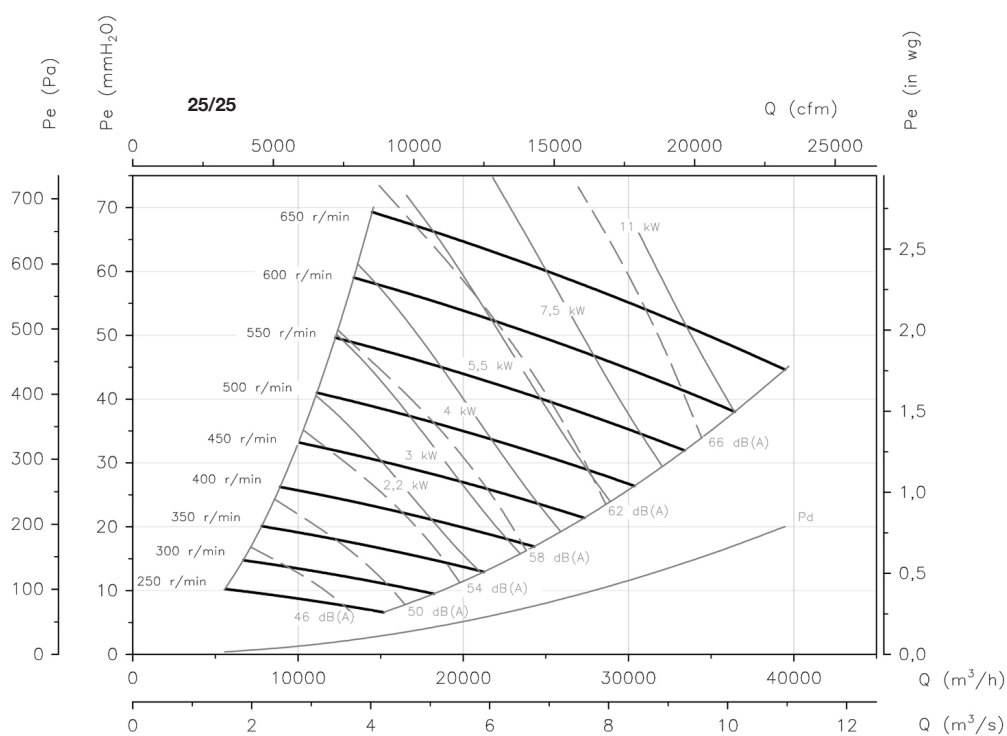

#### Get In Touch

Call: 0845 6880112  
 Email: [info@adremit.co.uk](mailto:info@adremit.co.uk)

#### Our Address

Puravent, Adremit Limited, Unit 5a, Commercial Yard,  
 Settle, North Yorkshire, BD24 9RH

**Characteristic curves**

Q= Flow rate in m<sup>3</sup>/h, m<sup>3</sup>/s and cfm

Pe= Static pressure in mm H<sub>2</sub>O, Pa and inwg



**Load loss curves of units with filters**

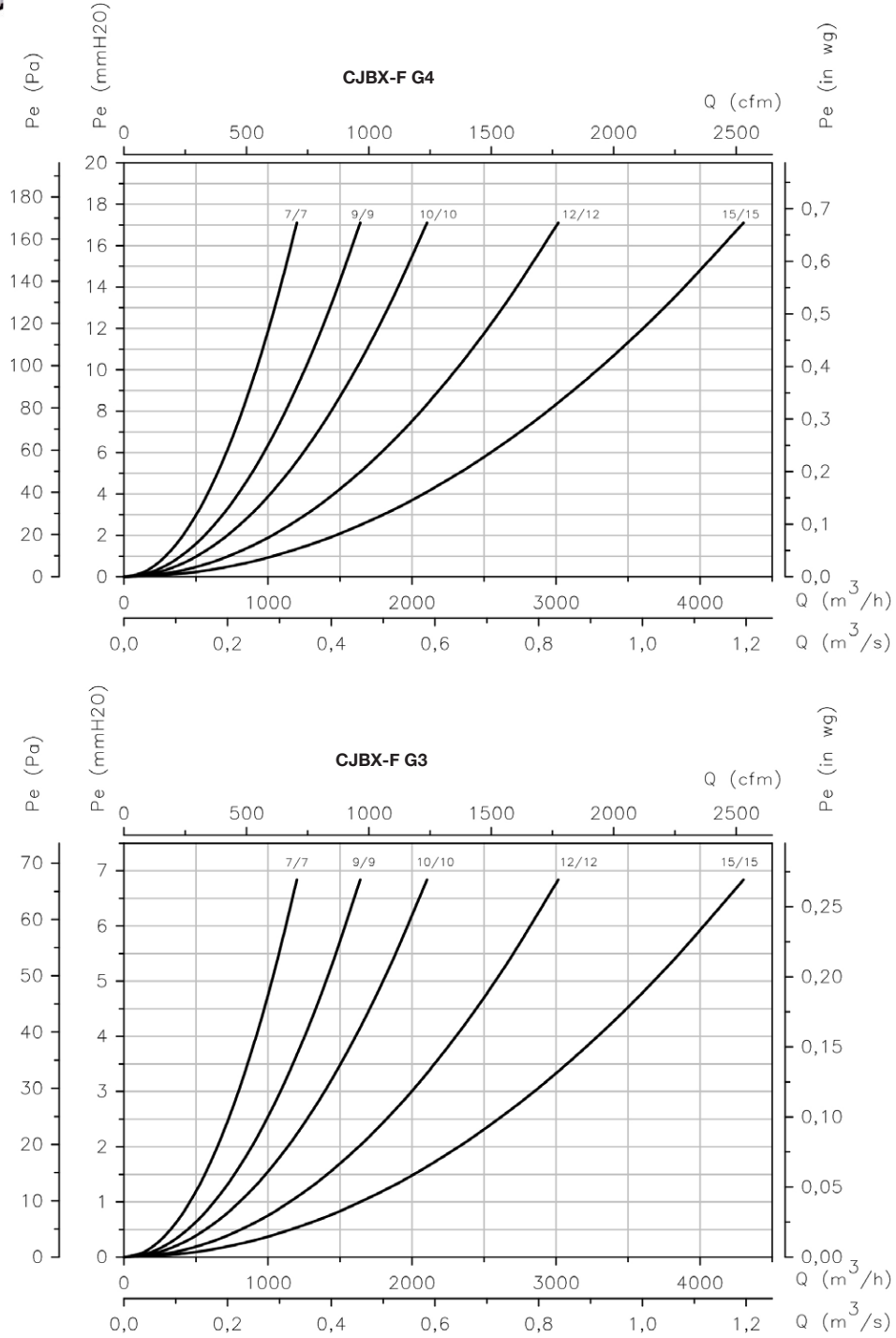

**Get In Touch**

Call: 0845 6880112  
 Email: [info@adremit.co.uk](mailto:info@adremit.co.uk)

**Our Address**

Puravent, Adremit Limited, Unit 5a, Commercial Yard, Settle, North Yorkshire, BD24 9RH



### Characteristic curves

Q= Flow rate in m<sup>3</sup>/h, m<sup>3</sup>/s and cfm

Pe= Static pressure in mm H<sub>2</sub>O, Pa and inwg



#### Load loss curves of units with filters

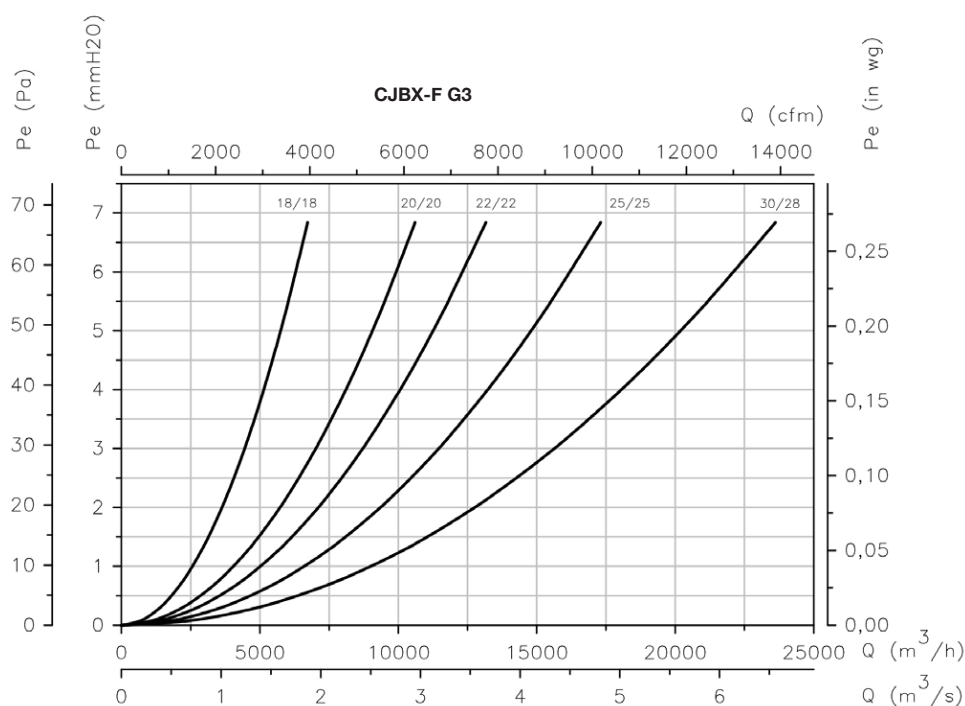
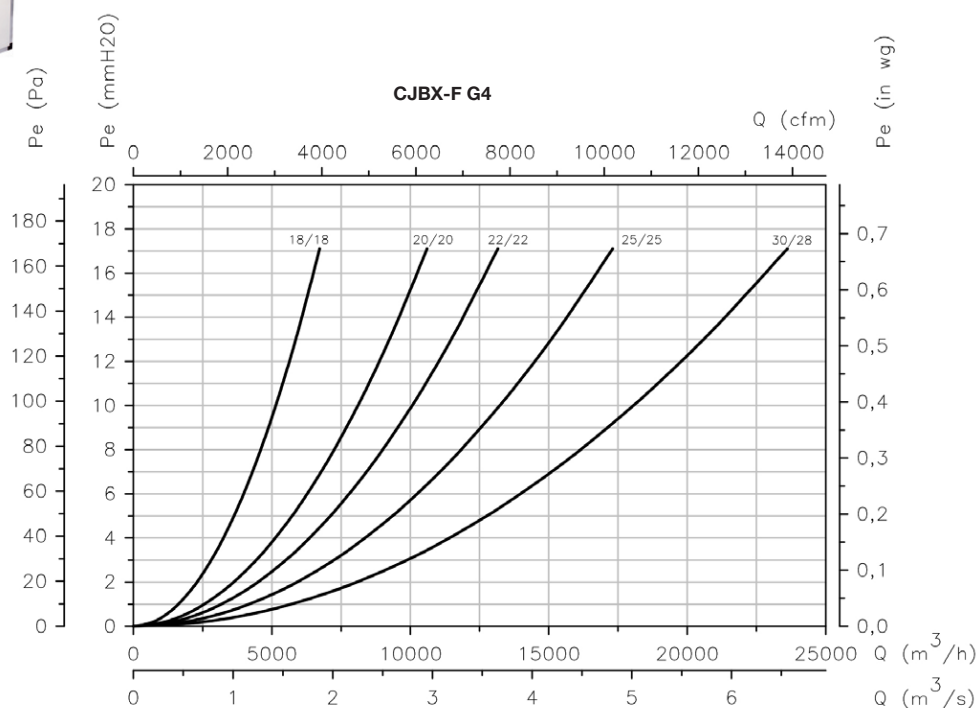

### Accessories

See accessories section.



INT

C2V

RM

VSD3/A-RFT

AET

VIS

TEJ

### Get In Touch

Call: 0845 6880112  
 Email: [info@adremit.co.uk](mailto:info@adremit.co.uk)

### Our Address

Puravent, Adremit Limited, Unit 5a, Commercial Yard,  
 Settle, North Yorkshire, BD24 9RH