



Fan heater SWH

Intelligent fan heater with extremely low sound level, for water connection



Application

SWH is a quiet running fan heater which, together with the SIRE control system, provides fully automatic room heating, adaptable to every unique application.

SWH is suitable for use in premises where fan heaters are traditionally used, such as industrial buildings, as well as environments with low sound requirements.

Comfort

With its extremely low sound level SWH is Frico's quietest fan heater. SWH quickly gives a pleasant heat where it is needed.

Operation and economy

SWH is an energy efficient fan heater that never uses more energy than necessary. The energy efficiency is even higher for units equipped with EC motors. Eco mode is available in the control system for further energy savings.

The pre-programmed factory settings and calendar function make SWH easy to install and use. SWH can be controlled and monitored by the BMS system.

Design



The SWH fan heater has an attractive design in white sheet steel to blend into both industrial and shop environments.

Product specifications

- Fan heater SWH is available in the following designs:
 - **SWH**, standard unit.
 - **SWH EC** is equipped with an EC motor and has thus a low energy consumption and adjustable fan steps.
- Used with the SIRE control system, which has many smart and energy saving functions.
- Very low sound level.
- Five fan speeds.
- Mounted on the wall or ceiling.
- Intended for water temperatures up to +150 °C and 10 bar in standard design.
- Supplied with air director with individually adjustable louvres that direct the air flow on one plane.
- Max. surrounding temperature +40 °C.
- Heating coil with aluminum fins and copper pipes. Smooth pipe connection, for soldering or clamping ring pipe connection.
- Wide range of controls and accessories.
- Corrosion proof housing made of hot zinc-plate and powder enameled steel panels. Colour: RAL 9016, NCS S 0500-N (white). Housing without lacquer or in other colours available on request. Aluminium louvres.

Design and specifications are subject to change without notice.

Get In Touch

 Call: [01729 824108](tel:01729824108)
 Email: info@puravent.co.uk

Our Address

Puravent, Adremit Limited, 6 County Business Park,
Darlington Road, Northallerton, DL6 2NQ





Thanks to the low sound level combined with powerful performance SWH is suitable for everything from warehousing to shops.



By turning the SWH, pipe connections are possible on both sides which makes it very easy to position. The air director, which has individually adjustable louvres directs the air flow as required.

Get In Touch

 Call: [01729 824108](tel:01729824108)
 Email: info@puravent.co.uk

Our Address

Puravent, Adremit Limited, 6 County Business Park,
Darlington Road, Northallerton, DL6 2NQ

Fan heater SWH

Technical specifications

Fan heater SWH (IP44)

Type	Heat output* ^{1,2} [kW]	Air flow* ² [m ³ /h]	Air flow* ² [m ³ /s]	Sound power* ³ [dB(A)]	Sound pressure* ^{2,4} [dB(A)]	Δt * ^{1,2,5} [°C]	Water volume* ⁶ [l]	Voltage [V]	Amperage [A]	Weight [kg]
SWH02	6,8/11	450/1000	0,15/0,31	56	19/40	38/30	1,3	230V~	0,34	20
SWH12	8,7/17	760/2020	0,21/0,56	64	26/48	34/24	1,5	230V~	0,7	24
SWH22	19/29	1770/3370	0,49/0,94	70	40/55	31/25	2,7	230V~	1,2	34
SWH32	29/44	2670/5200	0,74/1,44	67	39/51	31/25	3,8	230V~	1,7	55
SWH33	32/53	2250/4450	0,62/1,23	66	38/50	41/35	5,2	230V~	1,7	59

Fan heater with EC motor SWH EC (IP44)

Type	Heat output* ^{1,2} [kW]	Air flow* ² [m ³ /h]	Air flow* ² [m ³ /s]	Sound power* ³ [dB(A)]	Sound pressure* ^{2,4} [dB(A)]	Δt * ^{1,2,5} [°C]	Water volume* ⁶ [l]	Voltage [V]	Amperage* ⁷ [A]	Weight [kg]
SWHEC02	6,8/11	530/1000	0,15/0,28	56	25/40	38/31	1,3	230V~	0,2/0,7	20
SWHEC12	8,7/17	760/2020	0,21/0,56	63	22/48	33/24	1,5	230V~	0,4/1,1	24
SWHEC22	19/29	1770/3370	0,49/0,94	72	43/56	31/25	2,7	230V~	1,1/1,2	34
SWHEC32	28/44	2670/5200	0,74/1,44	67	35/51	31/24	3,8	230V~	1,1/1,7	55
SWHEC33	32/53	2250/4500	0,63/1,25	65	33/50	41/35	5,2	230V~	1,2/1,8	59

*1) Applicable at water temperature 80/60 °C, air temperature, in +15 °C.

*2) Applies to fan position 1 / 4.

*3) Sound power (L_{WA}) measurements according to ISO 27327-2: 2014, Installation type E.

*4) Sound pressure (L_{pA}). Conditions: Distance to the unit 5 metres. Directional factor: 2. Equivalent absorption area: 200 m².

*5) Δt = temperature rise of passing air.

*6) Water volume inside water coil.

*7) Applies to fan position 4 / 5.

Approved for 220V/1ph/60Hz. Product performance for 220V/1ph/60Hz will differ from stated data.

Air throw

Type	Air throw [m]	Air throw with extra air director [m]
SWH02	7	-
SWH12	11	17
SWH22	19	25
SWH32	25	33
SWH33	23	29
SWHEC02	7	-
SWHEC12	11	17
SWHEC22	19	25
SWHEC32	25	33
SWHEC33	23	29

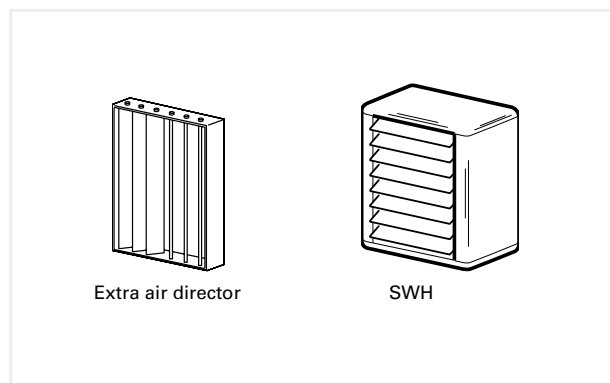

The air throw data is valid at fan position 4 and room temperature +18 °C. The air throw is defined as the distance in a straight angle from the fan heater to the point where the average air speed has dropped to 0,5 m/s.

Get In Touch

Call: [01729 824108](tel:01729824108)
Email: info@puravent.co.uk

Our Address

Puravent, Adremit Limited, 6 County Business Park,
Darlington Road, Northallerton, DL6 2N0



Dimensions

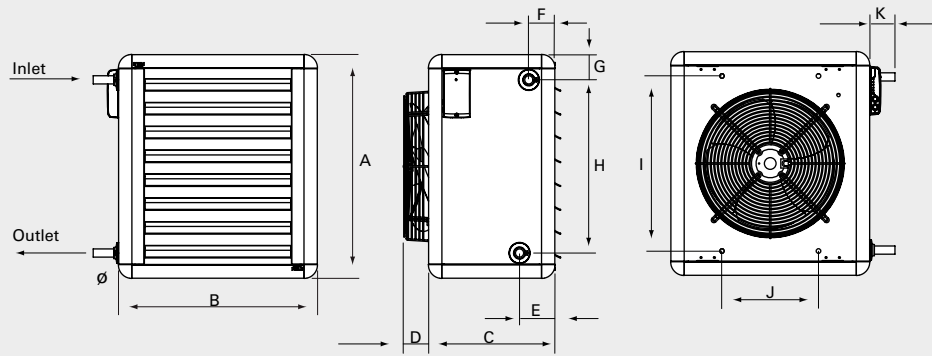

	A [mm]	B [mm]	C [mm]	E [mm]	F [mm]	G [mm]	H [mm]	I [mm]	J [mm]	K [mm]	Ø [mm]
SWH02, SWHEC02	525	515	320	95	70	70	390	405	260	70	22
SWH12, SWHEC12	600	535	340	95	70	70	465	470	260	70	22
SWH22, SWHEC22	725	680	370	100	70	70	585	580	400	75	28
SWH32/33, SWHEC32/33	850	820	450	100	70	70	710	700	530	75	28

	D [mm]
SWH02	40
SWH12	70
SWH22	50
SWH32/33	102

	D [mm]
SWHEC02	110
SWHEC12	85
SWHEC22	35
SWHEC32/33	100

Mounting brackets, SWB

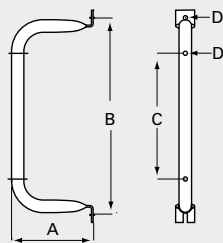

	A [mm]	B [mm]	C [mm]	D [mm]
SWB0	195	405	235	10
SWB1	195	470	300	10
SWB2	250	580	410	10
SWB3	335	700	530	10

Filter section, SWF

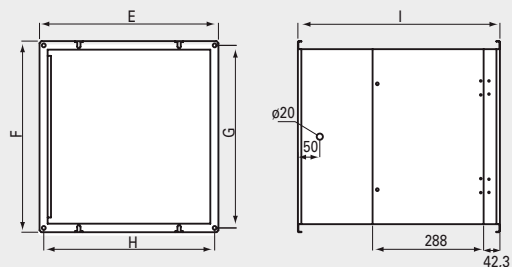

	E [mm]	F [mm]	G [mm]	H [mm]	I [mm]
SWF1	466	492	470	444	524
SWF2	616	602	580	594	524
SWF3	746	722	700	724	524

Return air intake, SWD

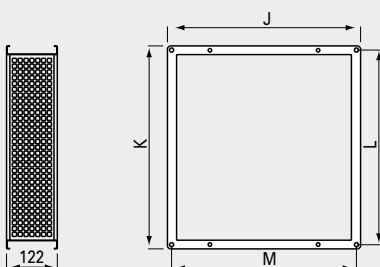

	J [mm]	K [mm]	L [mm]	M [mm]
SWD1	464	490	470	444
SWD2	614	600	580	594
SWD3	676	720	700	656



Get In Touch

Call: 01729 824108
Email: info@puravent.co.uk

Our Address

Puravent, Adremit Limited, 6 County Business Park,
Darlington Road, Northallerton, DL6 2N0



Fan heater SWH

Accessories

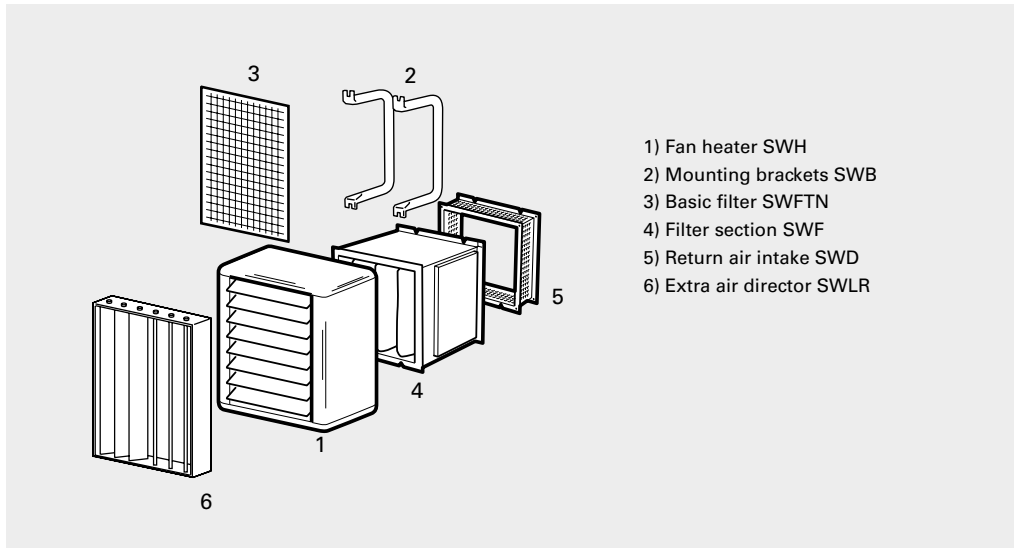

- 1) Fan heater SWH
- 2) Mounting brackets SWB
- 3) Basic filter SWFTN
- 4) Filter section SWF
- 5) Return air intake SWD
- 6) Extra air director SWLR

Type	Description				
		SWH02	SWH12	SWH22	SWH32/33
SWB0	Mounting brackets	•			
SWB1	Mounting brackets		•		
SWB2	Mounting brackets			•	
SWB3	Mounting brackets				•
SWF1	Filter section		•		
SWF2	Filter section			•	
SWF3	Filter section				•
SWD1	Return air intake		•		
SWD2	Return air intake			•	
SWD3	Return air intake				•
SWEF1	Extra filter cassette		•		
SWEF2	Extra filter cassette			•	
SWEF3	Extra filter cassette				•
SWFTN02	Basic filter	•			
SWFTN1	Basic filter		•		
SWFTN2	Basic filter			•	
SWFTN3	Basic filter				•
SWLR1	Extra air director		•		
SWLR2	Extra air director			•	
SWLR3	Extra air director				•



Get In Touch

 Call: [01729 824108](tel:01729824108)
 Email: info@puravent.co.uk

Our Address

Puravent, Adremit Limited, 6 County Business Park,
 Darlington Road, Northallerton, DL6 2N0



Accessories SWH02-33

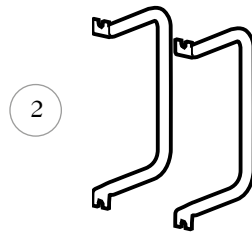

SWB, mounting brackets
When not using the filter section the main unit is suspended from the wall or ceiling using brackets SWB (fig 2). Brackets are extra and supplied as a pair.

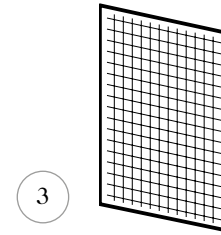

SWFTN, basic filter
Used as an alternative to the filter section. Provides the heating coil with basic protection. The filter is easily fitted into the SW unit and can be cleaned from either the top or bottom. The SWH unit has a re-usable filter (fig 3).

Accessories SWH12-33

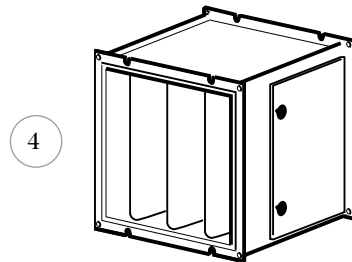

SWF, filter section
Fig. 4. Filters the outdoor air or/and return air from particles that might reduce the performance and reliability of SW. The disposable deep-pleated bagfilter is a cassette of synthetic material. Filterclass G85 (EU3). The filter section is equipped with filter on delivery.
Note! A return air intake (SWD) is required.

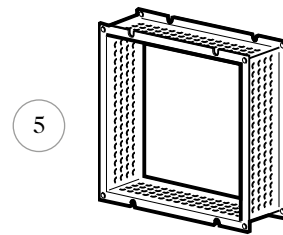

SWD, return air intake
Fig. 5. Allows air intake when filter section is used.

SWEF, extra filtercassette
Replacement filter for SWF.

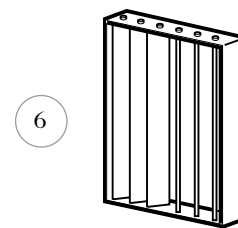
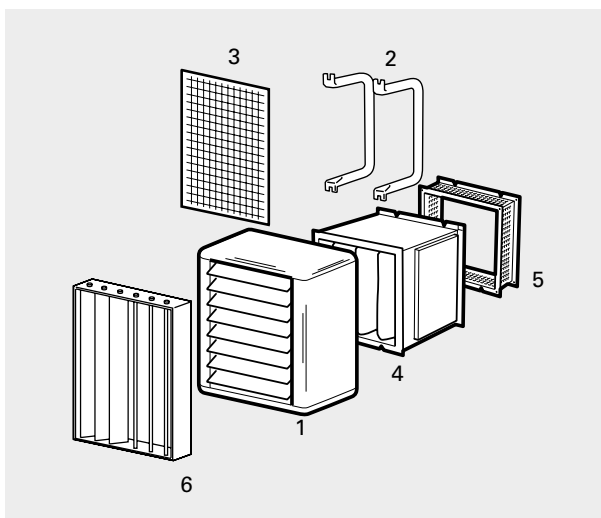

SWLR, extra air director
Fig. 6. To direct the air stream sideways. On delivery, SWH is equipped with an air director for vertical direction of the air stream. Individually adjustable louvres in anodised aluminium.
The extra air director is mounted to SWH by hooking it onto the existing air director.

Get In Touch

Call: 01729 824108
Email: info@puravent.co.uk

Our Address

Puravent, Adremit Limited, 6 County Business Park,
Darlington Road, Northallerton, DL6 2NQ



Fan heater SWH

Mounting and connection



Connection from the left



Connection from the right



Ceiling mounting

Mounting

The fan heaters can be permanently mounted on a wall for horizontal air distribution, or on the ceiling for vertical air distribution. The accessories are assembled with screws or guides and then fitted to the wall or ceiling with suitable fasteners. Mounting brackets are extra.

Connection of heating coil

By turning the fan heater, pipe connections are possible on both sides. Heating coil with copper pipes. Smooth pipe connections for soldering or compression fittings. A vent valve should be connected at a high point in the pipe system. Vent- and draining valves are not included in the heating coil. For correct inlet and outlet connection of the heating coil, see dimension sketch.

Connection

The fan motor is connected via the integrated PC board (SIRe) that is located on the unit.

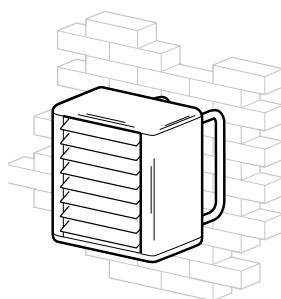

SWH fitted on a wall with mounting brackets

Mounting SWH

Mounting brackets SWB are to be ordered separately. A set of screws are included for fixing on the back side of SWH. The brackets are fitted on the wall or on the ceiling with suitable fasteners.

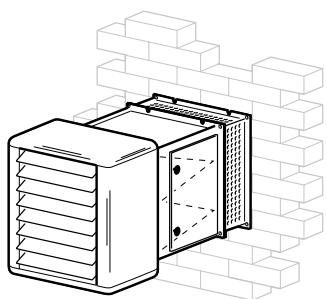

SWH with filter section and return air intake

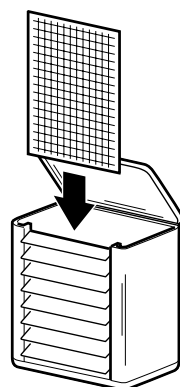

SWH with basic filter

Mounting SWH with filter section SWF



When a filter section is used, it must be attached to the return air intake (SWD) to allow for air intake.

Mounting basic filter SWFTN in SWH

This basic filter is very easy to fit into SWH. The top or bottom lid is opened, and the filter is pushed down behind the coil in tracks for this purpose.

For output charts, wiring diagrams and other technical information, please see the manual and www.frico.net.

Get In Touch

 Call: [01729 824108](tel:01729824108)
 Email: info@puravent.co.uk

Our Address

Puravent, Adremit Limited, 6 County Business Park,
Darlington Road, Northallerton, DL6 2NQ

Control SWH - SIRE control system

SWH is prepared for the SIRE control system whose pre-programmed default settings and many features make it easy to install and use the fan heater. The control system is pre-installed in SWH with an integrated PC board. If more than one SWH should be controlled by a single SIRE, an additional modular cable SIRECC per unit is needed. Cables between units can easily be joined together by using joint piece SIRECJ. SIRE is supplied pre-programmed with quick fit plug connections and is very easy to use and install.

SIRE learns the requirements and can provide fully automated room heating with calendar function and selectable switch off at set temperatures for up to nine units. Using SIRE no more energy is consumed than necessary. Because the fan speed is adapted, the sound level is optimized and is never higher than is necessary for comfort. With SIRE Advanced it is possible to choose between Eco and Comfort mode dependent on whether energy savings or optimal comfort has been prioritised.

SWH is delivered pre-programmed in Automatic control, fan position 4. For optimum performance of heat output and sound level, fan speeds up to step 4 are recommended. Fan position 5 is available in Manual control.

There are three different levels with different functionality to choose from, Basic, Competent or Advanced.

Functions SIREBN Basic

- Manual regulation of the fan and temperature
- Automatic control of fan speed and temperature with integrated thermostat.

Functions SIREFCY Competent

- All functions for Basic
- Calendar function
- Filter alarm
- Simple BMS control - on/off, fan speed and alarm functions
- Possibility to change preset values for each fan step (SWH EC).

Functions SIREFAY Advanced

- All functions for Competent
- Eco mode - extra energy-efficient mode
- Comfort mode - when comfort is important
- Advanced BMS control
- Max limit of return water temperature.
- Stepless heat control.
- Possibility to use an external filter guard.

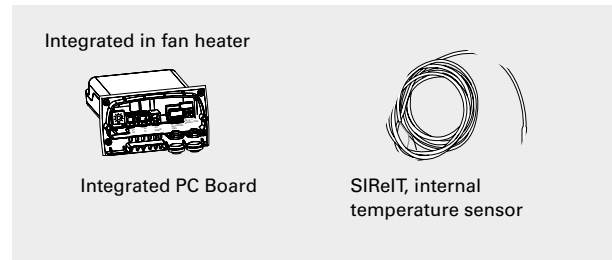

Type	Description
SIREBN	Control system SIRE Basic
SIREFCY	Control system SIRE Competent for fan heaters
SIREFAY	Control system SIRE Advanced for fan heaters
SIRERTX	External room temperature sensor
SIREUR	Kit for recessed installation
SIREWTA	Clamp-on sensor
SIRECC603	Modular cable RJ12 (6/6) 3 m
SIRECC605	Modular cable RJ12 (6/6) 5 m
SIRECC610	Modular cable RJ12 (6/6) 10 m
SIRECC615	Modular cable RJ12 (6/6) 15 m
SIRECC640	Modular cable RJ12 (6/6) 40 m

Basic - SIREBN - Simple and low cost

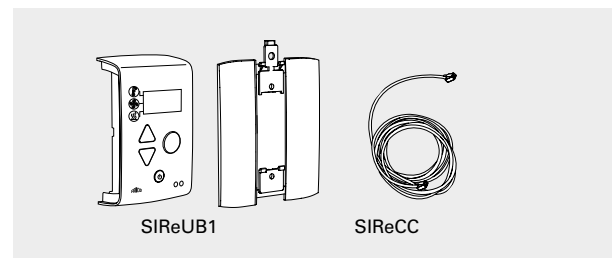

Manual or automatic control of fan speed and temperature with an integrated thermostat. Possibility of selecting whether the fan should be switched off or not at set room temperature, depending whether sound comfort or circulation of room air is prioritised. Alarm via control unit.

Included in SIREBN Basic:

- SIREUB1, control unit with built in room temperature sensor. Wall unit cover included.
- SIRECC, modular cable, RJ12 (6p/6c), 5 m

Accessories

- SIRERTX, external room temperature sensor, RJ11 (4p/4c), 10 m
- SIRECC, modular cable, RJ12 (6p/6c), 5, 10, 15, 40 m
- VLSP, pressure independent valve system on/off

Get In Touch

Call: [01729 824108](tel:01729824108)
 Email: info@puravent.co.uk

Our Address

Puravent, Adremit Limited, 6 County Business Park,
 Darlington Road, Northallerton, DL6 2NQ

Fan heater SWH

Competent - SIREFCY - Extended functionality

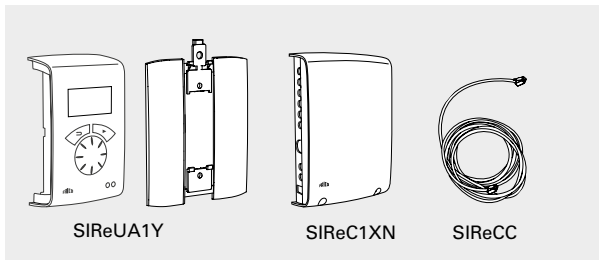

Manual or automatic control of fan speed and temperature with an integrated thermostat. Possibility of selecting whether the fan should be switched off or not at set room temperature, depending whether sound comfort or circulation of room air is prioritised. Possibility to change preset values for each fan step (SWH EC).

Calendar function with weekly program and night mode. Filter alarm that indicates when it is time to change or clean the filter. With SIREUR the control unit can be recessed in a wall, protruding only 11 mm. Alarm via control unit or BMS.

Included in SIREFCY Competent:

- SIREUA1Y, control unit with built in room temperature sensor. Wall unit cover included.
- SIREC1XN, PC board HUB Competent
- SIRECC, modular cables, RJ12 (6p/6c), 3 m resp. 5 m

Accessories

- SIRERTX, external room temperature sensor, RJ11 (4p/4c), 10 m
- SIREUR, kit for recessed installation
- SIRECC, modular cable, RJ12 (6p/6c), 5, 10, 15, 40 m
- VLSP, pressure independent valve system on/off

Advanced - SIREFAY - fully automatic with extended functionality

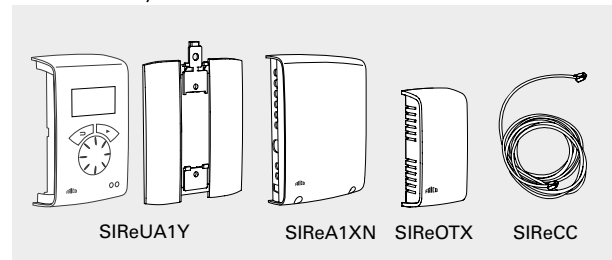

Manual or automatic control of fan speed and temperature with an integrated thermostat. Possibility of selecting whether the fan should be switched off or not at set room temperature, depending whether sound comfort or circulation of room air is prioritised. Possibility to change preset values for each fan step (SWH EC).

Calendar function with weekly program and night mode. Filter alarm that indicates when it is time to change or clean the filter. With SIREUR the control unit can be recessed in a wall, protruding only 11 mm. Alarm via control unit or BMS.

Possible to control and monitor using BMS system. Choose between Eco and Comfort mode dependent on whether energy savings or optimal comfort has been prioritised. Valve system VLP is required to use SIRE Advanced.

Included in SIREFAY Advanced:

- SIREUA1Y, control unit with built in room temperature sensor. Wall unit cover included.
- SIREA1XN, PC board HUB Advanced
- SIREOTX, outdoor temperature sensor
- SIRECC, modular cables, RJ12 (6p/6c), 3 m resp. 5 m

Accessories

- SIRERTX, external room temperature sensor, RJ11 (4p/4c), 10 m
- SIREUR, kit for recessed installation
- SIREWTA, return water sensor, RJ11 (4p/4c), 3 m
- SIRECC, modular cable, RJ12 (6p/6c), 5, 10, 15, 40 m
- VLP, pressure independent and modulating valve system



Get In Touch

- Call: 01729 824108
Email: info@puravent.co.uk

Our Address

Puravent, Adremit Limited, 6 County Business Park,
Darlington Road, Northallerton, DL6 2NQ

SIRe control system - options

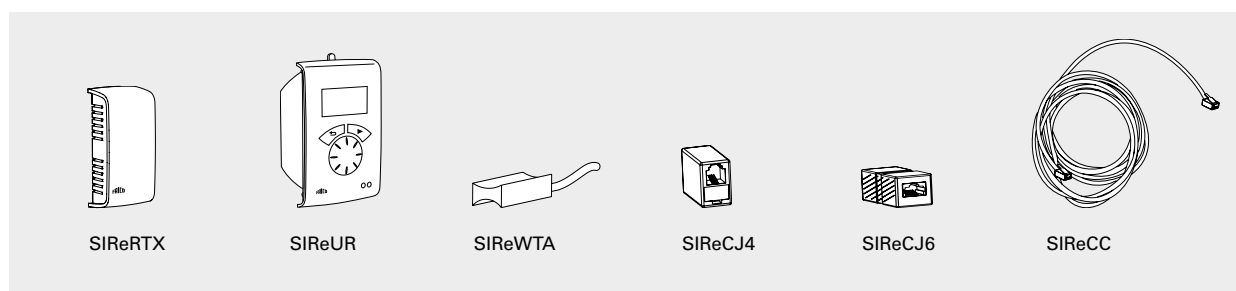

SIReRTX, external room temperature sensor
Used to obtain a better measuring point in the premises when the control unit is located so that the internal room temperature sensor does not show a relevant value. 10 m. cable with modular connector RJ11 (4p/4c).

SIReUR, kit for recessed installation
Kit for installing SIReUA1 recessed in a wall. Only protrudes 11 mm from the wall.

SIReWTA, return water sensor
Clamp-on sensor for return water temperature control. 3 m. cable with modular connector RJ11 (4p/4c). Should be mounted on the return pipe on the heating coil.

SIReCJ4/SIReCJ6, joint piece
Used to join two RJ11 (4p/4c) respectively RJ12 (6p/6c).

SIReCC, modular cables
Modular cables RJ11 (4p/4c) and RJ12 (6p/6c). Available in lengths of 3, 5, 10 and 15 m (RJ12 also in 40 m).

Type	Description
SIReRTX	External room temperature sensor, NTC10KΩ
SIReUR	Kit for recessed installation IP30
SIReWTA	Return water sensor RJ11 (4p/4c) 3 m IP65
SIReCJ4	Used to join two RJ11 (4/4)
SIReCJ6	Used to join two RJ12 (6/6)
SIReCC603	Modular cable RJ12 (6/6) 3 m
SIReCC605	Modular cable RJ12 (6/6) 5 m
SIReCC610	Modular cable RJ12 (6/6) 10 m
SIReCC615	Modular cable RJ12 (6/6) 15 m
SIReCC640	Modular cable RJ12 (6/6) 40 m
SIReCC403	Modular cable RJ11 (4/4) 3 m
SIReCC405	Modular cable RJ11 (4/4) 5 m
SIReCC410	Modular cable RJ11 (4/4) 10 m
SIReCC415	Modular cable RJ11 (4/4) 15 m

Get In Touch

Call: [01729 824108](tel:01729824108)
Email: info@puravent.co.uk

Our Address

Puravent, Adremit Limited, 6 County Business Park,
Darlington Road, Northallerton, DL6 2NQ

Fan heater SWH

Water control

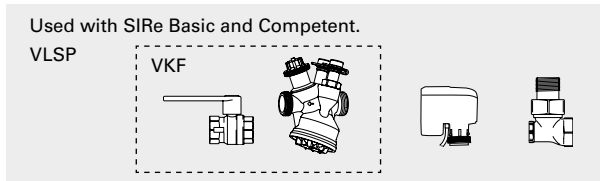

VLSP, pressure independent valve system on/off
Two way pressure independent control and adjustment valve with on/off actuator, shut-off valve and bypass.
DN15/20/25/32. 230V.

The valve system VLSP consists of the following:

- VKF, valve kit
 - TAC, pressure independent regulation and adjustment valve
 - AV, shut off valve
- SD230, actuator on/off 230V
- BPV10, bypass valve

Type	DN	Flow range l/s
VLSP15LF	DN15	0,012 - 0,068
VLSP15NF	DN15	0,024 - 0,131
VLSP20	DN20	0,058 - 0,319
VLSP25	DN25	0,103 - 0,597
VLSP32	DN32	0,222 - 1,028

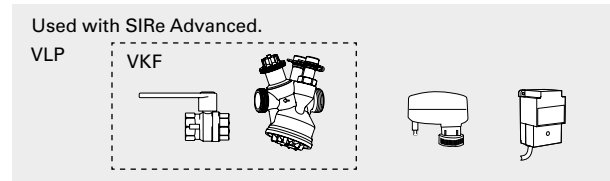

VLP, pressure independent and modulating valve system

Two way pressure independent control and adjustment valve with modulating actuator and shut-off valve.
DN15/20/25/32. 24V.

The valve system VLP consists of the following:

- VKF, valve kit
 - TAC, pressure independent regulation and adjustment valve
 - AV, shut off valve
- SDM24, modulating actuator 24V
- ST23024, 24V transformer for 1-7 actuators

Type	DN	Flow range l/s
VLP15LF	DN15	0,012 - 0,068
VLP15NF	DN15	0,024 - 0,131
VLP20	DN20	0,058 - 0,319
VLP25	DN25	0,103 - 0,597
VLP32	DN32	0,222 - 1,028

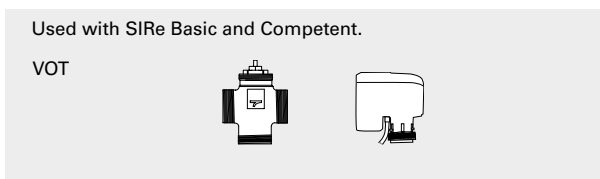

VOT, three way control valve and actuator on/off
3-way control valve with on/off actuator, DN15/20/25.
230V.

The valve kit consists of the following:

- TRVS, 3-way control valve
- SD230, actuator on/off 230V

Type	DN	Kvs	Max flow at 10 kPa
VOT15	DN15	1,7	0,149
VOT20	DN20	2,5	0,220
VOT25	DN25	4,5	0,395

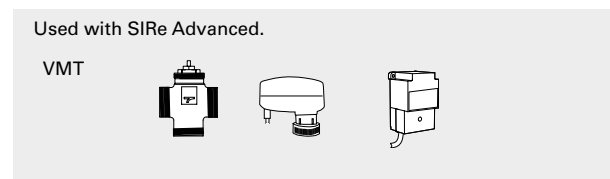

VMT, three way control valve and modulating actuator

3-way control valve with modulating actuator.
DN15/20/25. 24V.

The valve kit consists of the following:

- TRVS, 3-way control valve
- SDM24, modulating actuator 24V
- ST23024, 24V transformer for 1-7 actuators

Type	DN	Kvs	Max flow at 10 kPa
VMT15	DN15	1,7	0,149
VMT20	DN20	2,5	0,220
VMT25	DN25	4,5	0,395

Get In Touch

Call: 01729 824108
Email: info@puravent.co.uk

Our Address

Puravent, Adremit Limited, 6 County Business Park,
Darlington Road, Northallerton, DL6 2N0