

Before using your air conditioner, please read this manual carefully and keep it for future reference.

WINDOW/WALL-TYPE ROOM AIR CONDITIONER

USER'S MANUAL

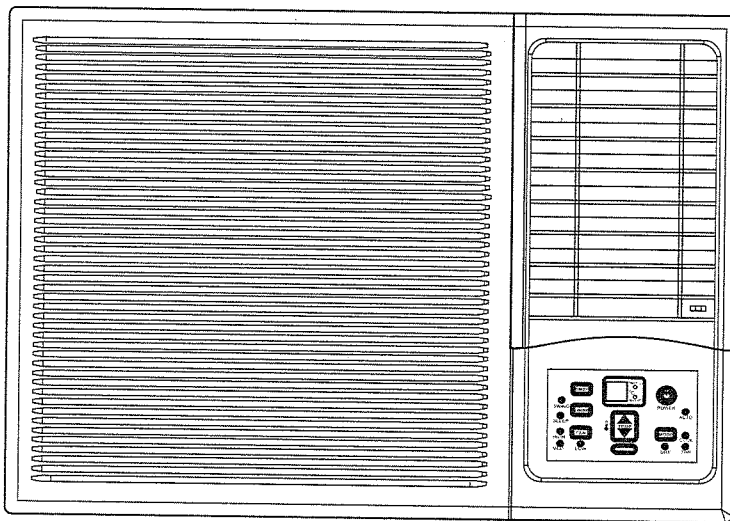

Prior to installation this air-conditioning unit must be submitted for approval by the utility service which provides electricity.

Get In Touch

 Call: 0845 6880112
 Email: info@adremit.co.uk

Our Address

Puravent, Adremit Limited, Unit 5a, Commercial Yard,
Settle, North Yorkshire, BD24 9RH



CONTENTS

- 1. SAFETY PRECAUTIONS.....2
- 2. UNIT PARTS IDENTIFICATION.....14
- 3. OPERATING INSTRUCTIONS15
- 4. INSTALLATION INSTRUCTIONS.....20
- 5. TROUBLESHOOTING23
- 6. SPECIFICATIONS24

Read This Manual

Inside you will find many helpful hints on how to use and maintain your air conditioner properly. Just a little preventive care on your part can save you a great deal of time and money over the life of your air conditioner. You'll find many answers to common problems in the chart of troubleshooting tips. If you review our chart of Troubleshooting Tips first, you may not need to call for service at all.

SOCIABLE REMARK

When using this unit in the European countries, the following information must be followed:

DISPOSAL: Do not dispose this product as unsorted municipal waste. Collection of such waste separately for special treatment is necessary.

It is prohibited to dispose of this appliance in domestic household waste.

For disposal, there are several possibilities:

- A) The municipality has established collection systems, where electronic waste can be disposed of at least free of charge to the user.
- B) When buying a new product, the retailer will take back the old product at least free of charge.
- C) The manufacturer will take back the old appliance for disposal at least free of charge to the user.
- D) As old products contain valuable resources, they can be sold to scrap metal dealers.

Wild disposal of waste in forests and landscapes endangers your health when hazardous substances leak into the ground-water and find their way into the food chain.

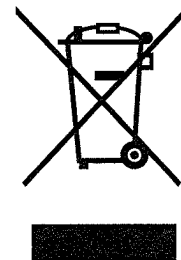

Get In Touch

Call: 0845 6880112
 Email: info@adremit.co.uk



Our Address

Puravent, Adremit Limited, Unit 5a, Commercial Yard,
 Settle, North Yorkshire, BD24 9RH



SAFETY PRECAUTIONS



To prevent injury to the user or other people and property damage, the following instructions must be followed. Incorrect operation due to ignoring of instructions may cause harm or damage. The seriousness is classified by the following indications.

 WARNING	This symbol indicates the possibility of death or serious injury.
 CAUTION	This symbol indicates the possibility of injury or damage to property.

WARNING

- Plug in power plug properly. Otherwise, it may cause electric shock or fire due to excess heat generation.
- Do not operate or stop the unit by inserting or pulling out the power plug. It may cause electric shock or fire due to heat generation.
- Do not damage or use an unspecified power cord. It may cause electric shock or fire. If the power cord is damaged, it must be replaced by the manufacturer or an authorised service centre or a similarly qualified person in order to avoid a hazard.
- Do not modify power cord length or share the outlet with other appliances. It may cause electric shock or fire due to heat generation.
- Do not operate with wet hands or in damp environment.
It may cause electric shock.
- Do not direct airflow at room occupants only. This could damage your health.
- Always ensure effective earthing. Incorrect earthing may cause electric shock.
- Do not allow water to run into electric parts.
It may cause failure of machine or electric shock.
- Always install circuit breaker and a dedicated power circuit.
Incorrect installation may cause fire and electric shock.
- Unplug the unit or disconnect the power supply to the unit, if strange sounds, smell, or smoke comes from it.
It may cause fire and electric shock.
- Do not use the socket if it is loose or damaged.
It may cause fire and electric shock.
- Do not open the unit during operation. It may cause electric shock.
- Leave the door closed while the air conditioner is running.
It is not designed to cool the entire house.

Get In Touch

 Call: 0845 6880112
 Email: info@adremit.co.uk

Our Address

Puravent, Adremit Limited, Unit 5a, Commercial Yard,
Settle, North Yorkshire, BD24 9RH

- Do not use the power cord close to heating appliances.
It may cause fire and electric shock.
- Do not use the power cord near flammable gas or combustibles, such as gasoline, benzene, thinner, etc. It may cause an explosion or fire.
- Ventilate room before operating air conditioner if there is a gas leakage from another appliance.
It may cause explosion, fire and burns.
- Do not disassemble or modify unit. It may cause failure and electric shock.

CAUTION

- When the air filter is to be removed, do not touch the metal parts of the unit.
It may cause an injury.
- Do not clean the air conditioner with water.
Water may enter the unit and degrade the insulation. It may cause an electric shock.
- Ventilate the room well when used together with a stove, etc.
An oxygen shortage may occur.
- When the unit is to be cleaned, switch off, and turn off the circuit breaker.
Do not clean unit when power is on as it may cause fire and electric shock, it may cause an injury.
- Do not put a pet or house plant where it will be exposed to direct air flow.
This could injure the pet or plant.
- Do not use for special purposes. Do not use this air conditioner to preserve precision devices, food, pets, plants, and art objects.
It may cause deterioration of quality, etc.
- Stop operation and close the window in storm or hurricane.
Operation with windows opened may cause wetting of indoor and soaking of household furniture.
- Hold the plug by the head of the power plug when taking it out.
It may cause electric shock and damage.
- Turn off the main power switch when not using the unit for a long time.
It may cause failure of product or fire.
- Do not place obstacles around air-inlets or inside of air-outlet.
It may cause failure of appliance or accident.
- Always insert the filters securely. Clean filter once every two weeks.
Operation without filters may cause failure.

Get In Touch

 Call: 0845 6880112
 Email: info@adremit.co.uk

Our Address

Puravent, Adremit Limited, Unit 5a, Commercial Yard,
Settle, North Yorkshire, BD24 9RH

- Ensure that the installation bracket of the outdoor appliance is not damaged due to prolonged exposure. If bracket is damaged, there is concern of damage due to falling of unit.
- Do not use strong detergent such as wax or thinner but use a soft cloth. Appearance may be deteriorated due to change of product color or scratching of its surface.
- Do not place heavy object on the power cord and ensure that the cord is not compressed. There is danger of fire or electric shock.
- Do not drink water drained from air conditioner. It contains contaminants and could make you sick.
- Use caution when unpacking and installing. Sharp edges could cause injury.
- If water enters the unit, turn the unit off at the power outlet and switch off the circuit breaker. Isolate supply by taking the power-plug out or disconnect the power supply to the unit, and contact a qualified service technician.
- This appliance can be used by children aged from 8 years and above and persons with reduced physical, sensory or mental capabilities or lack of experience and knowledge if they have been given supervision or instruction concerning use of the appliance in a safe way and understand the hazards involved. Children shall not play with the appliance. Cleaning and user maintenance shall not be made by children without supervision. (be applicable for the European Countries)
- This appliance is not intended for use by persons (including children) with reduced physical ,sensory or mental capabilities or lack of experience and knowledge, unless they have been given supervision or instruction concerning use of the appliance by a person responsible for their safety. (be applicable for other countries except the European Countries)
- Children should be supervised to ensure that they do not play with the appliance.
- If the supply cord is damaged, it must be replaced by the manufacturer, its service agent or similarly qualified persons in order to avoid a hazard.
- The appliance shall be installed in accordance with national wiring regulations.

Get In Touch

 Call: [0845 6880112](tel:08456880112)
 Email: info@adremit.co.uk

Our Address

Puravent, Adremit Limited, Unit 5a, Commercial Yard,
 Settle, North Yorkshire, BD24 9RH

- Do not operate your air conditioner in a wet room such as a bathroom or laundry room.
- The appliance with electric heater shall have at least 1 meter space to the combustible materials.
- Contact the authorised service technician for repair or maintenance of this unit.
- Contact the authorised installer for installation of this unit.
- When there are wide differences between “USER’S MANUAL” and “Remote controller Illustration” on function description, the description on “USER’S MANUAL” shall prevail.
- If the air conditioner is knocked over during use, turn off the unit and unplug it from the main power supply or disconnect the power supply to the unit, immediately. Visually inspect the unit to ensure there is
- no damage.
If you suspect the unit has been damaged, contact a technician or customer service for assistance.
- In a thunderstorm, the power must be cut off to avoid damage to the machine due to lightning.
To reduce the risk of fire or electric shock, do not use this fan with
- any solid-state speed control device.
Do not run cord under carpeting. Do not cover cord with throw rugs, runners, or similar coverings. Do not route cord under furniture or appliances. Arrange cord away from traffic area and where it will
- not be tripped over.
If connecting power to fixed wiring, an all-pole disconnection device which has at least 3mm clearances in all poles, and have a leakage current that may exceed 10mA, the residual current device(RCD) having a rated residual operating current not exceeding 30mA, and disconnection must be incorporated in the
- fixed wiring in accordance with the wiring rules.
How to fix the appliance to its support, please read the “installation instructions” section in this manual.
- All wiring must be performed strictly in accordance with the wiring diagram located inside of the unit.
- The unit’s circuit board(PCB) is designed with a fuse to provide overcurrent protection. The specifications of the fuse are printed on the circuit board, such as: T 3.15A/250V, etc.

Get In Touch

 Call: 0845 6880112
 Email: info@adremit.co.uk

Our Address

Puravent, Adremit Limited, Unit 5a, Commercial Yard,
 Settle, North Yorkshire, BD24 9RH



SAFETY PRECAUTIONS(prior to operation)

Preparing for operation

1. Contact an installation specialist for installation.
2. Plug in the power plug properly.
3. Do not use a damaged or non-standard power cord.
4. Do not share the same outlet with other appliances.
5. Do not use an extension cord.
6. Do not start/stop operation by plugging/unplugging the power cord.



Usage

1. Exposure to direct airflow for an extended period of time could be hazardous to your health. Do not expose occupants, pets, or plants to direct airflow for extended periods of time.
2. Due to the possibility of oxygen deficiency, ventilate the room when used together with stoves or other heating devices.
3. Do not use this air conditioner for non-specified special purposes (e.g. Preserving precision devices, food, pets, plants, and art objects). Usage in such a manner could harm such property.

Cleaning and maintenance

1. Do not touch the metal parts of the unit when removing the filter. Injuries can occur when handling sharp metal edges.
2. Do not use water to clean inside the air conditioner. Exposure to water can destroy the insulation, leading to possible electric shock.
3. When cleaning and maintenance the unit, first make sure that the power and circuit breaker are turned off.

Get In Touch

 Call: 0845 6880112
 Email: info@adremit.co.uk

Our Address

Puravent, Adremit Limited, Unit 5a, Commercial Yard,
Settle, North Yorkshire, BD24 9RH

Operating Temperature

Cooling operation	Outdoor temp:	18-43°C/64-109°F (18-52°C/64-125°F for special tropical models)
	Indoor temp:	17-32°C/62-90°F
Heating operation	Outdoor temp:	-5-24°C/23-76°F
	Indoor temp:	0-27°C/32-80°F

Note: Performance may be reduced outside of these operating temperatures.

Auto-Restart(on some models)

If the unit breaks off unexpectedly due to the power cut, it will restart with the previous function setting automatically when the power resumes.

Wait 3 minutes before resuming operation

After the unit has stopped, it can not be restarted operation in the first 3 minutes. This is to protect the unit. Operation will automatically start after 3 minutes.

CAUTION: Before installing, remove all packaging from inside the carton, along with any inserts placed into the side louvers.

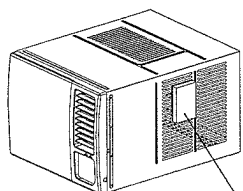

Inserts placed into the side louvers.

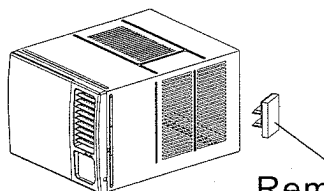

Remove inserts placed into the side louvers.

Note About Fluorinated Gasses

- Fluorinated greenhouse gases are contained in hermetically sealed equipment. For specific information on the type, the amount and the CO₂ equivalent in tonnes of the fluorinated greenhouse gas (on some models), please refer to the relevant label on the unit itself.
- Installation, service, maintenance and repair of this unit must be performed by a certified technician.
- Product uninstallation and recycling must be performed by a certified technician.

Get In Touch

Call: 0845 6880112
Email: info@adremit.co.uk

Our Address

Puravent, Adremit Limited, Unit 5a, Commercial Yard, Settle, North Yorkshire, BD24 9RH

SAFETY PRECAUTIONS

⚠️ WARNINGS (for using R290/R32 refrigerant only)

- Do not use means to accelerate the defrosting process or to clean, other than those recommended by the manufacturer.
- The appliance shall be stored in a room without continuously operating ignition sources (for example: open flames, an operating gas appliance or an operating electric heater).
- Do not pierce or burn.
- Be aware that the refrigerants may not contain an odour.
- Appliance should be installed, operated and stored in a room with a floor area larger than 4 m².
- Compliance with national gas regulations shall be observed.
- Keep ventilation openings clear of obstruction.
- The appliance shall be stored so as to prevent mechanical damage from occurring.
- A warning that the appliance shall be stored in a well-ventilated area where the room size corresponds to the room area as specified for operation.
- Any person who is involved with working on or breaking into a refrigerant circuit should hold a current valid certificate from an industry-accredited assessment authority, which authorises their competence to handle refrigerants safely in accordance with an industry recognised assessment specification.
- Servicing shall only be performed as recommended by the equipment manufacturer. Maintenance and repair requiring the assistance of other skilled personnel shall be carried out under the supervision of the person competent in the use of flammable refrigerants.





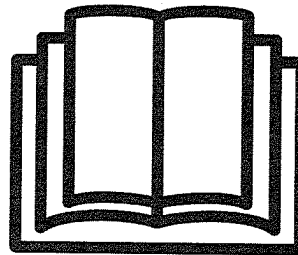

Caution: Risk of fire/
flammable materials
(Required for R32/R290 units only)





IMPORTANT NOTE: Read this manual carefully before installing or operating your new air conditioning unit. Make sure to save this manual for future reference.

Explanation of symbols displayed on the unit (For the unit adopts R32/R290 Refrigerant only):

	WARNING	This symbol shows that this appliance used a flammable refrigerant. If the refrigerant is leaked and exposed to an external ignition source, there is a risk of fire.
	CAUTION	This symbol shows that the operation manual should be read carefully.
	CAUTION	This symbol shows that a service personnel should be handling this equipment with reference to the installation manual.
	CAUTION	This symbol shows that information is available such as the operating manual or installation manual.

Get In Touch

 Call: 0845 6880112
 Email: info@adremit.co.uk

Our Address

Puravent, Adremit Limited, Unit 5a, Commercial Yard,
Settle, North Yorkshire, BD24 9RH

SAFETY PRECAUTIONS

⚠ WARNINGS (for using R290/R32 refrigerant only)

1. Transport of equipment containing flammable refrigerants

See transport regulations

2. Marking of equipment using signs

See local regulations

3. Disposal of equipment using flammable refrigerants

See national regulations.

4. Storage of equipment/appliances

The storage of equipment should be in accordance with the manufacturer's instructions.

5. Storage of packed (unsold) equipment

Storage package protection should be constructed such that mechanical damage to the equipment inside the package will not cause a leak of the refrigerant charge.

The maximum number of pieces of equipment permitted to be stored together will be determined by local regulations.

6. Information on servicing

1) Checks to the area

Prior to beginning work on systems containing flammable refrigerants, safety checks are necessary to ensure that the risk of ignition is minimised. For repair to the refrigerating system, the following precautions shall be complied with prior to conducting work on the system.

2) Work procedure

Work shall be undertaken under a controlled procedure so as to minimise the risk of a flammable gas or vapour being present while the work is being performed.

3) General work area

All maintenance staff and others working in the local area shall be instructed on the nature of work being carried out. Work in confined spaces shall be avoided. The area around the workspace shall be sectioned off. Ensure that the conditions within the area have been made safe by control of flammable material.

4) Checking for presence of refrigerant

The area shall be checked with an appropriate refrigerant detector prior to and during work, to ensure the technician is aware of potentially flammable atmospheres. Ensure that the leak detection equipment being used is suitable for use with flammable refrigerants, i.e. non-sparking, adequately sealed or intrinsically safe.



5) Presence of fire extinguisher

If any hot work is to be conducted on the refrigeration equipment or any associated parts, appropriate fire extinguishing equipment shall be available to hand. Have a dry powder or CO2 fire extinguisher adjacent to the charging area.

6) No ignition sources

No person carrying out work in relation to a refrigeration system which involves exposing any pipe work that contains or has contained flammable refrigerant shall use any sources of ignition in such a manner that it may lead to the risk of fire or explosion. All possible ignition sources, including cigarette smoking, should be kept sufficiently far away from the site of installation, repairing, removing and disposal, during which flammable refrigerant can possibly be released to the surrounding space. Prior to work taking place, the area around the equipment is to be surveyed to make sure that there are no flammable hazards or ignition risks. No Smoking signs shall be displayed.

Get In Touch

 **Call:** 0845 6880112
 **Email:** info@adremit.co.uk

Our Address

Puravent, Adremit Limited, Unit 5a, Commercial Yard,
Settle, North Yorkshire, BD24 9RH

SAFETY PRECAUTIONS

7) Ventilated area

Ensure that the area is in the open or that it is adequately ventilated before breaking into the system or conducting any hot work. A degree of ventilation shall continue during the period that the work is carried out. The ventilation should safely disperse any released refrigerant and preferably expel it externally into the atmosphere.

8) Checks to the refrigeration equipment

Where electrical components are being changed, they shall be fit for the purpose and to the correct specification. At all times the manufacturer's maintenance and service guidelines shall be followed. If in doubt consult the manufacturer's technical department for assistance.

The following checks shall be applied to installations using flammable refrigerants:

The charge size is in accordance with the room size within which the refrigerant containing parts are installed;

The ventilation machinery and outlets are operating adequately and are not obstructed;

If an indirect refrigerating circuit is being used, the secondary circuit shall be checked for the presence of refrigerant;

Marking to the equipment continues to be visible and legible. Markings and signs that are illegible shall be corrected;

Refrigeration pipe or components are installed in a position where they are unlikely to be exposed to any substance which may corrode refrigerant containing components, unless the components are constructed of materials which are inherently resistant to being corroded or are suitably protected against being so corroded.

9) Checks to electrical devices

Repair and maintenance to electrical components shall include initial safety checks and component inspection procedures. If a fault exists that could compromise safety, then no electrical supply shall be connected to the circuit until it is satisfactorily dealt with. If the fault cannot be corrected immediately but it is necessary to continue operation, an adequate temporary solution shall be used. This shall be reported to the owner of the equipment so all parties are advised.

Initial safety checks shall include:

That capacitors are discharged: this shall be done in a safe manner to avoid possibility of sparking;

That there no live electrical components and wiring are exposed while charging, recovering or purging the system;

That there is continuity of earth bonding.

7. Repairs to sealed components



1) During repairs to sealed components, all electrical supplies shall be disconnected from the equipment being worked upon prior to any removal of sealed covers, etc. If it is absolutely necessary to have an electrical supply to equipment during servicing, then a permanently operating form of leak detection shall be located at the most critical point to warn of a potentially hazardous situation.

2) Particular attention shall be paid to the following to ensure that by working on electrical components, the casing is not altered in such a way that the level of protection is affected. This shall include damage to cables, excessive number of connections, terminals not made to original specification, damage to seals, incorrect fitting of glands, etc.

Ensure that apparatus is mounted securely.

Ensure that seals or sealing materials have not degraded such that they no longer serve the purpose of

Get In Touch

 Call: 0845 6880112
 Email: info@adremit.co.uk

Our Address

Puravent, Adremit Limited, Unit 5a, Commercial Yard,
Settle, North Yorkshire, BD24 9RH

SAFETY PRECAUTIONS

preventing the ingress of flammable atmospheres. Replacement parts shall be in accordance with the manufacturer's specifications.

NOTE: The use of silicon sealant may inhibit the effectiveness of some types of leak detection equipment. Intrinsically safe components do not have to be isolated prior to working on them.

8.Repair to intrinsically safe components

Do not apply any permanent inductive or capacitance loads to the circuit without ensuring that this will not exceed the permissible voltage and current permitted for the equipment in use.

Intrinsically safe components are the only types that can be worked on while live in the presence of a flammable atmosphere. The test apparatus shall be at the correct rating.

Replace components only with parts specified by the manufacturer. Other parts may result in the ignition of refrigerant in the atmosphere from a leak.

9.Cablling

Check that cabling will not be subject to wear, corrosion, excessive pressure, vibration, sharp edges or any other adverse environmental effects. The check shall also take into account the effects of aging or continual vibration from sources such as compressors or fans.

10.Detection of flammable refrigerants

Under no circumstances shall potential sources of ignition be used in the searching for or detection of refrigerant leaks. A halide torch (or any other detector using a naked flame) shall not be used.

11.Leak detection methods

The following leak detection methods are deemed acceptable for systems containing flammable refrigerants. Electronic leak detectors shall be used to detect flammable refrigerants, but the sensitivity may not be adequate, or may need re-calibration. (Detection equipment shall be calibrated in a refrigerant-free area.) Ensure that the detector is not a potential source of ignition and is suitable for the refrigerant used. Leak detection equipment shall be set at a percentage of the LFL of the refrigerant and shall be calibrated to the refrigerant employed and the appropriate percentage of gas (25 % maximum) is confirmed. Leak detection fluids are suitable for use with most refrigerants but the use of detergents containing chlorine shall be avoided as the chlorine may react with the refrigerant and corrode the copper pipe-work. If a leak is suspected, all naked flames shall be removed/ extinguished. If a leakage of refrigerant is found which requires brazing, all of the refrigerant shall be recovered from the system, or isolated (by means of shut off valves) in a part of the system remote from the leak. Oxygen free nitrogen (OFN) shall then be purged through the system both before and during the brazing process.

12.Removal and evacuation

When breaking into the refrigerant circuit to make repairs or for any other purpose conventional procedures shall be used. However, it is important that best practice is followed since flammability is a consideration. The following procedure shall be adhered to:

- Remove refrigerant;
- Purge the circuit with inert gas;
- Evacuate;
- Purge again with inert gas;
- Open the circuit by cutting or brazing.

Get In Touch

 Call: 0845 6880112
 Email: info@adremit.co.uk

Our Address

Puravent, Adremit Limited, Unit 5a, Commercial Yard,
Settle, North Yorkshire, BD24 9RH

SAFETY PRECAUTIONS

The refrigerant charge shall be recovered into the correct recovery cylinders. The system shall be flushed with OFN to render the unit safe. This process may need to be repeated several times. Compressed air or oxygen shall not be used for this task.

Flushing shall be achieved by breaking the vacuum in the system with OFN and continuing to fill until the working pressure is achieved, then venting to atmosphere, and finally pulling down to a vacuum. This process shall be repeated until no refrigerant is within the system. When the final OFN charge is used, the system shall be vented down to atmospheric pressure to enable work to take place. This operation is absolutely vital if brazing operations on the pipe-work are to take place.

Ensure that the outlet for the vacuum pump is not close to any ignition sources and there is ventilation available.

13. Charging procedures

In addition to conventional charging procedures, the following requirements shall be followed. Ensure that contamination of different refrigerants does not occur when using charging equipment. Hoses or lines shall be as short as possible to minimise the amount of refrigerant contained in them.

Cylinders shall be kept upright.

Ensure that the refrigeration system is earthed prior to charging the system with refrigerant. Label the system when charging is complete (if not already).

Extreme care shall be taken not to overfill the refrigeration system.



Prior to recharging the system it shall be pressure tested with OFN. The system shall be leak tested on completion of charging but prior to commissioning. A follow up leak test shall be carried out prior to leaving the site.

14. Decommissioning

Before carrying out this procedure, it is essential that the technician is completely familiar with the equipment and all its detail. It is recommended good practice that all refrigerants are recovered safely. Prior to the task being carried out, an oil and refrigerant sample shall be taken in case analysis is required prior to re-use of reclaimed refrigerant. It is essential that electrical power is available before the task is commenced.

- a) Become familiar with the equipment and its operation.
- b) Isolate system electrically.
- c) Before attempting the procedure ensure that:
 - Mechanical handling equipment is available, if required, for handling refrigerant cylinders;
 - All personal protective equipment is available and being used correctly;
 - The recovery process is supervised at all times by a competent person;
 - Recovery equipment and cylinders conform to the appropriate standards.
- d) Pump down refrigerant system, if possible.
- e) If a vacuum is not possible, make a manifold so that refrigerant can be removed from various parts of the system.
- f) Make sure that cylinder is situated on the scales before recovery takes place.
- g) Start the recovery machine and operate in accordance with manufacturer's instructions.
- h) Do not overfill cylinders. (No more than 80 % volume liquid charge).
- i) Do not exceed the maximum working pressure of the cylinder, even temporarily.
- j) When the cylinders have been filled correctly and the process completed, make sure that the cylinders and

Get In Touch

 Call: 0845 6880112
 Email: info@adremit.co.uk

Our Address

Puravent, Adremit Limited, Unit 5a, Commercial Yard,
Settle, North Yorkshire, BD24 9RH

SAFETY PRECAUTIONS

the equipment are removed from site promptly and all isolation valves on the equipment are closed off.

k) Recovered refrigerant shall not be charged into another refrigeration system unless it has been cleaned and checked.

15. Labelling

Equipment shall be labelled stating that it has been de-commissioned and emptied of refrigerant. The label shall be dated and signed. Ensure that there are labels on the equipment stating the equipment contains flammable refrigerant.

16. Recovery

When removing refrigerant from a system, either for servicing or decommissioning, it is recommended good practice that all refrigerants are removed safely.

When transferring refrigerant into cylinders, ensure that only appropriate refrigerant recovery cylinders are employed. Ensure that the correct number of cylinders for holding the total system charge is available. All cylinders to be used are designated for the recovered refrigerant and labelled for that refrigerant (i.e. special cylinders for the recovery of refrigerant). Cylinders shall be complete with pressure relief valve and associated shut-off valves in good working order. Empty recovery cylinders are evacuated and, if possible, cooled before recovery occurs.

The recovery equipment shall be in good working order with a set of instructions concerning the equipment that is at hand and shall be suitable for the recovery of flammable refrigerants.

In addition, a set of calibrated weighing scales shall be available and in good working order.

Hoses shall be complete with leak-free disconnect couplings and in good condition. Before using the recovery machine, check that it is in satisfactory working order, has been properly maintained and that any associated electrical components are sealed to prevent ignition in the event of a refrigerant release. Consult manufacturer if in doubt.

The recovered refrigerant shall be returned to the refrigerant supplier in the correct recovery cylinder, and the relevant Waste Transfer Note arranged. Do not mix refrigerants in recovery units and especially not in cylinders. If compressors or compressor oils are to be removed, ensure that they have been evacuated to an acceptable level to make certain that flammable refrigerant does not remain within the lubricant. The evacuation process shall be carried out prior to returning the compressor to the suppliers. Only electric heating to the compressor body shall be employed to accelerate this process. When oil is drained from a system, it shall be carried out safely.

Get In Touch

 Call: [0845 6880112](tel:08456880112)
 Email: info@adremit.co.uk

Our Address

Puravent, Adremit Limited, Unit 5a, Commercial Yard,
Settle, North Yorkshire, BD24 9RH



UNIT PARTS IDENTIFICATION

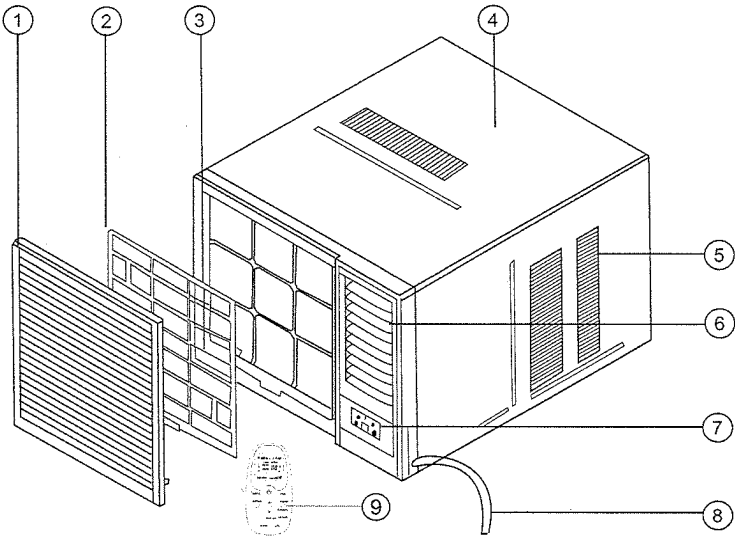

- 1. Front panel
- 2. Air filter
- 3. Frame
- 4. Cabinet
- 5. Air inlet grille (outdoor side)
- 6. Air outlet grille
- 7. Electronic control keypad
- 8. Power supply cord
- 9. Remote controller

1. Power cord conductors are distinguished according to color as follows (see Fig.a)
2. For your safety and protection, this unit is earthed through the power cord (see Fig.b)
Please contact the manufacturer or its service agent or a similar qualified person if you want to replace it.
3. Be sure that the unit being correctly grounded. The wall outlet (Air-break switch) should be provided with reliable earth wire.
4. The unit should be provided with an individual circuit and the circuit breaker/fuse rating should be the same as that of the power cord and wall outlet.

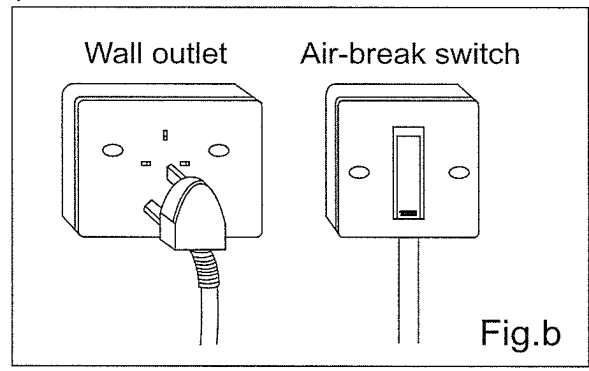
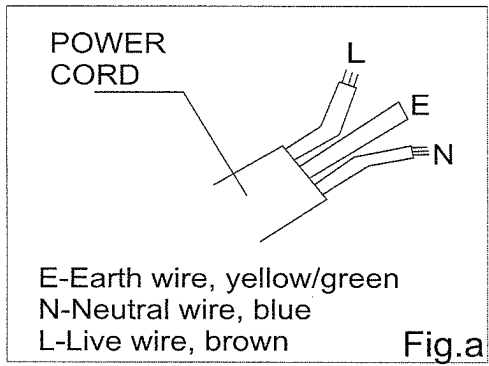

Accessories

Seal () (Used on drain joint)	Drain Joint()	Drain Tray ()	Wooden screw (optional)()	Rubber Plug	Screw
1 pc	1 pc	1 pc	8 pcs	1 pc or 2 pcs (depend on model you purchased)	2 pcs (For ≥18000Btu/h models only: Used to fasten the front panel) 2 pcs or 4 pcs (Used to install the drain tray)

NOTE: Optional parts (✕), depending on model you purchased.

NOTE:All the illustrations in the manual are for explanation purpose only.Your air conditioner may be slightly different. The actual shape shall prevail.

OPERATING INSTRUCTIONS

Controls

The electronic control keypad will look like one of the followings:

Reverse Cycle Models

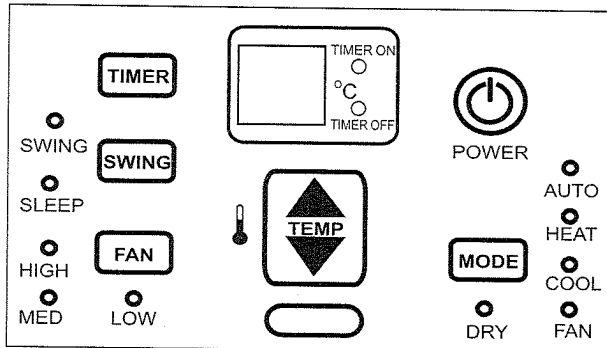

Cooling Only Models

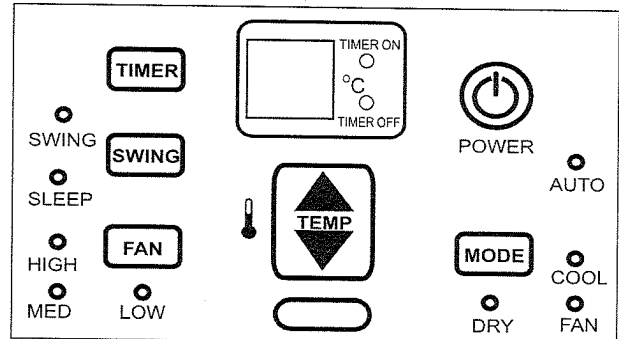

NOTE: The outline of the operation panel is based on typical model, the function is the same with your air conditioner while some difference may exist in appearance.

NOTE: Some models without MED fan speed feature and (or) AUTO mode feature and (or) swing feature.

Vent Control

The vent control is located above the control knobs. The operation method is different on different models (see the following figures).

For maximum cooling efficiency, CLOSE the vent. It will allow internal air circulation. OPEN the vent to discharge stale air.



CLOSE ← VENT → OPEN

To open the vent, pull the lever toward you
To close it, push it in.

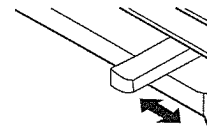

CLOSE ← OPEN

To open the vent, set the lever to the right position
To close it, set the lever to the left position.

POWER:

Press the POWER keypad to turn the unit on/off.

MODE:

Press the "MODE" keypad to select the appropriate operating mode. The mode selection will alternate between AUTO, HEAT (cooling only models without), COOL, FAN and DRY. The indicator light beside the "MODE" option will illuminate, identifying the mode selected.

NOTE:

Press the "MODE" keypad to select the FAN mode, you can press "FAN" keypad to select your desired fan speed but you can not adjust temperature.

▲ TEMPERATURE SETTINGS UP:

Press the ▲ keypad to increase the set (operating) temperature of the unit. Each time the keypad is pressed the temperature increases as follows: 1°C (Celsius Scale) Maximum Setting 30°C

▼ TEMPERATURE SETTINGS DOWN:

Press the ▼ keypad to decrease the set (operating) temperature of the unit. Each time the keypad is pressed the temperature decreases as follows: 1°C (Celsius Scale) Minimum Setting 17°C

FAN:

Press this keypad to activate the appropriate fan speed setting. Each depression of the keypad will alternate through LOW, MED (on some models), HIGH fan speed options. The indicator light beside the FAN speed option will illuminate, identifying the fan speed selected.

OPERATING INSTRUCTIONS(continued)

SWING:(on some models)

Press the "SWING" keypad to activate the automatic air swing feature. The indicator light adjacent to the "SWING" keypad will illuminate, identifying to the selected mode is operational. The vertical louvers will oscillate back and forth (side to side) automatically sweeping air alternately for comfortable cooling/heating. To stop the air swing feature, press the "SWING" keypad again, the indicator light adjacent to the keypad will go off.

TIMER:

- When the unit is on, press the Timer button will initiate the Auto stop program, the TIMER OFF indicator light illuminates. Press the UP or down button to select the desired time. Press the TIMER button again within 10 seconds, the Auto start program is initiated. And the TIMER ON indicator light illuminates. Press the up or down button to select the desired Auto start time.
- When the unit is off, press the Timer button to initiate the Auto start program, press it again within 10 seconds will initiate the Auto stop program.
- Press or hold the UP or DOWN button to change the Auto time by 0.5 hour increments, up to 10 hours, then at 1 hour increments up to 24 hours. The control will count down the time remaining until start.
- The system will automatically revert back to display the previous temperature setting if there is no operation in a 10 seconds period.
- Turning the unit ON or OFF at any time or adjusting the timer setting to 0.0 will cancel the Auto Start/Stop timer program.

DRY:

This mode is used to decrease the humidity in the room. Under this mode, you cannot select a fan speed. The fan motor operates at LOW speed. Keep windows and doors closed for the best dehumidifying effect.

COOL:

The temperature setting are adjustable between 17°C to 30°C. You can select your desired fan speed.

HEAT:

The temperature settings are adjustable between 17°C to 30°C in heating mode. You can select your desired fan speed.

AUTO:

The fan motor remains on MED speed in AUTO mode. The unit will select the appropriate operating mode from FAN, COOL or HEAT(For reverse cycle models only) based upon the temperature difference between the actual and desired room temperature. Some models without MED speed, the fan motor operates on HIGH speed in AUTO mode.

SLEEP:

Press and hold the "SWING" keypad for 2 seconds or use the remote control to activate the "SLEEP" feature. Press and hold the "SWING" keypad for 2 seconds or use the remote control again to deactivate the "SLEEP" feature. In the Cooling mode, the cooling temperature set point will increase 1°C per hour after the "SLEEP" mode is selected. Two hours later, the set point will continue at this temperature and the fan motor will remain on LOW speed. In the Heating mode, the heating temperature set point will decrease 1°C per hour after the "SLEEP" mode is selected. Two hours later, the set point will continue at this temperature and the fan motor will remain on LOW speed. This new temperature will be maintained for 7 hours, then the unit exits sleep mode and is off. Using the "SLEEP" mode will reduce noise creating a comfortable sleeping environment.

Turbo function(on some models)

Press the TURBO button by remote controller on COOL/HEAT (For models adopts Electrical heater only) mode, the air conditioner goes into powerful cooling/heating operation. Press again to cancel the TURBO function.

Get In Touch

 Call: 0845 6880112
 Email: info@adremit.co.uk

Our Address

Puravent, Adremit Limited, Unit 5a, Commercial Yard,
Settle, North Yorkshire, BD24 9RH

OPERATING INSTRUCTIONS(continued)

LED Display:

Shows the temperature setting or Auto-timer setting, after 10 seconds, shows the room temperature(on some models) or set temperature(on some models).

Shows Error codes:

- E0: Indoor EEPROM error;
- E1: Indoor & outdoor communication error;
- E3: Indoor fan motor speed out of control;
- E4: Room temperature sensor error;
- E5: Evaporator temperature sensor error;
- EC: Refrigerant leakage detection;
- F0: Current overload protection;
- F1: Outdoor temperature sensor error;
- F2: Condenser temperature sensor error;
- F3: Exhaust temperature sensor error;
- F4: Outdoor electric EE error;
- P0: IPM module error;
- P1: Voltage too high/too low protection;
- P2: Protection of IPM high temperature;
- P3: Protection of outdoor temperature too low (For the Cooling & Heating models);
- P4: Protection of compressor location;
- P7: Outdoor IGBT sensor error.

Note: When one of the above malfunctions occurs, turn off the unit, and check for any obstructions. Restart the unit, if the malfunction is still present, turn off the unit and unplug the power cord. Contact the manufacturer or its service agents or a similar qualified person for service.

Get In Touch



Call: [0845 6880112](tel:08456880112)



Email: info@adremit.co.uk

Our Address

Puravent, Adremit Limited, Unit 5a, Commercial Yard,
Settle, North Yorkshire, BD24 9RH

OPERATING INSTRUCTIONS(continued)

Vertical air flow adjustment (manually)

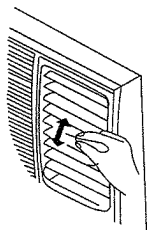

Air Filter

The air filter behind the inlet grille should be checked and cleaned at least once every 2 weeks (or as necessary) to maintain optimal performance of the air conditioner.

How to remove the air filter

Turn off the unit, disconnect /unplug from the power supply.

1. Hold the slot under the front panel, then uplift it outwards, and remove the front panel.
2. Pinch the handle under the air filter and make the air filter arched, remove it from the slot from underside to upside.
3. Clean the filter with warm, soapy water. The water should be below 40°C to prevent distortion of the filter.
4. Rinse off and gently shake off excess water from the filter. Allow the filter to dry before replacing it. To prevent distortion of the filter, do not dry in direct sunlight.

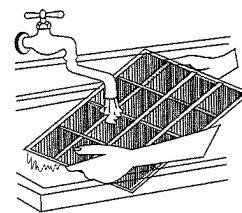
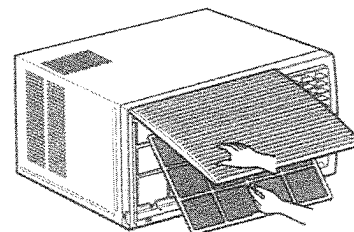

Cabinet Cleaning

- Be sure to unplug the air conditioner to prevent shock or fire hazard. The cabinet and front may be dusted with an oil-free cloth or washed with a cloth dampened in a solution of warm water and mild liquid dishwashing detergent. Rinse thoroughly and wipe dry.
- Never use harsh cleaners, wax or polish on the cabinet front.
- Be sure to wring excess water from the cloth before wiping around the controls.
- Excess water in or around the controls may cause damage to the air conditioner.
- Plug in air conditioner.

NOTE: Never use water over 50°C, alcohol, gasoline, acid, solvent or brush to clean the front panel as this will damage the surface of the part.

Winter Storage

If you plan to store the air conditioner during the winter, remove it carefully from the window according to the installation instructions. Cover it with plastic or return it to the original carton.



CAUTION



NEVER operate the air conditioner without the air filter, as dust/dirt particles can contribute to equipment failure.

OPERATING INSTRUCTIONS(continued)

Drainage

To treat condensed water will be as follows:

1. Bottom drainage. Connect drain hose to the bottom drain tray. It will slightly affect cooling performance, but will reduce the noise caused by spraying the condensed water.

Note: Only optional for models with bottom drain hole. For pump heating, the bottom drainage must be chosen.

2. Back drainage. Connect drain hose to the back drainage hole. It will slightly affect cooling performance, but will reduce the noise caused by spraying the condensed water.

3. Non-drainage. Block the drain hole(s) by rubber plug(s). The condensed water will be sprayed to condenser, and will improve the cooling performance.

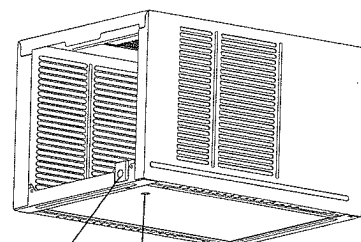

Installation procedures of bottom drainage:

- Remove the rubber plug from the bottom of cabinet(if installed).
- Take out the drain tray and screws from accessory.
- Fix the drain tray onto the bottom of cabinet by screws.
- Connect an extension drain hose (locally purchased) to the outlet of drain tray.

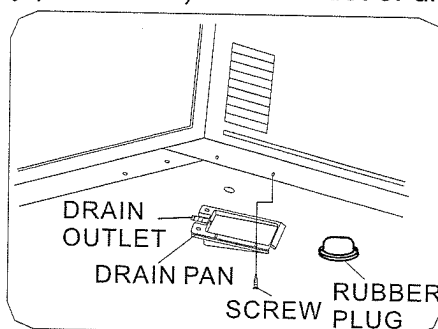
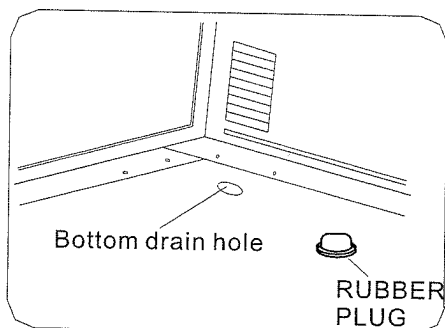

Installation procedures of back drainage:

- Fit the seal (provided as accessory) onto the drain joint.
 - Insert the drain joint to the back drainage hole, and rotate it by 90° to be well fitted.
 - Connect an extension drain hose (locally purchased) to the drain joint.
 - Make sure block the bottom drain hole by rubble plug.
- Note: Drain hose is locally purchased according to installation length request.

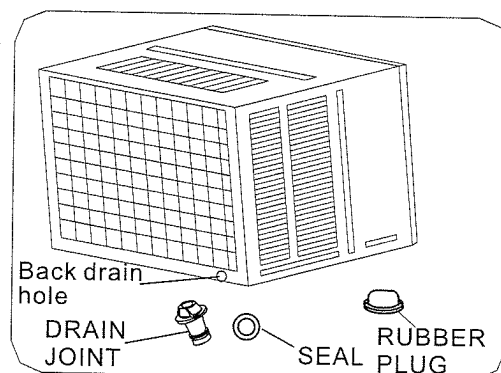

NOTE: If you choose non-drainage when cooling, both the bottom and the back drain holes of the unit should be inserted with rubber plugs. When you choose non-drainage the air conditioner will be perfect cooling efficiency, but big noise may be caused by spraying the condensed water. Does not recommend to use.

NOTE: The rated cooling performance is tested under non-drainage status.

NOTE: Make sure that water will not leak from the surrounding area when rubber plug and joint were used. Please seal it in case leakage is found.

INSTALLATION INSTRUCTIONS

NOTE: Before installing, remove all packaging from inside the carton, along with any inserts placed into the side louvers.

Select the best location

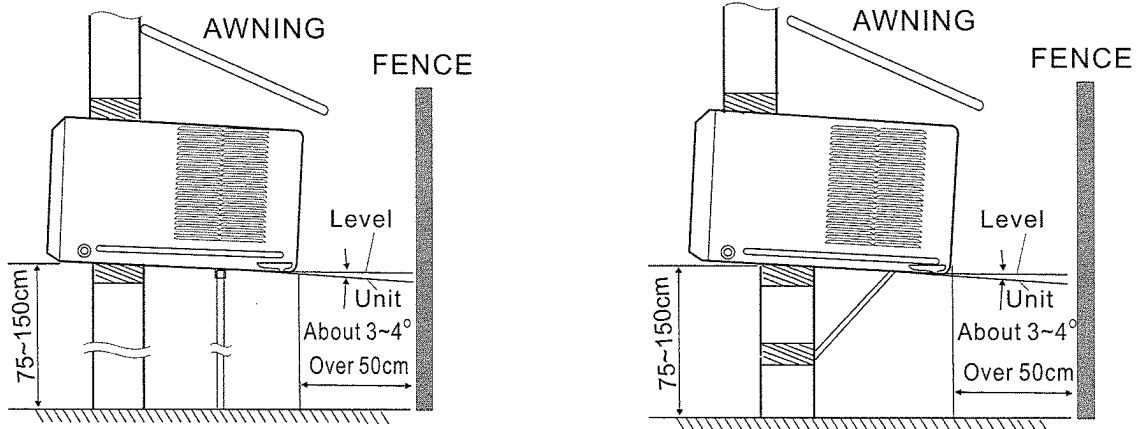

1. To avoid vibration and noise, make sure the unit is installed securely and firmly.
2. Install the unit where the sunlight does not shine directly on the unit.
If the unit receives direct sunlight, build an awning to shade the cabinet.
3. There should be no obstacle, such as a fence or wall, within 50cm from the back of the cabinet because it will prevent heat radiation of the condenser.
Restriction of outside air will greatly reduce the cooling and heating efficiency of the air conditioner.
4. Install the unit a little obliquely downward to outside not to leak the condensed water into the room (about 3~4° with level).
5. Install the unit with its bottom portion 75~150cm above the floor level.
6. The power cord must be connected to an independent circuit. The yellow/green wire must be grounded.

CAUTION

All side louvers of the cabinet must remain exposed to the outside of the structure.

Installation of the Housing

Step 1

Remove the air conditioner from its packaging, remove fixing screws and slide the air conditioner out of its housing (Refer to Installation Steps).

Step 2

Prepare the hole in the wall so that the bottom of the housing is well supported, the top has minimum clearance and the air inlet louvers have clearance as shown below in options A and B. Holes from the outside through to the cavity should be sealed. The housing should slope down towards the rear by about 5mm to allow water formed during operation to drain.

Step 3

Install the housing into the wall and secure. Ensure the foam seals are not damaged. Flash, seal or fill gaps around the inside and outside to provide satisfactory appearance and protection against the weather, insects and rodents.

NOTE: UNIT MAY BE SUPPORTED BY A SOLID FRAME FROM BELOW OR BY A HANGER FROM A SOLID OVERHEAD SUPPORT. FLASH OR SEAL AROUND EXTERNAL WALL FRAME OR ARCHITRAVE

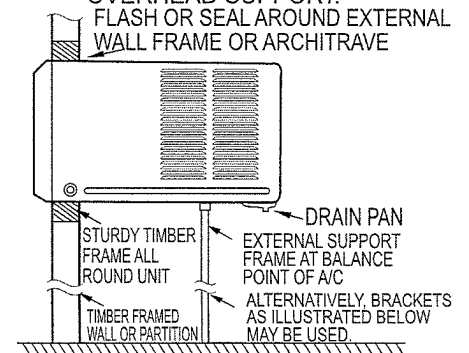

Preferred method of installation into a timber framed wall, partition or window.

Installation of the unit into the Housing

1. Slide the unit into the housing until it is firmly against the rear of the housing. Care is required to ensure the foam sealing strips on the housing remain in position.
2. Connect the air conditioner to the power and position excess cord length beneath the air conditioner base.
3. Engage the chassis fixing brackets into the bottom housing rail and secure to the base with the screw provided.
4. Remove the front panel from it's carton and plastic bag and fit as per the Installation Instruction.
5. Switch unit on. Check for operation of the unit and check for vibration in the installation.
6. Fit the drain pan to the housing and run a drain line to a suitable location if required.

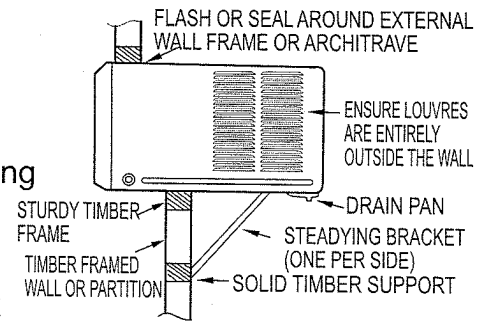

Alternative method of installation if external support cannot be provided.

Installations of the unit into the wall

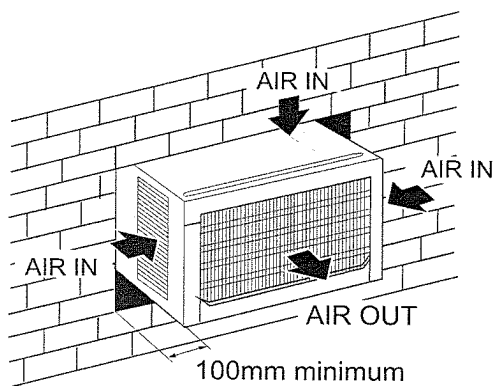

OPTION A

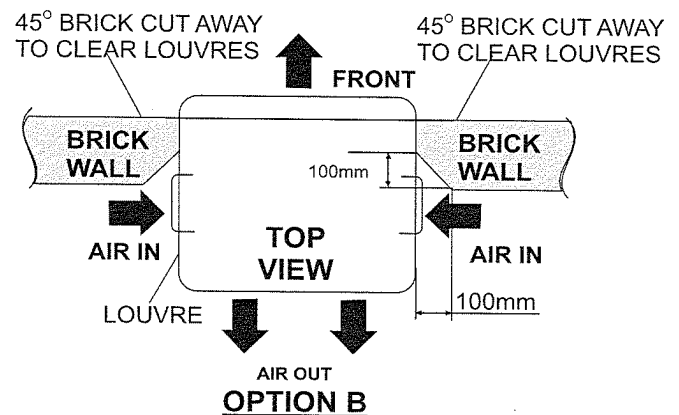

Installation Steps

Step 1. Remove the front panel and the air filter

1. Hold the slot under the front panel, then uplift it outwards, and remove the front panel (See Fig.1).
2. Pinch the handle under the air filter and make the air filter arched, remove it from the slot from underside to upside (See Fig.2).

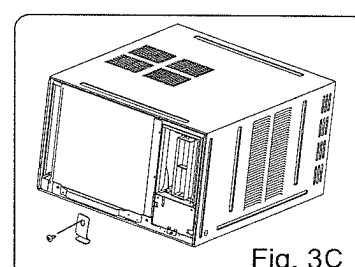
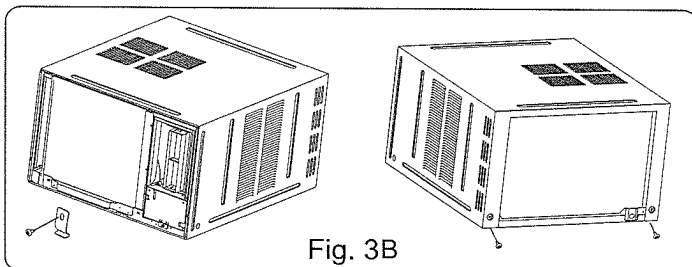
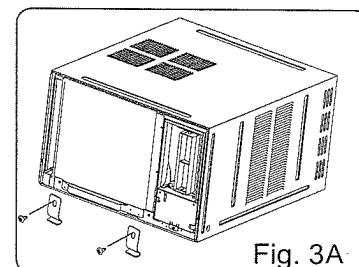
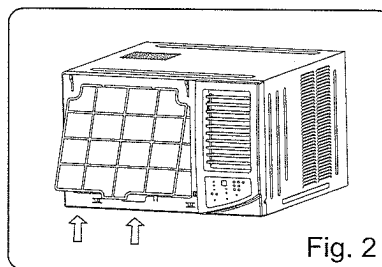
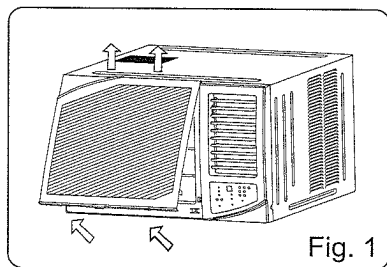

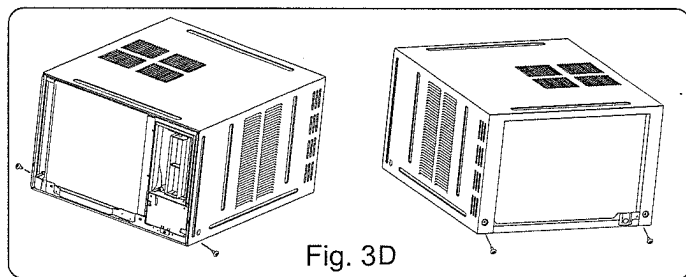

Fig. 3D

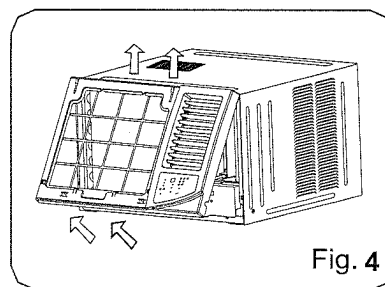

Fig. 4

Step 2. Remove the frame.

- To meet different requirement of different type of air conditioner, there are four kinds of removing the frame.
 - Remove the two screws on the left and right chassis fixing brackets, then remove the two chassis fixing brackets as shown in Fig.3A.
 - Remove one screw on the chassis fixing bracket, then remove the chassis fixing bracket. Remove the two screws located on the back of the cabinet as shown in Fig.3B.
 - Remove one screw on the chassis fixing bracket, then remove the chassis fixing bracket as shown in Fig.3C.
 - Remove the four screws located on both sides and the back of the cabinet as shown in Fig.3D.
- Grasp the left corner of the frame's underside, release the coupler plugs, then loosen the frame (See Fig.4).

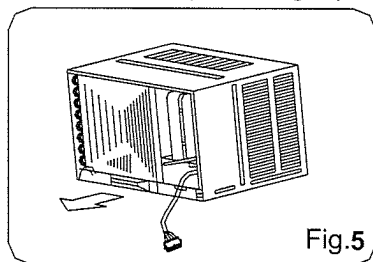

Fig.5

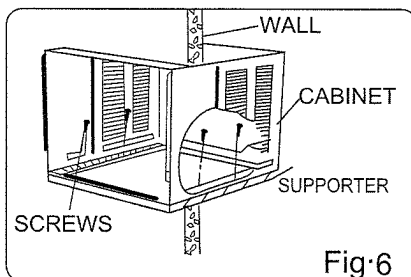

Fig.6

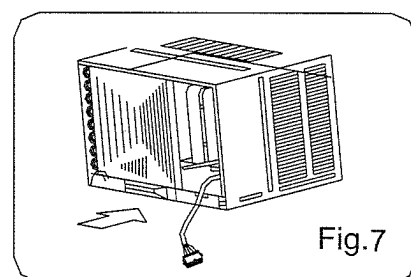

Fig.7

Step 3. Installation.

- Grasp the handle on the chassis and carefully slide the air conditioner out of the cabinet (See Fig.5).
- Remove shipping pad from around compressor before operation and make sure the discharge points to the drain pan are aligned before the chassis is pushed into the cabinet (See Fig.6).
- Push the unit chassis into the cabinet (See Fig.7).

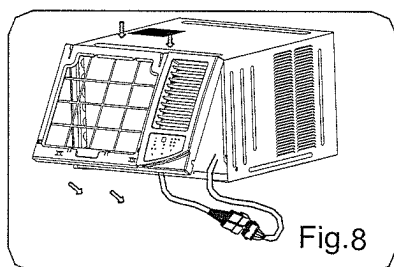

Fig.8

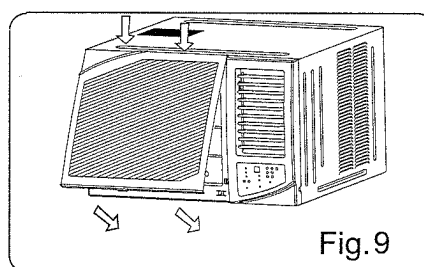

Fig.9

Step 4. Install the frame.

- Install the frame and connect the coupler plugs, making sure not to interfere with the temperature sensor cable (See Fig.8).
- Fix the screws on the frame (See Fig.3A,3B,3C,3D).

Step 5. Install the air filter and front panel.

- Install the air filter into the frame's slot from upside to underside (See Fig.2).
- Hang the front panel on the frame's buckle, then press the front panel into the frame's slot until you hear a click (See Fig9).

TROUBLESHOOTING

Troubleshooting Tips

Save time and money! Review the chart below first and you may not need to call for service.



Normal Operation

- You may hear a pinging noise caused by water being picked up and thrown against the condenser on rainy days or when the humidity is high. This design feature helps remove moisture and improve efficiency.
- You may hear the thermostat click when the compressor cycles on and off.
- Water will collect in the base pan during high humidity or on rainy days. The water may overflow and drip from the outdoor side of the unit.
- The fan may continue to operate when the compressor has cycled off.

Abnormal Operation

Problem	Possible Causes	What To Do
Air conditioner does not start	<ul style="list-style-type: none"> ■ <i>The air conditioner is unplugged.</i> ■ <i>The fuse is blown/circuit breaker is tripped.</i> ■ <i>Power failure.</i> 	<ul style="list-style-type: none"> • Make sure the air conditioner plug is pushed completely into the outlet and switched on. • Check the house fuse/circuit breaker box and replace the fuse or reset the breaker. • If power failure occurs, switch off and disconnect/unplug the power cord. When power is restored, reconnect (plug in) the power cord, switch on the power and wait 3 minutes to restart the air conditioner to prevent tripping of the compressor overload.
Air conditioner does not cool as it should	<ul style="list-style-type: none"> ■ <i>Airflow is restricted.</i> ■ <i>The air filter is dirty.</i> ■ <i>The room may have been hot.</i> ■ <i>Cold air is escaping.</i> ■ <i>Cooling coils have iced up.</i> 	<ul style="list-style-type: none"> • Make sure there are no curtains, blinds, or furniture blocking the front of the air conditioner. • Clean the filter at least every 2 weeks. See the operating instructions section. • When the air conditioner is first turned on you need to allow time for the room to cool down. • Check for open furnace floor registers and cold air returns. • Set the air conditioner's vent to the closed position. • See Air Conditioner Freezing Up below.
Air conditioner freezing up	<ul style="list-style-type: none"> ■ <i>Ice blocks the air flow and stops the air conditioner from cooling the room.</i> 	<ul style="list-style-type: none"> • Set the fan at MED or HIGH until the ice melts.

Get In Touch

 Call: 0845 6880112
 Email: info@adremit.co.uk

Our Address

Puravent, Adremit Limited, Unit 5a, Commercial Yard, Settle, North Yorkshire, BD24 9RH

SPECIFICATIONS

Unit dimensions:

MODEL (Btu/h)	BODY DIMENSION(mm) (W X H X D)
5000~6000	445X320X415
	450X346X535
7000~9000	450X346X535
	450X346X585
9000~12000	560X400X640
	600X380X560
15000~16000	660X434X620
15000~24000	660X428X680
	660X428X780

NOTE: Value of D is for reference only.

Minimum nominal cross-sectional area of conductors:

Rated current of appliance(A)	Nominal cross-sectional area(mm ²)
>3 and ≤ 6	0.75
>6 and ≤ 10	1
>10 and ≤ 16	1.5
>16 and ≤ 25	2.5

Suggest Minimum Wire Size(AWG:American Wire Gage):

Appliance Amps	AWG Wire Size
10	18
13	16
18	14
25	12
30	10

Get In Touch



 Call: 0845 6880112
 Email: info@adremit.co.uk

Our Address

Puravent, Adremit Limited, Unit 5a, Commercial Yard,
Settle, North Yorkshire, BD24 9RH



Get In Touch



 **Call:** [0845 6880112](tel:08456880112)
 **Email:** info@adremit.co.uk

Our Address

Puravent, Adremit Limited, Unit 5a, Commercial Yard,
Settle, North Yorkshire, BD24 9RH



Get In Touch

 **Call:** [0845 6880112](tel:08456880112)
 **Email:** info@adremit.co.uk

Our Address

Puravent, Adremit Limited, Unit 5a, Commercial Yard,
Settle, North Yorkshire, BD24 9RH



MWE2-09CRDN8-QRE1
MWE2-12CRDN8-QRE1
MWE2-09CRDN8-NC6
MWE2-12CRDN8-NC5

The design and specifications are subject to change without prior notice for product improvement. Consult with the sales agency or manufacturer for details. Any updates to the manual will be uploaded to the service website, please check for the latest version.

**CS382-U2B(HK)(J)BPG
16120300000387**

GD MIDEAAIR-CONDITIONING EQUIPMENT CO.,LTD.
Lingang Road Beijiao Shunde Foshan Guangdong People s Republic of China 528311

Get In Touch



Call: [0845 6880112](tel:08456880112)



Email: info@adremit.co.uk

Our Address

Puravent, Adremit Limited, Unit 5a, Commercial Yard,
Settle, North Yorkshire, BD24 9RH