



**AW C, AW CE, AW D, AW Ex and AW H**  
**Hot water fan heaters for**  
**demanding environments**

**Get In Touch**

 **Call:** [0845 6880112](tel:08456880112)  
 **Email:** [info@adremit.co.uk](mailto:info@adremit.co.uk)

**Our Address**

Puravent, Adremit Limited, Unit 5a, Commercial Yard,  
Settle, North Yorkshire, BD24 9RH



# AW C, AW CE, AW D, AW Ex and AW H

## Fan heaters for demanding environments

The AW fans for demanding environments is a range of fan heaters suitable for environments with strict demands on materials and safety, such as offshore, corrosive environments, or chemical industry. All fans are easy to install. The AW fans are available in two sizes and five different models.

- Two sizes and five models
- Stainless steel casing
- Intended for wall mounting
- Simple 230 VAC installation (AW Ex 400 VAC 3ph)
- Adjustable air deflector grille deflects the air up and down
- AW CE/Ex/H features an inspection cover for cleaning the fan and water coil
- AW C/D features an openable front panel for easy cleaning
- All models are intended to be controlled externally



### Design

Each model has a unique design to make it suitable for a specific environment.

AW C for corrosive environments: refer to page 4

AW CE for corrosive environments: refer to page 6

AW D for dusty environments: refer to page 8

AW Ex for Ex designated environments: refer to page 10

AW H for working conditions up to 70 °C: refer to page 14

### Capacity

Capacity tables are shown next to each model.

AW C / CE / D / Ex / H

### Approvals

The fan heaters are manufactured in accordance with:

LVD directive: EN 60355-1 and EN 60335-2-30

EMC directive: EN 61000-6-1, EN 61000-6-2, EN 61000-6-3, and EN 61000-6-4

EMF directive: EN 62233

For approvals of AW Ex, refer to page 8.



#### Get In Touch

Call: 0845 6880112

Email: [info@adremit.co.uk](mailto:info@adremit.co.uk)

#### Our Address

Puravent, Adremit Limited, Unit 5a, Commercial Yard, Settle, North Yorkshire, BD24 9RH



*AW CE, AW Ex and AW H feature a quick release inspection cover, simplifying inspection and cleaning.*



*AW C and AW D features an openable front panel.*



*The openable front panels of AW C and AW D makes it easy to inspect and clean the fan and water coil.*

AW C / CE / D / Ex / H

Get In Touch

Call: [0845 6880112](tel:08456880112)  
Email: [info@adremit.co.uk](mailto:info@adremit.co.uk)

Our Address

Puravent, Adremit Limited, Unit 5a, Commercial Yard,  
Settle, North Yorkshire, BD24 9RH





# AW C

## Fan heaters for corrosive environments

AW C has been developed specifically for wall mounting in corrosive environments, such as offshore or chemical industry. AW C is IP65 protected against dust and water jets.

- Uses hot water as the energy medium
- Intended for use in humid and corrosive environments
- Meets the requirements for corrosion class C5-M
- Stainless acid-proof steel casing and bracket, EN 1.4404
- Water coil with stainless acid-proof steel tubes, EN 1.4404
- Nano-coated aluminium fins (fulfills corrosion class C5-M)
- Protection class IP65 – protected against dust and water jets

### Design

Casing and air deflector grilles are manufactured from stainless acid-proof steel, EN 1.4404. The coil features stainless acid-proof steel tubes and nano-coated aluminium fins.

Openable front panel for easy cleaning.

Protection class IP65 (protected against dust and water jets).

Supplied with wall-brackets.



### Controls

AW C is supplied without any automation and a single fan speed.

### Dimensional drawing

Refer to page 16.

### Accessories (Ordered separately)

	Product	Description
	Valve VM 8622-3,6 for AW C22	Stainless steel, EN 1.4401 230V, Degree of protection IP65 Max 140°C, 16 bar VM 8622 Kv 3,6, ¾" connection VM 8622 Kv 8,4, 1" connection
	Valve VM 8622-8,4 for AW C42	
	Thermostat AWST35	Sealed thermostat 0-35 °C. Degree of protection IP65 2,6 A AC3
	Filter AWPFC	Max. hot water temperature with installed filter is 100 °C.

#### Get In Touch

Call: 0845 6880112  
Email: [info@adremit.co.uk](mailto:info@adremit.co.uk)

#### Our Address

Puravent, Adremit Limited, Unit 5a, Commercial Yard,  
Settle, North Yorkshire, BD24 9RH



## Product range overview

Type		AW C22	AW C42
Power supply		230 VAC	230 VAC
Current consumption, max.	A	0.5	1.35
Air volume	m <sup>3</sup> /h	2160	4300
Sound pressure level	dB(A)	59	69
Throw length <sup>1)</sup>	m	7	10
Connecting pipes	inch	R3/4"	R3/4"
Max. working temp. water	°C	150	150
Max. working pressure (of water)	bar	16	16
Max. ambient temperature	°C	70 <sup>2)</sup>	70 <sup>2)</sup>
Weight	kg	31	47
Protection class		IP65	IP65

<sup>1)</sup> Measured 5 metres in front of the AW.

<sup>2)</sup> 35 °C using the VEAB thermostat.

## Capacity AW C22

Water temp.		in/out 90 °C/70 °C				in/out 80 °C/60 °C				in/out 60 °C/40 °C			
Air flow	Supply air	Output air	Power	Flow water	Pressure drop water	Output air	Power	Flow water	Pressure drop water	Output air	Power	Flow water	Pressure drop water
m <sup>3</sup> /h	°C	°C	kW	l/s	kPa	°C	kW	l/s	kPa	°C	kW	l/s	kPa
2160	+5	44.5	28.9	0.36	16.5	38.2	24.3	0.30	12.2	25.4	14.9	0.18	4.9
2160	+15	48.4	24.6	0.30	12.2	42.1	20.0	0.24	8.2	29.5	10.7	0.13	2.7

## Capacity AW C42

Water temp.		in/out 90 °C/70 °C				in/out 80 °C/60 °C				in/out 60 °C/40 °C			
Air flow	Supply air	Output air	Power	Flow water	Pressure drop water	Output air	Power	Flow water	Pressure drop water	Output air	Power	Flow water	Pressure drop water
m <sup>3</sup> /h	°C	°C	kW	l/s	kPa	°C	kW	l/s	kPa	°C	kW	l/s	kPa
4300	+5	42.2	54.1	0.66	19.2	36.1	45.2	0.55	13.7	23.8	27.4	0.33	5.5
4300	+15	46.3	46.0	0.56	14.0	40.3	37.2	0.45	9.4	28.2	19.4	0.24	2.7

You can also do your own calculations using our web-based VEAB Select calculation program ([www.veab.com](http://www.veab.com)), or get in touch with our sales technicians for assistance.

### Project design/orders

#### Descriptive text - AW C

Hot water fan heater, VEAB type AW C, with stainless acid-proof steel casing and air deflector grilles, EN 1.4404. Coil with stainless acid-proof steel, EN 1.4404, tubes and nano-coated aluminium fins. Meets the requirements for corrosion class C5-M. Openable front panel for easy cleaning. Protection class IP65. Supplied with wall-brackets. Accessories such as valve, thermostat and filter are ordered separately.

#### Get In Touch

Call: 0845 6880112  
Email: [info@adremit.co.uk](mailto:info@adremit.co.uk)

#### Our Address

Puravent, Adremit Limited, Unit 5a, Commercial Yard, Settle, North Yorkshire, BD24 9RH

# AW CE

## Fan heaters for corrosive environments

AW CE has been developed specifically for wall mounting in corrosive environments, such as offshore or chemical industry. AW CE is IP65 protected against dust and water jets.

- Uses hot water as the energy medium
- Intended for use in humid and corrosive environments
- Meets the requirements for corrosion class C5-I and C5-M
- Stainless acid-proof steel casing and air deflector grilles, EN 1.4404
- Water coil with copper tubes and ElectronFin E-coated aluminium fins.
- Quick release inspection cover
- Protection class IP65

### Design

Casing and air deflector grilles are manufactured from stainless acid-proof steel, EN 1.4404. Water coil that meets the requirements for corrosion class C5-I and C5-M. Coil med kopparrör och aluminiumlameller som ytbehandlats med ElectroFin E-coat. Detta innebär bl.a att hela coilet är doppmålat med flexibel epoxy polymer med 100% täckningsgrad. Termisk förlust mindre än 1% Quick release inspection cover for simpler cleaning. Protection class IP65 – protected against dust and water jets. Supplied with wall-brackets.





### Controls

AW CE is supplied without any automation and a single fan speed.



### Dimensional drawing

See page 16.

### Accessories (Ordered separately)

	Product	Description
	Valve VM 8622-3,6 for AW C22E	Stainless steel, EN 1.4401 230V, Degree of protection IP65 Max 140°C, 16 bar VM 8622 Kv 3,6, ¾" connection VM 8622 Kv 8,4, 1" connection
	Valve VM 8622-8,4 for AW C42E	
	Thermostat AWST35	Sealed thermostat 0-35 °C. Degree of protection IP65 2,6 A AC3
	Filter AWPFC	Max. hot water temperature with installed filter is 100 °C.

#### Get In Touch

 Call: 0845 6880112  
 Email: [info@adremit.co.uk](mailto:info@adremit.co.uk)

#### Our Address

Puravent, Adremit Limited, Unit 5a, Commercial Yard, Settle, North Yorkshire, BD24 9RH



## Product range overview

Type		AW C22E	AW C42E
Power supply		230V~	230V~
Current consumption, max.	A	0,5	1,35
Air volume	m <sup>3</sup> /h	2100	4200
Sound pressure level	dB(A)	59	69
Throw length <sup>1)</sup>	m	7	10
Connecting pipes		R3/4"	R1"
Max. working temp. water	°C	150	150
Max. working pressure (of water)	bar	16	16
Max. ambient temperature	°C	70 <sup>2)</sup>	70 <sup>2)</sup>
Weight	kg	29	45
Degree of protection		IP65	IP65

<sup>1)</sup> Measured 5 metres in front of the AW.

<sup>2)</sup> 35 °C using the VEAB thermostat.

## Capacity AW C22E

Water temp.		in/out 90 °C/70 °C				in/out 80 °C/60 °C				in/out 60 °C/40 °C			
Air flow	Supply air	Output air	Power	Flow water	Pressure drop water	Output air	Power	Flow water	Pressure drop water	Output air	Power	Flow water	Pressure drop water
m <sup>3</sup> /h	°C	°C	kW	l/s	kPa	°C	kW	l/s	kPa	°C	kW	l/s	kPa
2100	+5	45,2	29,5	0,37	11,9	39,4	25,2	0,31	9,0	27,4	16,4	0,20	4,2
2100	+15	50,1	24,8	0,31	8,6	44,2	20,6	0,26	6,1	31,9	11,9	0,15	2,3

## Capacity AW C42E

Water temp.		in/out 90 °C/70 °C				in/out 80 °C/60 °C				in/out 60 °C/40 °C			
Air flow	Supply air	Output air	Power	Flow water	Pressure drop water	Output air	Power	Flow water	Pressure drop water	Output air	Power	Flow water	Pressure drop water
m <sup>3</sup> /h	°C	°C	kW	l/s	kPa	°C	kW	l/s	kPa	°C	kW	l/s	kPa
4200	+5	43,6	56,6	0,70	30,3	38,1	48,5	0,60	23,1	26,9	32,2	0,40	11,2
4200	+15	48,8	47,7	0,59	22	43,2	39,8	0,49	15,9	31,8	23,7	0,29	6,4

You can also do your own calculations using our web-based VEAB Select calculation program ([www.veab.com](http://www.veab.com)), or get in touch with our sales technicians for assistance.

### Project design/orders

#### Descriptive text - AW CE

Fan heater for hot water, VEAB type AW CE, with stainless acid-proof steel casing and air deflector grilles, EN 1.4404. Water coil with copper tubes and ElectronFin E-coated aluminium fins. Meets the requirements for corrosion class C5-M and C5-I. Quick release inspection cover for simpler cleaning. Protection class IP65. Supplied with wall-brackets. Accessories such as valve, thermostat and filter are ordered separately.

#### Get In Touch

Call: 0845 6880112  
Email: [info@adremit.co.uk](mailto:info@adremit.co.uk)

#### Our Address

Puravent, Adremit Limited, Unit 5a, Commercial Yard, Settle, North Yorkshire, BD24 9RH



# AW D

## Fan heaters for dusty environments

AW D has been developed specifically for heating the air in dusty environments, such as industrial premises and woodworking premises.

- Uses hot water as the energy medium
- Intended for use in dusty environments
- Stainless acid-proof steel casing, EN 1.4404
- Water coil with copper tubes
- Fin spacing 4.2 mm
- Protection class IP65 – protected against dust and water jets

### Design

Casing is manufactured from stainless acid-proof steel, EN 1.4404.

The coil features copper tubes and aluminium fins.

The fin spacing is 4.2 mm to minimise the risk of dust and particles clogging up the water coil.

Openable front panel for easy cleaning.

Protection class IP65 (protected against dust and water jets).

Supplied with wall-brackets.





### Controls

AW D is supplied without any automation and a single fan speed.



### Dimensional drawing

Refer to page 17.

### Accessories (Ordered separately)

	Product	Description
	Valve VM 8631-8,4	230V, Degree of protection IP65 Max 140°C, 16 bar Kv 8,4 ¾" connection
	AWST35	Sealed thermostat 0-35 °C. Protection class IP65 2,6 A AC3
	Filter AWPFC	Max. hot water temperature with installed filter is 100 °C.

#### Get In Touch

 Call: 0845 6880112  
 Email: [info@adremit.co.uk](mailto:info@adremit.co.uk)

#### Our Address

Puravent, Adremit Limited, Unit 5a, Commercial Yard,  
Settle, North Yorkshire, BD24 9RH





## Product range overview

Type		AW D22	AW D42
Power supply		230 VAC	230 VAC
Current consumption, max.	A	0.5	1.35
Air volume	m <sup>3</sup> /h	2200	4430
Sound pressure level <sup>1)</sup>	dB(A)	59	69
Throw length	m	7	10
Connecting pipe	inch	R3/4"	R3/4"
Max. working temp. water	°C	150	150
Max. working pressure (of water)	bar	16	16
Max. ambient temperature	°C	70 <sup>2)</sup>	70 <sup>2)</sup>
Weight	kg	30	46
Protection class		IP65	IP65

<sup>1)</sup> Measured 5 metres in front of the AW.

<sup>2)</sup> 35 °C using the VEAB thermostat.

## Capacity AW D22

Water temp.		in/out 90 °C/70 °C				in/out 80 °C/60 °C				in/out 60 °C/40 °C			
Air flow	Supply air	Output air	Power	Flow water	Pressure drop water	Output air	Power	Flow water	Pressure drop water	Output air	Power	Flow water	Pressure drop water
m <sup>3</sup> /h	°C	°C	kW	l/s	kPa	°C	kW	l/s	kPa	°C	kW	l/s	kPa
2200	+5	32.8	21.8	0.27	4.7	28.8	18.7	0.23	6.5	20.8	12.4	0.15	3.2
2200	+15	39.4	18.4	0.23	6.3	35.4	15.3	0.19	4.6	27.1	9.1	0.11	1.8

## Capacity AW D42

Water temp.		in/out 90 °C/70 °C				in/out 80 °C/60 °C				in/out 60 °C/40 °C			
Air flow	Supply air	Output air	Power	Flow water	Pressure drop water	Output air	Power	Flow water	Pressure drop water	Output air	Power	Flow water	Pressure drop water
m <sup>3</sup> /h	°C	°C	kW	l/s	kPa	°C	kW	l/s	kPa	°C	kW	l/s	kPa
4430	+5	31.0	40.7	0.50	14.7	27.4	35.0	0.43	11.3	19.9	23.3	0.28	5.6
4430	+15	37.9	34.4	0.42	10.8	34.1	28.8	0.35	7.9	26.5	17.3	0.21	3.3

You can also do your own calculations using our web-based VEAB Select calculation program ([www.veab.com](http://www.veab.com)), or get in touch with our sales technicians for assistance.

### Project design/orders

#### Descriptive text - AW D

Hot water fan heater, VEAB type AW D, with stainless acid-proof steel casing, EN 1.4404. Water coil featuring copper tubes and aluminium fins. Openable front panel for easy cleaning. Protection class IP65. Supplied with wall-brackets. Accessories such as valve, thermostat and filter are ordered separately.

#### Get In Touch

Call: 0845 6880112  
Email: [info@adremit.co.uk](mailto:info@adremit.co.uk)

#### Our Address

Puravent, Adremit Limited, Unit 5a, Commercial Yard, Settle, North Yorkshire, BD24 9RH



# AW Ex

## Hot water fan heaters for hazardous areas

AW Ex has been developed specifically for heating the air in environments with occasional danger of explosion (Zone 1 and Zone 2).

- Uses hot water as the energy medium
- Approved for use in areas where the danger of explosion is due to gases or fumes (equipment category 2G)
- Stainless sheet metal casing, EN 1.4016
- Water coil with copper tubes
- Temperature class T4 (max. 135 °C)
- Max. ambient temperature 40 °C
- Protection class IP44 – splash proof
- Thermistor motor protection U-EK230E is included.

### Design

Stainless sheet metal casing, EN 1.4016. The coil features copper tubes and aluminium fins.

Quick release inspection cover for inspection and simpler cleaning. Protection class IP44 (splash proof).

Supplied with wall bracket and thermistor motor protection.

### Controls

AW Ex is supplied with an Ex classed fan motor junction box. To fulfill the approval of AW Ex the supplemented thermistor motor protection must be installed.

### Thermistor motor protection

The U-EK 230E is a thermistor motor protection device which is intended for use in conjunction with a contactor for the protection of Ex fans. The fan motors have six series-connected thermistors, two per phase winding, whose resistance is determined by the motor temperature. When the motor temperature exceeds the permitted limit, the resistance rises sharply and the motor protection is triggered. U-EK230E must be placed outside the Ex zone. Designed for snap fitting on to a 35 mm instrument rail.

### Dimensional drawing

Refer to page 18.



U-EK230E

#### Get In Touch



Call: [0845 6880112](tel:08456880112)



Email: [info@adremit.co.uk](mailto:info@adremit.co.uk)

#### Our Address

Puravent, Adremit Limited, Unit 5a, Commercial Yard, Settle, North Yorkshire, BD24 9RH



## Product range overview

Type		AW Ex22	AW Ex42
Power supply		400V3~	400V3~
Current consumption, max.	A	0.27	0.51
Air volume	m <sup>3</sup> /h	2250	4150
Sound pressure level	dB(A)	61	67
Throw length <sup>1)</sup>	m	8	10
Connecting pipe	mm	Ø22	Ø28
Max. working temp. water	°C	125	125
Max. working pressure (of water)	bar	16	16
Ambient temperature	°C	-20 °C - +40 °C	-20 °C - +40 °C
Weight	kg	25	42
Protection class, motor		IP44	IP44

<sup>1)</sup> Measured 5 metres in front of the AW.

## Markings



**II 2 G c Ex e IIB T4 Gb**

### Approvals

AW Ex is manufactured in accordance with:

LVD directive: EN 60355-1 and EN 60335-2-30

EMC directive: EN 61000-6-1, EN 61000-6-2, EN 61000-6-3, and EN 61000-6-4

EMF directive: EN 62233

AW Ex meets the requirements of ATEX directive 94/9/EC in EC/EFTA.

VEAB quality system is certified by Intertek (NB 0359) according to certificate ITS09ATEXQ6440

Tests and certifications of AW Ex have been performed by NEMKO.

Applied testing standards:

Protection class IP44, IEC/EN 60529

General ATEX requirements IEC/EN 60079-0

EX e (increased safety) IEC/EN 60079-7



### Get In Touch

Call: 0845 6880112  
 Email: [info@adremit.co.uk](mailto:info@adremit.co.uk)

### Our Address

Puravent, Adremit Limited, Unit 5a, Commercial Yard,  
Settle, North Yorkshire, BD24 9RH



## Capacity AW Ex22

Water temp.		in/out 90 °C/70 °C				in/out 80 °C/60 °C				in/out 60 °C/40 °C			
Air flow	Supply air	Output air	Power	Flow water	Pressure drop water	Output air	Power	Flow water	Pressure drop water	Output air	Power	Flow water	Pressure drop water
m <sup>3</sup> /h	°C	°C	kW	l/s	kPa	°C	kW	l/s	kPa	°C	kW	l/s	kPa
2250	+5	43,4	30,5	0,38	12,0	37,8	26,0	0,37	9,0	26,3	16,9	0,21	4,2
2250	+15	48,6	25,6	0,37	8,6	42,8	21,2	0,20	6,2	31,1	12,3	0,15	2,3

## Capacity AW Ex42

Water temp.		in/out 90 °C/70 °C				in/out 80 °C/60 °C				in/out 60 °C/40 °C			
Air flow	Supply air	Output air	Power	Flow water	Pressure drop water	Output air	Power	Flow water	Pressure drop water	Output air	Power	Flow water	Pressure drop water
m <sup>3</sup> /h	°C	°C	kW	l/s	kPa	°C	kW	l/s	kPa	°C	kW	l/s	kPa
4150	+5	42,5	54,9	0,68	18,7	37,1	47,0	0,58	14,2	26,1	30,9	0,38	6,8
4150	+15	47,8	46,2	0,57	13,6	42,3	38,5	0,47	9,8	31,0	22,6	0,27	3,8

You can also do your own calculations using our web-based VEAB Select calculation program ([www.veab.com](http://www.veab.com)), or get in touch with our sales technicians for assistance.



### Get In Touch

 Call: [0845 6880112](tel:08456880112)  
 Email: [info@adremit.co.uk](mailto:info@adremit.co.uk)

### Our Address

Puravent, Adremit Limited, Unit 5a, Commercial Yard,  
Settle, North Yorkshire, BD24 9RH

**Accessories** (Ordered separately)



	Product	Description
	U-EK	U-EK, plastic housing for U-EK230E. Degree of protection IP54 Dimension: WxHxD (mm.): 74 x 135 x 100
	Thermostat TRK	Thermostat with internal temperature setting. Temperature range: 0-50°C, max temperature with AW-EX is +40°C Data : 16,0 A, 400V. Degree of protection IP65. Temperature class T6. Marking EX II 2 G Ex de mb II C T6.
	Transformer RTRD 2	With RTRD 2 the fan motor speed for AW Ex can be adjusted in 5 steps. Data: 2,0 A, 3 x 400V, 50 Hz. Degree of protection IP54. Dimension: WxHxD (mm.): 240x284x132mm RTRD 2 must be placed outside the EX zone.

**Project design/orders****Descriptive text - AW Ex**

Hot water fan heater, VEAB type AW Ex, with stainless sheet metal casing, EN 1.4016. Water coil with copper tubes and aluminium fins. Quick release inspection cover for inspection and simpler cleaning. Supplied with wall bracket and thermistor motor protection. Degree of protection IP44. Accessories are ordered separately.

Marking: Ex II 2 G c Ex e IIB T4 Gb  
Casing material: Stainless EN 1.4016  
Degree of protection: IP44  
Temperature class: T4 (max. 135 °C)  
Max. ambient temperature: -20 °C - +40 °C

**Get In Touch**

 **Call:** 0845 6880112  
 **Email:** [info@adremit.co.uk](mailto:info@adremit.co.uk)

**Our Address**

Puravent, Adremit Limited, Unit 5a, Commercial Yard,  
Settle, North Yorkshire, BD24 9RH



# AW H

## Fan heaters for working conditions up to 70 °C

AW H has been developed specifically for heating the air in high ambient temperature environments, e.g. in the drying and curing industry and in decontamination work.

- Uses hot water as the energy medium
- Intended for high ambient temperature environments
- Stainless sheet metal casing, EN 1.4016
- Water coil with copper tubes
- Fins with a hydrophilic coating for, among other things, easier cleaning and durability.
- Protection class IP65 – protected against dust and water jets

### Design

Stainless sheet metal casing, EN 1.4016. The water coil features copper tubes and aluminium fins with a hydrophilic coating. Protection class IP65 (protected against dust and water jets).

Supplied with wall bracket.

### Controls



AW H is supplied without any automation and a single fan speed.

### Dimensional drawing



Refer to page 19.

### Accessories (Ordered separately)



	Product	Description
	Valve VM 8631-8,4	230V, Degree of protection IP65 Max 140°C, 16 bar Kv 8,4 ¾" connection
	AWST35	Sealed thermostat 0-35 °C. Protection class IP65 2,6 A AC3
	Filter AWPFC	Max. hot water temperature with installed filter is 100 °C.

#### Get In Touch

 Call: 0845 6880112  
 Email: [info@adremit.co.uk](mailto:info@adremit.co.uk)

#### Our Address

Puravent, Adremit Limited, Unit 5a, Commercial Yard, Settle, North Yorkshire, BD24 9RH

## Product range overview

Type		AW H22	AW H42
Power supply		230 VAC	230 VAC
Current consumption, max.	A	0.5	1.35
Air volume	m <sup>3</sup> /h	1830	3870
Sound pressure level	dB(A)	57	68
Throw length <sup>1)</sup>	m	6	9
Connecting pipe	mm	Ø22	Ø28
Max. working temp. water	°C	150	150
Max. working pressure (of water)	bar	16	16
Max. ambient temperature	°C	70	70
Weight	kg	28	46
Protection class		IP65	IP65

<sup>1)</sup> Measured 5 metres in front of the AW.

## Capacity AW H22

Water temp.		in/out 90 °C/70 °C				in/out 80 °C/60 °C				in/out 98 °C/85 °C			
Air flow	Supply air	Output air	Power	Flow water	Pressure drop water	Output air	Power	Flow water	Pressure drop water	Output air	Power	Flow water	Pressure drop water
m <sup>3</sup> /h	°C	°C	kW	l/s	kPa	°C	kW	l/s	kPa	°C	kW	l/s	kPa
1830	20	63.6	26.6	0.33	8.3	55.9	21.8	0.27	5.9	72.7	32.1	0.61	26.5
1830	40	69.4	16.3	0.20	3.4	61.2	11.8	0.14	1.9	78.9	21.6	0.41	12.6
1830	60	73.5	6.6	0.09	0.6	67.3	3.6	0.06	0.14	84.4	11.9	0.33	4.2

\* At 60 °C inlet air temp., the water temp. is 80 °C/65 °C.

## Capacity AW H42

Water temp.		in/out 90 °C/70 °C				in/out 80 °C/60 °C				in/out 98 °C/85 °C			
Air flow	Supply air	Output air	Power	Flow water	Pressure drop water	Output air	Power	Flow water	Pressure drop water	Output air	Power	Flow water	Pressure drop water
m <sup>3</sup> /h	°C	°C	kW	l/s	kPa	°C	kW	l/s	kPa	°C	kW	l/s	kPa
3870	20	60.7	52.4	0.65	10.6	53.4	43.0	0.53	7.5	69.4	63.6	1.21	34
3870	40	67.3	32.1	0.40	4.3	59.6	23.1	0.28	2.4	76.4	42.8	0.82	16.2
3870	60	72.5	12.9	0.16	0.8	66.0	7.1	0.12	0.5	82.8	23.6	0.45	5.3

\* At 60 °C inlet air temp., the water temp. is 80 °C/65 °C.

You can also do your own calculations using our web-based VEAB Select calculation program ([www.veab.com](http://www.veab.com)), or get in touch with our sales technicians for assistance.

## Project design/orders

### Descriptive text - AW H

Hot water fan heater, VEAB type AW H, with stainless sheet metal casing, EN 1.4016. The water coil features copper tubes and aluminium fins with a hydrophilic coating. Quick release inspection cover for inspection and simpler cleaning. Supplied with wall bracket. Accessories such as valve, thermostat and filter are ordered separately.



## Dimensional drawing

### AW C

Dimensions	A mm	B mm	C mm	D mm	E	F mm	G mm	H mm	Ø I
AW C22	585	535	395	705	G 3/4"	250	330	410	10
AW C42	740	660	395	725	G 3/4"	270	420	505	10

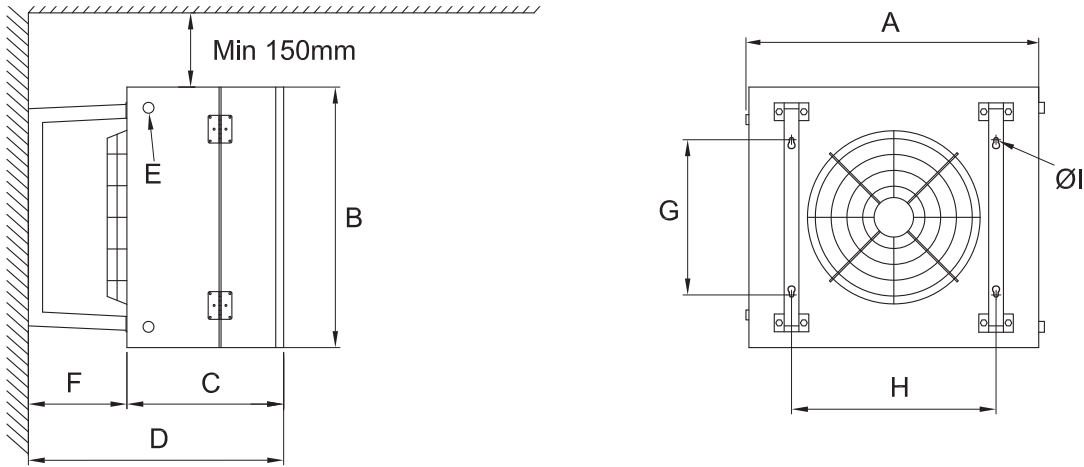

### AW CE

Dimensions	A mm	B mm	C mm	D mm	E	F mm	G mm	H mm	Ø I
AW C22E	550	530	380	630	R 3/4"	250	330	410	10
AW C42E	705	655	430	700	R 1"	270	420	505	10

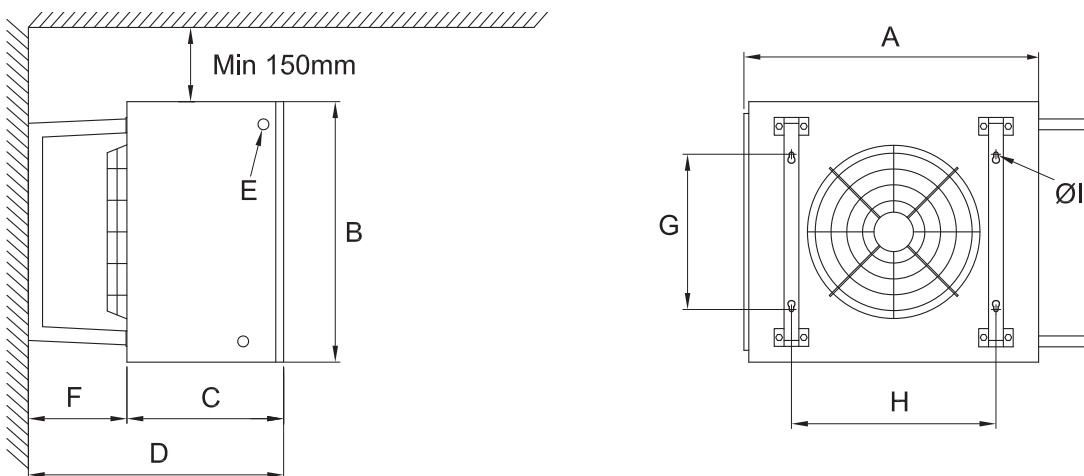

AW C / CE / D / Ex / H

#### Get In Touch

Call: [0845 6880112](tel:08456880112)  
 Email: [info@adremit.co.uk](mailto:info@adremit.co.uk)

#### Our Address

Puravent, Adremit Limited, Unit 5a, Commercial Yard,  
 Settle, North Yorkshire, BD24 9RH





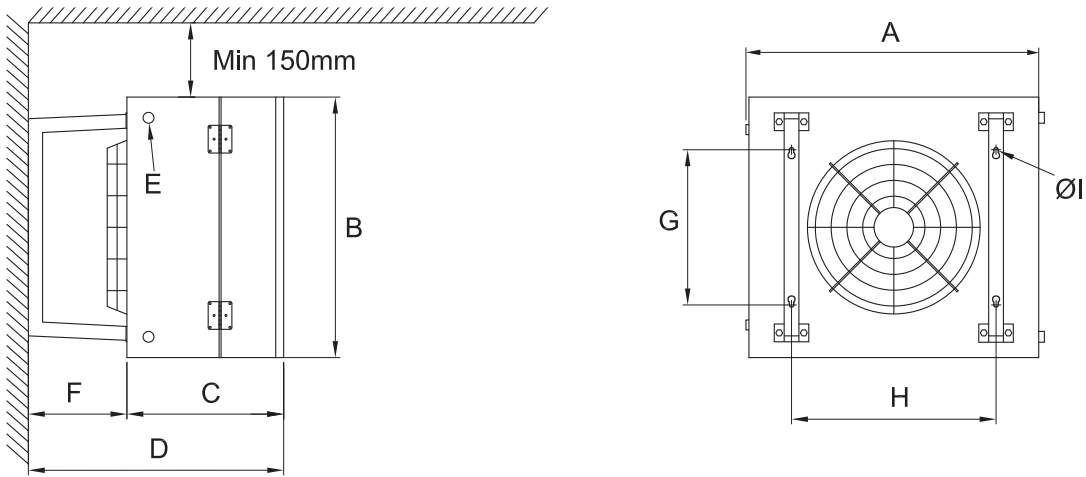

## AW D

Dimensions	A mm	B mm	C mm	D mm	E	F mm	G mm	H mm	Ø I
AW D22	585	535	395	705	G 3/4"	250	330	410	10
AW D42	740	660	395	725	G 3/4"	270	420	505	10



### Get In Touch

 Call: [0845 6880112](tel:08456880112)  
 Email: [info@adremit.co.uk](mailto:info@adremit.co.uk)

### Our Address

Puravent, Adremit Limited, Unit 5a, Commercial Yard,  
Settle, North Yorkshire, BD24 9RH



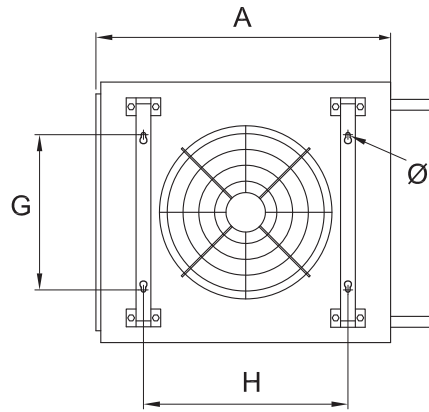
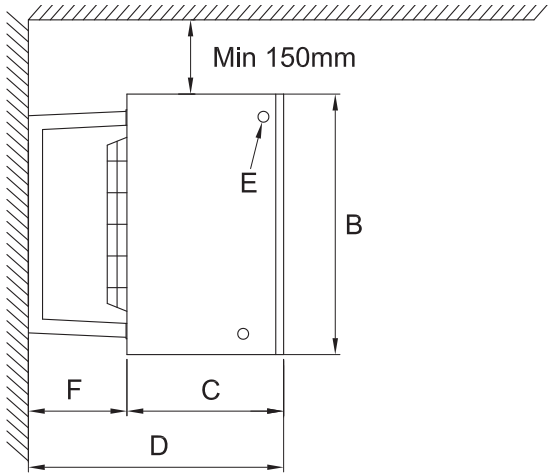

## AW Ex

Dimensions	A mm	B mm	C mm	D mm	E mm	F mm	G mm	H mm	Ø I
AW Ex22	550	530	380	630	Ø22	250	330	410	10
AW Ex42	705	655	430	700	Ø28	270	420	505	10



### Get In Touch

 Call: [0845 6880112](tel:08456880112)  
 Email: [info@adremit.co.uk](mailto:info@adremit.co.uk)

### Our Address

Puravent, Adremit Limited, Unit 5a, Commercial Yard,  
Settle, North Yorkshire, BD24 9RH



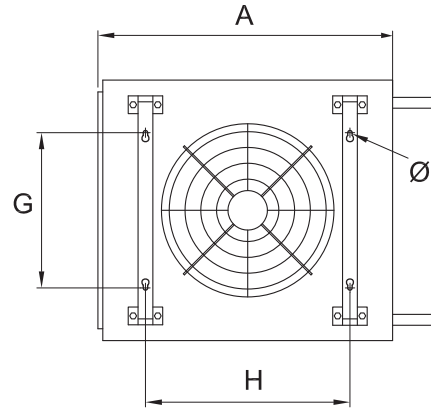
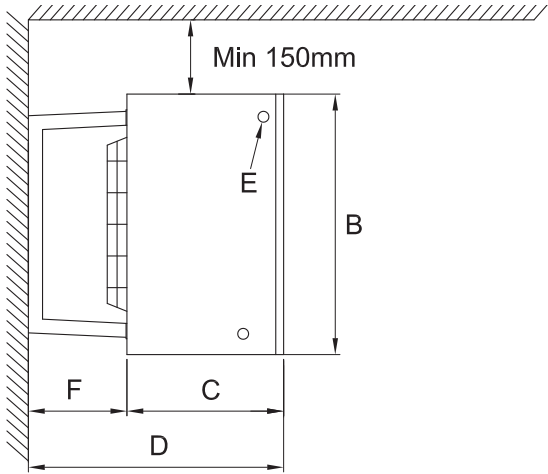

## AW H

Dimensions	A mm	B mm	C mm	D mm	E mm	F mm	G mm	H mm	Ø I
AW H22	550	530	380	630	Ø22	250	330	410	10
AW H42	705	655	430	700	Ø28	270	420	505	10



### Get In Touch

 Call: [0845 6880112](tel:08456880112)  
 Email: [info@adremit.co.uk](mailto:info@adremit.co.uk)

### Our Address

Puravent, Adremit Limited, Unit 5a, Commercial Yard,  
 Settle, North Yorkshire, BD24 9RH



**VEAB Heat Tech AB**

Phone: +46(0)451-485 00 • Fax: +46(0)451-410 80  
www.veab.com • veab@veab.com  
Sweden

**Get In Touch**



Call: [0845 6880112](tel:08456880112)

Email: [info@adremit.co.uk](mailto:info@adremit.co.uk)

**Our Address**

Puravent, Adremit Limited, Unit 5a, Commercial Yard,  
Settle, North Yorkshire, BD24 9RH