





# Kroll®



### Get In Touch

 Call: [0845 6880112](tel:08456880112)  
 Email: [info@adremit.co.uk](mailto:info@adremit.co.uk)

### Our Address

Puravent, Adremit Limited, Unit 5a, Commercial Yard,  
Settle, North Yorkshire, BD24 9RH



*Approved in a thousand ways and indestructible: the mobile warm air heaters from Kroll*



**You will find the suitable heater for every request:**

**The power range goes from 22 kW to 173 kW.**

**The Kroll mobile warm air heaters are perfect...**

- for heating halls, tents, sites...
- for keeping greenhouses, warehouses etc. frost free
- as additional heating during the cold season
- for drying new buildings
- etc.

**The Kroll mobile warm air heaters are...**

... immediately ready for use – everywhere. The models type M 25 and M 50 have an integrated oil tank and a heating cartridge. This makes them independent, space-saving

and immediately ready for use. The types M 70 to M 150 have a fuel supply pipe and a heated filter as standard and can also immediately be used using an external fuel tank.

**... reliable**

Thanks to the quality-brand oil burner and the powerful fan, an effective and efficient heating is ensured.

**... economical and reliable**

The quality-brand oil burner and the silent, yet powerful fan convert over 90 % of the energy into heat.

**... robust**

The high-quality materials and engineering guarantee a long lifespan.

**... easy to maintain**

All relevant elements and controls are easily accessible.

**... efficient**

The larger types M 50 to M 200 are equipped with high-power radial fans so they are particularly suitable to warm air hose systems. This helps to heat tents or building sites efficiently from the outside.

**Accessories:**

- warm air hoses: they can be connected either via an adaptor piece or via a distribution piece
- room thermostat for automatic operation.

**These heaters are also approved for operation with gas!**

**Get In Touch**

- Call:** 0845 6880112
- Email:** [info@adremit.co.uk](mailto:info@adremit.co.uk)

**Our Address**

Puravent, Adremit Limited, Unit 5a, Commercial Yard, Settle, North Yorkshire, BD24 9RH



*Our mobile warm air heaters are economical, reliable and can be used everywhere*



<b>Technical data</b>			<b>M 25</b>	<b>M 25 R</b>	<b>M 50</b>	<b>M 70</b>	<b>M 100</b>	<b>M 150</b>	<b>M 200</b>
Rated heat load	kW		25	25	51	71	100	140	188
Nominal heating efficiency	kW		22	22	46	64	90	125	173
Air delivery	m <sup>3</sup> / h		1150	1150	2900	4740	5400	7300	12000
External pressure	Pa		80	120	170	180	150	150	150
Oil consumption	kg/h		2,1	2,1	4,3	6,0	8,4	11,8	15,8
Electrical power consumption	kW		0,376	0,403	0,69	1,47	1,38	1,38	2,9
Electrical connection	V / A		230/1,3	230/1,75	230/4,4	230/6,4	230/6,1	230/6,1	230/13,5
Flue gas pipe	Ø mm		100	100	130	180	180	180	180
Air outlet opening	Ø mm		285	285	385	445	550	550	550
Tank content	liter		27	27	46	—	—	—	—
Weight without burner	kg		62	62	108	134	190	270	330
Dimensions	Width	mm	520	520	600	760	920	940	940
	Depth	mm	1060	1060	1350	1470	1850	2320	2400
	Height	mm	900	900	1050	1090	1260	1340	1570

#### Get In Touch

 Call: 0845 6880112  
 Email: [info@adremit.co.uk](mailto:info@adremit.co.uk)

#### Our Address

Puravent, Adremit Limited, Unit 5a, Commercial Yard, Settle, North Yorkshire, BD24 9RH



*Mobile warm air heaters:  
compact,  
easy to service  
and stackable*

**The mobile warm air heaters of the M-K serie have the well-proven characteristics of all Kroll heaters.**

Thanks to their axial fans with an extraordinary air delivery, a reliable and efficient heating is guaranteed. The M-K serie offers heating powers from 25,5 kW to 137 kW so you will find the right heater for every requirement. A solid construction and well-proven engineering guarantee a fault-free operation.

Furthermore, they have important advantages:

- The units are of compact construction, the wheels do not

disturb, so they are space-saving and easily stackable.

- Due to their construction, maintenance and service work is very easy: the burner is easily accessible.
- All important elements of the burner are protected against damage or bad weather by a burner cover.
- The M 25 K and M 50 K have a pre-heated nozzle connection which improves the combustion even with small nozzles.
- All units have an oil pre-heating device making them quickly ready for use also at very low ambient temperatures.

- The single-line fuel supply pipe with automatic ventilation ensures a smooth and comfortable operation.
- The snap-closings at the oil pipes make the heaters even more quickly ready for use.
- The units are manufactured in galvanized sheet metal and powder-coated.
- The combustion chamber and the heat exchanger are made of stainless steel.
- For an easy transport, all models are equipped with a jack ring.

<b>Technical data</b>			<b>M 25 K</b>	<b>M 50 K</b>	<b>M 70 K</b>	<b>M 100 K</b>	<b>M 150 K</b>
Rated heat load	kW		28	50	70	100	150
Nominal heating efficiency	kW		25,5	45,5	64	91,5	137
Air delivery	m <sup>3</sup> /h		1790	2900	4540	6050	8550
Oil consumption	kg/h		2,36	4,22	5,9	8,43	12,48
Electrical power consumption	kW		0,3	0,45	0,75	0,92	1,68
Electrical connection	V / A		230/1,3	230/2,3	230/3,8	230/4,6	230/7,8
Flue gas pipe	Ø mm		130	130	180	180	180
Air outlet opening	Ø mm		300	400	400	520	555
Weight	kg		131	164	198	230	310
Dimensions	Width	mm	520	630	670	770	870
	Depth	mm	1590	1750	1850	1950	2395
	Height	mm	980	1050	1160	1245	1310

**Get In Touch**

Call: 0845 6880112  
Email: [info@adremit.co.uk](mailto:info@adremit.co.uk)

**Our Address**

Puravent, Adremit Limited, Unit 5a, Commercial Yard,  
Settle, North Yorkshire, BD24 9RH

# The mobile heating unit HM 200 from Kroll: Immediately available heat



## Mobility and there with quick readiness for operation is the main characteristic of the Kroll mobile heating unit HM 200.

It is extremely suitable for use in various locations, such as tents, major construction sites, warehouses etc., and as additional, temporary or replacement heating unit.

The Kroll heating unit HM 200 is compactly constructed. There are no parts or connections, such as the air inlet/exhaust, protruding over the area of the HM 200, making the unit easily stackable, transportable and reducing the opportunity for any damage. It can easily be moved by a fork lift, with its "pallet-type" base it can easily be moved wherever it is needed. It fits on a standard lorry and is easily and safely stackable, a fact, that is especially interesting for rental companies.

All components of the unit, such as the burner, ventilator, control box etc. are enclosed within the robust housing. The heating unit is therefore protected against abuse or misuse by any unauthorised persons.

Various burners options are available: kerosene, gas, multi-oil or rapeseed-oil.

The heating unit works economically: The energy-transmission is effected directly without a medium like water or vapour, eliminating any danger of freezing.

This direct firing converts up to 92% of the energy into heat. The unit can operate in various configurations with recirculated-air, fresh-air or a mixture of both.

The high pressure of 350 Pa allows the connection of long ductings or pipes. The warm-air distribution can be effected via one or more warm air ducts at the same time. This feature gives you more options in locating the unit on site. The housing is galvanised, and painted in a colour similar to RAL 7047.

The installation is easy to maintain, all component parts are

positioned in a clearly arranged manner, and, thanks to removable side-panels, easy to reach.

Accessories available to complete the HM 200 package:

- heating cartridge for tank to preheat the oil.
- room thermostat for close control of the area to be heated.
- weekly timer for day/night control of the unit.

<b>Technical data</b>			<b>HM 200</b>
Rated heat load		kW	188
Rated heating power		kW	173
Air rate		m <sup>3</sup> /h	10500
Pressure max.		Pa	350
Consumption max.	Heating oil EL	kg/h	15,8
	Propane	kg/h	14,5
	Natural gas	kg/h	21,1
Temperature increase (ΔT)		Kelvin	60
Absorption of electrical power		kW	3,25
Electrical connection		V / N / A	400 / 3 / 13,5
Fuses (to be done by customer)		A	3 x 16
Flue gas pipe		Ø mm	180
Air intake and outlet		Ø mm	550
Length / width / height		mm	2400 / 820 / 1450
Weight		kg	615

## Get In Touch

Call: 0845 6880112  
Email: [info@adremit.co.uk](mailto:info@adremit.co.uk)

## Our Address

Puravent, Adremit Limited, Unit 5a, Commercial Yard,  
Settle, North Yorkshire, BD24 9RH

# Warm air heaters in special design



The robust mobile warm air heaters from Kroll with a heating power range from 18 to 36,8 kW are perfect to heat and ventilate:

- tents
- shelters
- etc.

They are highly appreciated by various disaster control organizations such as

- The Red Cross

- the army
- etc.

**The mobile warm air heaters from Kroll are...**

**... designed for operation at extremely cold ambient temperatures.**

The can be operated at a temperature of up to  $-32^{\circ}\text{C}$ , due to their pre-heated oil filter, their special thermostat and their stainless steel

combustion chamber.

So you can create heat also under the most extreme conditions.

**... reliable**

Our warm air heaters are robust and well-engineered. Safe operation is ensured by the pre-heated oil filter and the oil tanks.

<b>Technical data</b>		<b>MP 20</b>	<b>MP 40</b>
Combustible		heating oil	heating oil
Rated heat load	kW	20	40
Rated heat power	kW	18,2	36,8
Air delivery	m <sup>3</sup> /h	1.150	2.100
Rise in temperature ( $\Delta T$ )	Kelvin	55	55
Oil consumption	kg/h	1,68	3,37
Electrical consumption	kW	0,6	1,0
Electrical connection	V/Hz	230/50-60	230/50-60
Protection class		IP 44	IP 44
Weight	kg	ca. 80	ca. 125
Tank content	liter	–	–

## Get In Touch



Call: 0845 6880112



Email: [info@adremit.co.uk](mailto:info@adremit.co.uk)

## Our Address

Puravent, Adremit Limited, Unit 5a, Commercial Yard, Settle, North Yorkshire, BD24 9RH

Approved for thousand times:  
the mobile warm air heaters  
for extreme operation



... **economical and environ-**  
mentally friendly. The use of quality-  
brand oil burners and silent, but  
powerful fans converts over 90 % of  
the energy into heat.

... **easy to use**  
Kroll offers a room thermostat for  
even more energy saving and  
more comfortable operation.

**Accessories:**

- Room thermostat
- CO monitor: Via a CO monitor,  
the value of CO in the room is  
checked. If this value becomes  
too high, the burner automati-  
cally stops.

- Warm air hoses:  
These can be connected via  
a connection piece or a  
transition piece.

More colors on request.

<b>Technical data</b>		<b>MM 25</b>	<b>MM 50</b>
Combustible		heating oil	heating oil
Rated heat load	kW	27	51
Rated heat power	kW	24	46
Air delivery	m <sup>3</sup> /h	1.150	2.900
Rise in temperature (ΔT)	Kelvin	78	54
Oil consumption	kg/h	2,3	4,0
Electrical consumption	kW	0,376	0,740
Electrical connection	V/A	230 / 1,75	230 / 3,8
Protection class		IP 44	IP 44
Weight	kg	73	125
Tank content	liter	27	27

**Get In Touch**

Call: 0845 6880112  
Email: [info@adremit.co.uk](mailto:info@adremit.co.uk)

**Our Address**

Puravent, Adremit Limited, Unit 5a, Commercial Yard,  
Settle, North Yorkshire, BD24 9RH



*With these "cannons",  
heating is very simple*



*Oil heaters with flue gas pipe.  
They are suitable for closed and  
poorly ventilated rooms. Fuel supply  
from the integrated tank via an  
integrated compressor with  
the models "MAK".*

<b>Technical data</b>		<b>MAK 15</b>	<b>MAK 25</b>	<b>MAK 40</b>	<b>MA 37</b>	<b>MA 55</b>	<b>MA 85</b>
Rated heat load	kW	14,50	26	38,55	36	52	84
Rated heat power	kW	11,8	21	31,88	31,70	45,80	73,10
Fan power	m <sup>3</sup> /h	650	800	1200	2000	2500	4500
Oil consumption	kg/h	1,15	2,20	3,05	2,88	4,16	6,64
Electrical consumption	Watt	180	390	520	460	460	800
Electrical connection	V/A	230/1,7	230/2,0	230/2,0	230/3,0	230/3,0	230/6,0
Flue gas pipe	Ø mm	100	140	150	150	150	150
Tank content	liter	30	46	46	51	51	100
Length	mm	860	930	1065	1188	1405	1680
Width	mm	485	560	560	620	620	690
Height	mm	570	625	625	790	790	938
Weight	kg	35	43	40	70	76	121
Air outlet opening	Ø mm	209	259	259	308	308	443

#### Get In Touch

 Call: [0845 6880112](tel:08456880112)  
 Email: [info@adremit.co.uk](mailto:info@adremit.co.uk)

#### Our Address

Puravent, Adremit Limited, Unit 5a, Commercial Yard,  
Settle, North Yorkshire, BD24 9RH





# The Kroll oil heaters convince by their versatility



*Oil heaters without flue gas pipe. They are suitable for outdoor use or in well-ventilated rooms and have a degree of efficiency of 100 %. Fuel supply from the integrated tank via an integrated compressor with the models "GK". With the models "GP" via an integrated high-pressure pump.*

<b>Technical data</b>		<b>GK 20</b>	<b>GK 28</b>	<b>GK 40</b>	<b>GK 60</b>	<b>GP 67</b>	<b>GP 115</b>
Rated heat load	kW	23	28	43	61,3	66	115
Fan power	m³/h	400	500	1050	1300	2800	4800
Oil consumption	kg/h	1,97	2,37	3,64	4,85	5,22	9,12
Electrical consumption	Watt	230	280	380	550	460	800
Electrical connection	V/A	230/1,0	230/1,6	230/2,0	230/3,0	230/3,0	230/6,0
Tank content	liter	21	30	46	46	51	100
Lenght	mm	830	860	930	1065	1405	1680
Width	mm	430	485	560	560	620	690
Height	mm	465	530	615	625	750	898
Weight	kg	26	31	37	45	65	101

## Get In Touch

 Call: [0845 6880112](tel:08456880112)  
 Email: [info@adremit.co.uk](mailto:info@adremit.co.uk)

## Our Address

Puravent, Adremit Limited, Unit 5a, Commercial Yard, Settle, North Yorkshire, BD24 9RH



*Kroll radiant heater:  
instant heat where  
and whenever you  
need it...*



**The infrared oil heater IR 33 is practical, well proven and well engineered. It gives warmth where it is needed without air movement.**

It is particular suitable for drying damp walls and corners, de-icing of machines and tubes, as well as dust free drying of materials... The IR 33 is ideal for any situation and will soon become indispensable for you.

**Wherever you need dust free heating, the IR 33 is the perfect solution.**

The unit is quickly and flexibly applicable. You just need a plug and you can start it. Heating during the night is no problem – with the integrated oil tank the IR 33 is independent. The heating radiator has a compact size and does not need a lot of space. The radiator is variably rotatable. The use of a quality burner and the high temperature ensures, that almost all exhaust fumes are

burned away, the combustion is almost free of exhaust fumes and therefore you can use the IR 33 in well-ventilated rooms. The solid construction of the water proof stainless-steel housing and the high quality glowing grille of heat resistant stainless-steel, gives the IR 33 a long life. Its maintenance cost is low.

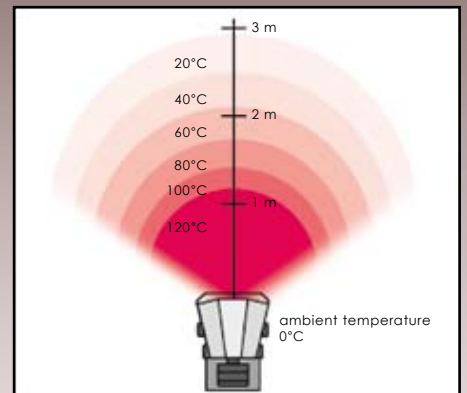

The diagram shows the temperature in relation to the object to be heated.

<b>Technical data</b>		<b>IR 33</b>
Heating power	kW	33
Oil consumption	kg/h	2,78
Tank content	liter	46
Electrical connection	V/A	220/1,5
Weight	kg	98
Dimensions		
Width	mm	680
Length	mm	940
Height	mm	990

**Get In Touch**

Call: 0845 6880112  
 Email: [info@adremit.co.uk](mailto:info@adremit.co.uk)

**Our Address**

Puravent, Adremit Limited, Unit 5a, Commercial Yard, Settle, North Yorkshire, BD24 9RH



# The Kroll gas fired heaters meet your wishes...



## They are ...

### ... environmentally beneficial

By nature, gas is an ecologically beneficial fuel. Kroll gas fired heaters burn almost inodorously and are nearly residue free.

### ... efficient

The units burn with high efficiency. A room thermostat can be delivered so that energy will be saved.

### ... variable

The standard of performance ranges

from 10 to 113 kW. This means it is the appropriate unit for any possible place of operation.

### ... sophisticated

Every unit has got a pressure controller. End fittings will be delivered as well. All of them are in accordance with the German Industrial Norm DIN 30697, thus in accordance with the European Norm CE.

### ... safe

The gas flame is permanently supervised

by thermocouples. The gas supply stops immediately as soon as the gas flame would go out. And the thermostat prevents the unit from overheating.

### ... unlikely to require much maintenance.

Robust technology and extremely high manufacturing quality ensure flawless operation.

<b>Technical data</b>		<b>P 10</b>	<b>P 15</b>	<b>P 30 PX 30 VA</b>	<b>P 43 PX 43 VA</b>	<b>P 60 PX 60 VA</b>	<b>P 80 PX 80 VA</b>	<b>P 100 PX 100 VA</b>
Heating power	kW	10-10,8	15,0	12,4-31,2	26,6-43,5	34,9-58,4	50,0-52,1	59-113
Fitting pressure	bar	0,3	0,7	1,5	2,0	2,0	2,0	2,0
Fan power	m <sup>3</sup> /h	300	300	750	850	1800	2450	330
Motor power	Watt	50	50	90	90	110	130	130
Electrical connection	V/Hz	220/50	220/50	220/50	220/50	220/50	220/50	220/50
Length	mm	390	490	530	690	780	925	925
Width	mm	180	180	280	280	370	270	370
Height	mm	270	270	400	400	520	520	520
Weight	kg	5	6	11,5	13	20	23	23
Consumption	kg/h	0,78	1,35	0,98-2,46	2,1-3,43	2,75-4,61	3,95-6,48	4,16-8,22

## Get In Touch

Call: [0845 6880112](tel:08456880112)  
 Email: [info@adremit.co.uk](mailto:info@adremit.co.uk)

## Our Address

Puravent, Adremit Limited, Unit 5a, Commercial Yard,  
 Settle, North Yorkshire, BD24 9RH



*The large hood reflects heat to an area of about 6 m*

**In the cool transition periods spring and autumn, the Kroll patio heater quickly becomes indispensable.**

The unit is perfect for the heating of balconies, terraces, outdoor areas of pubs, market stands etc.

The principle is simple and convincing: The patio heater (run by LPG) distributes the infra red heat down.

The heater is easy to install and quickly ready for operation. The gas bottle and the connection parts are hidden in the foot. The gas supply is done by the low-pressure controller with hose-breaking

protection. The piezo ignition reliably starts the heater, the heating power can be adjusted continuously by a adjustment knob.

The delivered gas protection valve interrupts the gas supply in case the heater should tepple over.

The Kroll patio heater provides heating for industrial and private outdoor areas during the cold transition periods. The large hood reflects the heat to an area of about 6 m. Operation is cheap, environmentally beneficial and efficient with LPG.

Dismounting the heater is also simple. For transport or storage, the support can be pushed together to about 1,60 m overall heighth. High-quality material such as stainless steel and aluminium give the heater its good look and grant a long lifespan.

New: With gas protection valve and hose-breaking protection!

DIN EN 14543: 2005



**Technical data**

**W 12 VA**

Operation with LPG (propane or butane)	mbar	50
Heating power	kW	6,5-12,5
Consumption	g/ h	510-780
Weight	kg	ca. 17
Height	mm	2265
Hood diameter	mm	950

The unit is not suitable for indoor use. It has a type approval and a CE label.

**Get In Touch**

 **Call:** 0845 6880112  
 **Email:** [info@adremit.co.uk](mailto:info@adremit.co.uk)

**Our Address**

Puravent, Adremit Limited, Unit 5a, Commercial Yard, Settle, North Yorkshire, BD24 9RH

# The robust electric heaters from Kroll...



## ... are universal

The electric fan heaters are perfect for use in rather small rooms and in rooms of medium size. The smaller types are the ideal extra heaters in large rooms. They are designed for being operated in workshops, nurseries, shops, exhibition rooms, warehouses, site huts, or elsewhere on building sites. There, they provide comfortable heat in spring and in autumn, or, if there is a sudden onset of cold weather. They can be used as frostcontrol, too.

## ... are economical

The heat is dispensed efficiently and concentratedly to the ambient air by a powerful fan.

## ... are comfortable

The electric fan heaters do not use up any oxygen. They do not give off any unpleasant smell at all. Because of this, they can also be operated in rooms which have bad or even no means of ventilation. They are ready for use everywhere, and at once. Temperature can be adjusted and is controlled by a thermostat. In summer, they can be used for ventilating rooms as well.

## ... are rugged and safe

All appliances are VDE-checked and thermally protected. Nothing can burn out. The enclosed heating elements have got a stainless jacket, the boxes consist of galva-

nized steel sheet and, in addition, they are stove-enamelled. They are stable and would not tilt over, if someone might bump against it.

## ... are mobile

Thanks to their small dimensions the electric fan heaters can be taken everywhere. You will find a place for them even in very confined space, and they will not stand in the way.

<b>Technical data</b>			<b>E 3</b>	<b>E 8</b>	<b>E 12</b>	<b>E 18</b>
Heating power		kW	3	4/8	6/12	12/18
Air delivery		m <sup>3</sup> /h	185	420	735	960
Temperature rise (ΔT)		Kelvin	48	28/56	24/48	36,5/55
Electrical connection		V	230	400/3N	400/3N	400/3N
Electrical consumption		A	13,5	12	16,5	24,5
Dimensions	Length	mm	330	530	666	666
	Width	mm	185	285	320	320
	Height	mm	270	395	435	435
Weight		kg	6,35	15,5	20,5	23,5

## Get In Touch



Call: 0845 6880112



Email: [info@adremit.co.uk](mailto:info@adremit.co.uk)

## Our Address

Puravent, Adremit Limited, Unit 5a, Commercial Yard,  
Settle, North Yorkshire, BD24 9RH



**The Kroll concrete silo heating systems do not only solve the problem of frozen aggregates but also allow the production of warm concrete during the freezing periods.**

Kroll concrete silo heating systems ensure a trouble-free mixing in winter. In the building trade, the cold season generates a lot of pro-

blems. Snow and frost cause delays or even bring processes to a standstill. In this respect, the problems of frozen aggregates and freezing water are of crucial importance. In order to solve this problem, Kroll offers tailor-made heating systems for concrete mixing plants.

Kroll concrete silo heating systems are individual. They can be integrated into all silo

types, e.g., tower silos, tandem silos or star silos.

The concrete silo heating systems are delivered as a unit of hot-air and hot-water heater. If necessary, all single elements can be delivered separately. All single elements can also be integrated stationary into existing rooms. The power specifications will be fitted to each specific project.

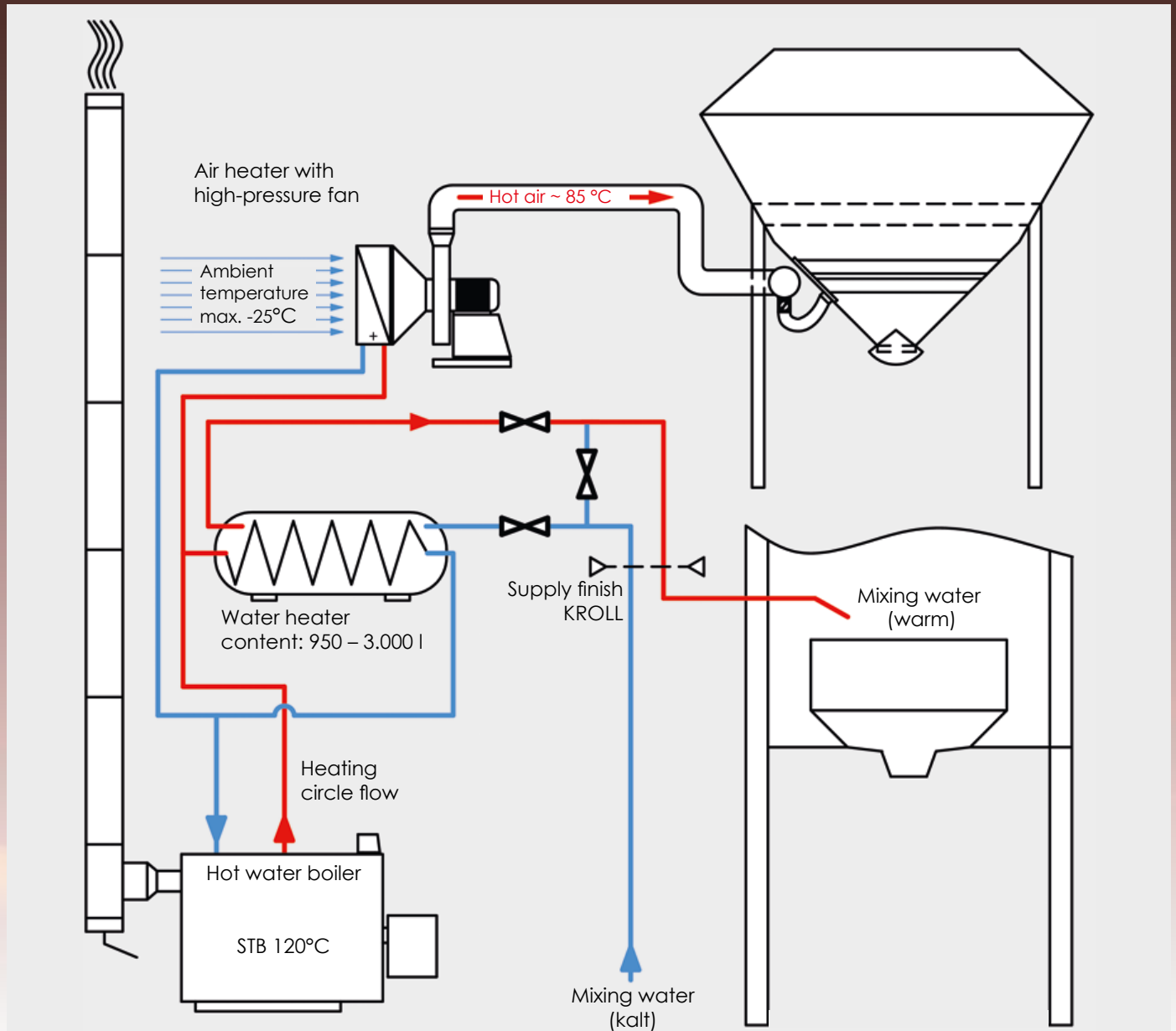

## Get In Touch

Call: 0845 6880112  
Email: [info@adremit.co.uk](mailto:info@adremit.co.uk)

## Our Address

Puravent, Adremit Limited, Unit 5a, Commercial Yard,  
Settle, North Yorkshire, BD24 9RH

# Hot air for aggregates



## The hot air heating unit WL

This unit serves to warm up construction aggregates. The hot air is fed through pipes into the silo chamber and there, under high pressure, is blown at the aggregates through special nozzles. The volume of air can be regulated separately for every silo chamber by using dampers. The construction aggregates may be washed at any time even during severe frost.

The following types of combustibles are possible:

- Oil (with oil burner)
- Gas (with gas burner)
- Thermal oil with heat exchanger
- Thermal oil/air heat exchanger (e.g., in existing thermal oil heating systems)
- Steam with heat exchanger
- Steam/air heat exchanger (e.g., in existing steam generators)

The hot air medium has the following advantages:

- The unit does not freeze
- No additional moisture is mixed with the aggregates
- No warm-water preparation is necessary
- You do not have to supervise the unit all the time
- Automatic operation and little space needed

## Hot air heating systems (Extract of the programme)

Type		WL 100	WL 160	WL 220	WL 320	WL 480
Air volume	m <sup>3</sup> /h	2650	4600	6200	9000	12000
Temperature of outblown air	°C	89	87,5	87,5	90	87,5
Heating power	kW	92	158	213	317	480
Fan pressure	Pa	5370	5370	6850	7410	6850

other power ranges on request

It supplies warm water for the mixing procedure as well as for the transport inside the mixing vehicles.

The control of the mixing water temperatures is done from the control desk of the mixing master.

## Warm water unit (Extract of the programme)

Type		950	1500	2000	2500	3000
Tank content	liter	950	1500	2000	2500	3000
Power	kW	100-180	140-240	180-300	220-420	220-420
Max. continuous output	at 45 °C/10 °C	4420	5900	7370	10320	10320
	at 70 °C/10 °C	2580	3440	4300	6020	6020

Kroll has got many years of experience by engineering many reliably working units. Profit from our knowledge!

## Get In Touch

Call: 0845 6880112  
Email: [info@adremit.co.uk](mailto:info@adremit.co.uk)

## Our Address

Puravent, Adremit Limited, Unit 5a, Commercial Yard, Settle, North Yorkshire, BD24 9RH



Kroll GmbH  
Pfarrgartenstraße 46  
D – 71737 Kirchberg / Murr  
Telefon 0049 (0)7144 / 830 200  
Telefax 0049 (0)7144 / 830 201  
e-mail [vertrieb@kroll.de](mailto:vertrieb@kroll.de)  
Internet: [www.kroll.de](http://www.kroll.de)



Mobile warm air heaters 09/09  
Technical data subject to change

*More information on the Kroll  
product range on: [www.kroll.de](http://www.kroll.de)*

#### Get In Touch

 Call: [0845 6880112](tel:08456880112)  
 Email: [info@adremit.co.uk](mailto:info@adremit.co.uk)

#### Our Address

Puravent, Adremit Limited, Unit 5a, Commercial Yard,  
Settle, North Yorkshire, BD24 9RH