

⚡ Electrically heated 300-900 W

18 models



Thermoplus

Slim radiant heater for protection against cold draughts

Application

Thermoplus is mounted above windows and gives an efficient protection against cold draught. The slim shape also makes it suitable for heating areas with limited space, like for example bathrooms. Thermoplus can furthermore be a cost-effective and flexible alternative to floor heating.

Comfort

Radiant heaters give a soft, pleasant heat and individual comfort can be created with spot and zone heating. They also provide excellent protection against cold draught from windows. No moving parts mean a silent system that does not cause air movements and the hygiene is improved when the spread of dust, bacteria or odours is reduced.

Operation and economy

Radiant heaters have an easy and flexible installation and require a minimum of maintenance. Ceiling mounting leaves the walls free and increases safety. They give instant heat and the room temperature can be reduced with maintained comfort. The enamelled front panel gives an enhanced heating emission.

Design

Thermoplus is covered with white enamel which makes it discreet and scratch-resistant. The slim shape makes it practically invisible when mounted in the ceiling angle.

Product specifications

- Mounted above the window.
- Brackets for wallmounting are included. Fixtures for ceiling mounting are extra.
- Front panel of white scratch-resistant enamelled aluminium. Colour: RAL 9010. Rear panel of hot zinc-plated steel panels.
- Cable entry on the left side seen from the front.

Thermoplus is available in three versions:

- Type EC, for dry rooms. Controlled by a separate thermostat or output control. IP20.
- ECVT, for wet rooms. With a built-in cord switch and thermostat. IP44.
- ECV, for wet rooms. Primarily designed for connection as slave device to ECVT, but can also be controlled separately using the same methods as for EC. IP44.

Installation height

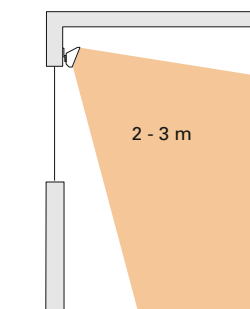

Design and specifications are subject to change without notice.

Get In Touch

☎ Call: 0845 6880112
✉ Email: info@adremit.co.uk

Our Address

Puravent, Adremit Limited, Unit 5a, Commercial Yard, Settle, North Yorkshire, BD24 9RH



The space close to the window can be used when the cold draught is eliminated. Mounted close together several Thermoplus form a continuous plinth.



Thermoplus is used for cold draught protection. The radiant heat moulding is very discreet as it is positioned high up along a beam.



Thermoplus take up minimum space mounted in the ceiling angle.



Thermoplus creates a pleasant heat in the room and on the floor and can be a cost effective alternative to floor heating.

Get In Touch

Call: 0845 6880112
Email: info@adremit.co.uk

Our Address

Puravent, Adremit Limited, Unit 5a, Commercial Yard, Settle, North Yorkshire, BD24 9RH



Thermoplus

Technical specifications | Thermoplus EC. For dry rooms. ⚡

Type	Heat output [W]	Voltage [V]	Amperage [A]	Surface temperature [°C]	Dimensions LxHxD [mm]	Weight [kg]
EC45021	450	230V~	2,0	180	1076x100x90	2.6
EC45031	450	400V~	1,1	180	1076x100x90	2.6
EC60021	600	230V~	2,6	180	1505x100x90	3.7
EC60031	600	400V~	1,5	180	1505x100x90	3.7
EC75021	750	230V~	3,3	180	1810x100x90	4.4
EC75031	750	400V~	1,9	180	1810x100x90	4.4
EC90021	900	230V~	3,9	180	2140x100x90	4.8
EC90031	900	400V~	2,3	180	2140x100x90	4.8

Technical specifications | Thermoplus ECVT. For wet rooms. Built-in thermostat, electric switch, signal lamp. ⚡

Type	Heat output [W]	Voltage [V]	Amperage [A]	Surface temperature [°C]	Dimensions LxHxD [mm]	Weight [kg]
ECVT30021	300	230V~	1,3	180	870x100x90	2.6
ECVT55021	550	230V~	2,4	180	1505x100x90	4.3
ECVT55031	550	400V~	1,4	180	1505x100x90	4.3
ECVT70021	700	230V~	3,0	180	1810x100x90	5.0
ECVT70031	700	400V~	1,8	180	1810x100x90	5.0

Technical specifications | Thermoplus ECV. For wet rooms. Connected as slave device to ECVT. ⚡

Type	Heat output [W]	Voltage [V]	Amperage [A]	Surface temperature [°C]	Dimensions LxHxD [mm]	Weight [kg]
ECV30021	300	230V~	1,3	180	870x100x90	2.3
ECV55021	550	230V~	2,4	180	1505x100x90	4.0
ECV55031	550	400V~	1,4	180	1505x100x90	4.0
ECV70021	700	230V~	3,0	180	1810x100x90	4.7
ECV70031	700	400V~	1,8	180	1810x100x90	4.7

Protection class Thermoplus EC: (IP20) normal design. Thermoplus ECVT and ECV: (IP44) splash-proof design. CE compliant.

Get In Touch

Call: 0845 6880112
Email: info@adremit.co.uk

Our Address

Puravent, Adremit Limited, Unit 5a, Commercial Yard,
Settle, North Yorkshire, BD24 9RH



Dimensions

Mounting on the wall

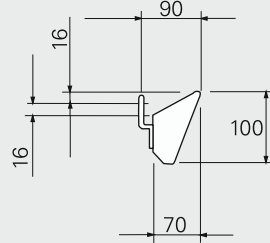

Type EC

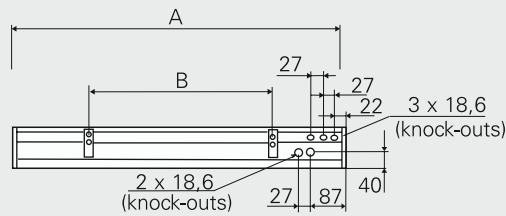

Type	A [mm]	B [mm]
EC450	1076	600
EC600	1505	900
EC750	1810	1200
EC900	2140	1800

Mounting on the ceiling

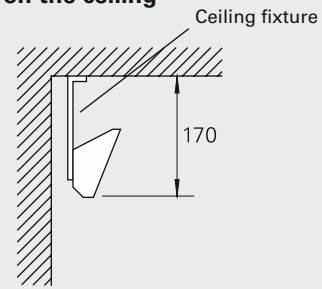

Type ECV, ECVT

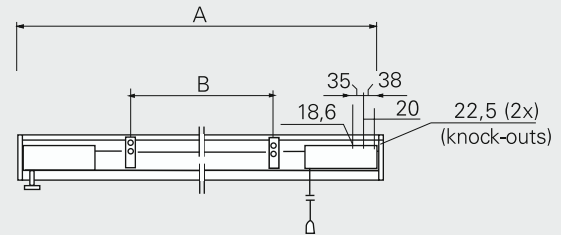

Type	A [mm]	B [mm]
ECV(T)300	870	400
ECV(T)550	1505	900
ECV(T)700	1810	1200

Positioning, mounting and installation

Mounting

Thermoplus among other things is used to protect against cold draughts from windows and is mounted horizontally above the window. In comparison to conventional radiators, Thermoplus is mounted above instead of below the window and is thus especially suitable for areas where there are children.

Two wall mounting brackets are included as standard. Fixtures for ceiling mounting are extra, TF1. For minimum mounting distance, see Fig. 1.

Connection

Thermoplus is intended for permanent installation. There is a 5-poled plinth (4 x 6 mm² + earth) in the terminal box which allows bridge connection. Several Thermoplus can be connected to one thermostat or electric heating control.

Type EC is controlled by a separate thermostat or output control. ECVT has a built-in cord switch and thermostat. ECV is primarily designed to be a slave connected to ECVT, maximum 3600 W at 230 V~ or 4000 W at 400 V~, but can also be regulated separately using the same methods as for EC.

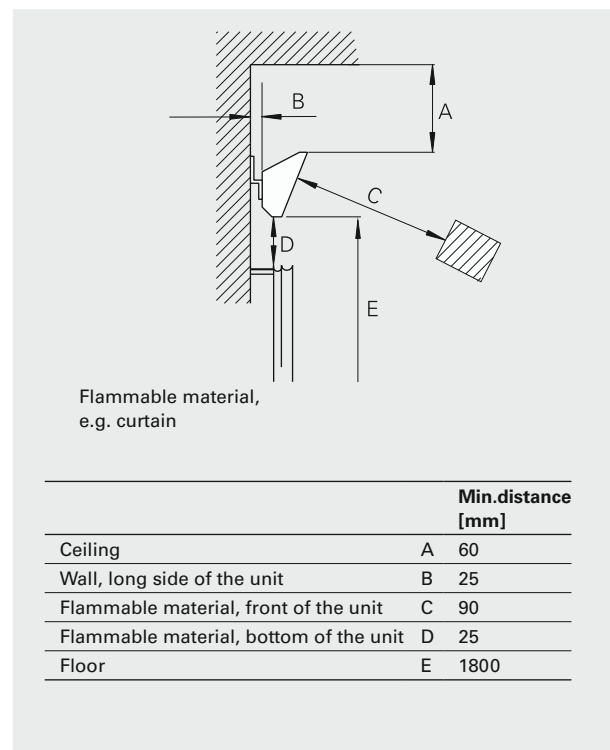

Fig. 1: Minimum mounting distance.

Get In Touch

Call: 0845 6880112
Email: info@adremit.co.uk

Our Address

Puravent, Adremit Limited, Unit 5a, Commercial Yard, Settle, North Yorkshire, BD24 9RH

Effect on the temperature near windows

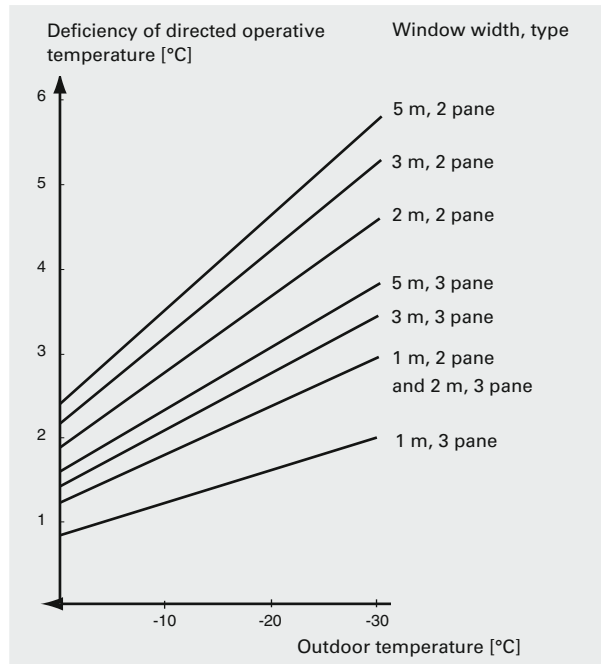

Temperature differentials

The diagram to the left refers to temperature loss through a window that is 1.7 metre high and is measured 1.0 metre into the room from the centre of the window.

Heat contribution

The contribution to operative temperature is measured at a ceiling height of 2.4 metres, one meter into the room from the centre of the window.

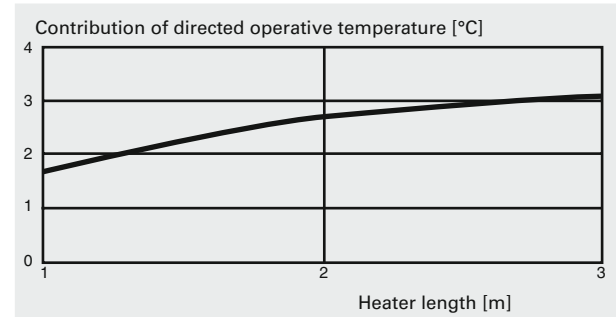

Control options

Output control

Stepless control that precisely adapts energy use to the current demand making it possible to benefit the most from radiant heating. This results in a soft comfortable heating and lower energy costs.

- ERP, electric heating control
- ERPS, electric heating control (slave)

Control by thermostat

The choice of thermostat depends on needs and environment. If the load exceeds the limits of the thermostats or if you want to control large systems, a contactor can be used.

- T10, electronic thermostat with concealed knob
- TKS16, thermostat with visible knob, 1-pole switch
- TD10, thermostat with digital display
- KRT1900, capillary room thermostat, IP55

Accessories

TF1, fixture for ceiling mounting

To mount Thermoplus on the ceiling.

OS1/2, protection net

The protection net prevents direct contact with the top of the heater and is of galvanized thread net. It is braced between the wall and the heater. Available in two lengths: 1070 and 1500 mm.

For further options, see section on thermostats and controls or contact Frico.

Controls and other accessories

Type	Description	HxWxD [mm]
ERP	Electric heating control	153x94x43
ERPS	Electric heating control (slave)	153x94x43
T10	Electronic thermostat	80x80x31
TKS16	Electronic thermostat, knob, 1-pole switch	80x80x39
TD10	Electronic thermostat, display	80x80x31
KRT1900	Capillary room thermostat, IP55	165x57x60
TF1	Fixture for ceiling mounting	
OS1	Protection net 1070 mm	L:1070
OS2	Protection net 1500 mm	L:1500

Get In Touch

Call: 0845 6880112
Email: info@adremit.co.uk

Our Address

Puravent, Adremit Limited, Unit 5a, Commercial Yard, Settle, North Yorkshire, BD24 9RH

Wiring diagrams Thermoplus

Internal wiring diagram EC

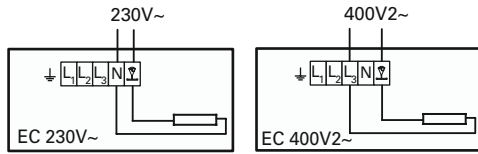

Internal wiring diagram ECVT

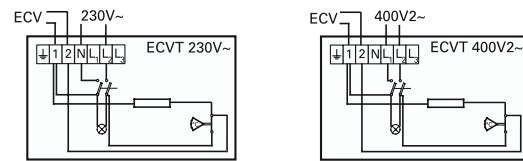

Output control

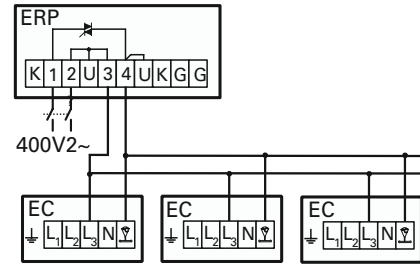
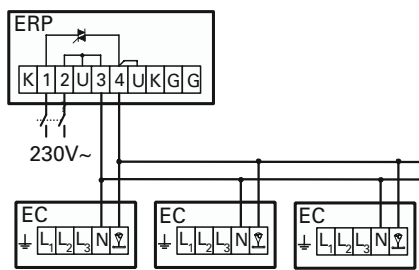

Control by thermostat

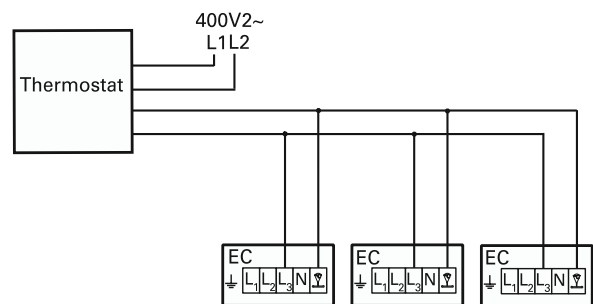
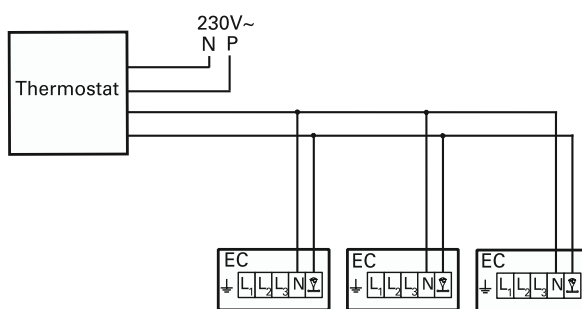

Design and specifications are subject to change without notice.

Get In Touch

Call: 0845 6880112
Email: info@adremit.co.uk

Our Address

Puravent, Adremit Limited, Unit 5a, Commercial Yard,
Settle, North Yorkshire, BD24 9RH