

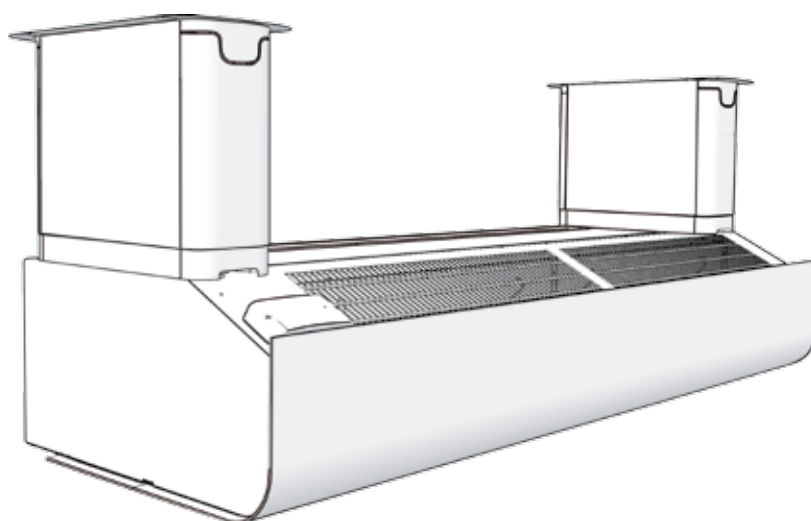

Original instructions

PA3DC/PA4DC
PA3DXT/PA4DXT



Get In Touch

 **Call:** [0845 6880112](tel:08456880112)
 **Email:** info@adremit.co.uk

Our Address

Puravent, Adremit Limited, Unit 5a, Commercial Yard,
Settle, North Yorkshire, BD24 9RH



- Installatören är ansvarig för att lämplig metod och infästningsmaterial används.
- The installer must ensure that the appropriate method and mounting materials are used
- Installatøren skal påse at riktig fremgangsmåte og installasjonsmateriell blir brukt.
- Der Installateur muss sicherstellen, dass eine adäquate Installationsmethode und geeignete Installationsmaterialien zur Anwendung kommen.
- L'installateur doit s'assurer que la méthode et le matériel d'installation utilisés conviennent.
- El instalador debe asegurarse de que se utilizan el método y materiales de instalación apropiados
- De installateur dient erop toe te zien dat de juiste methode en installatiematerialen worden gebruikt.
- Instalator powinien dopilnować, aby użyto odpowiedniej metody i materiałów montażowych.
- L'installatore deve assicurarsi che vengano utilizzati il metodo e i materiali di installazione adeguati.
- При монтаже соблюдайте рекомендуемый порядок сборки и используйте приложенные монтажные элементы

PA3DC / PA4DC

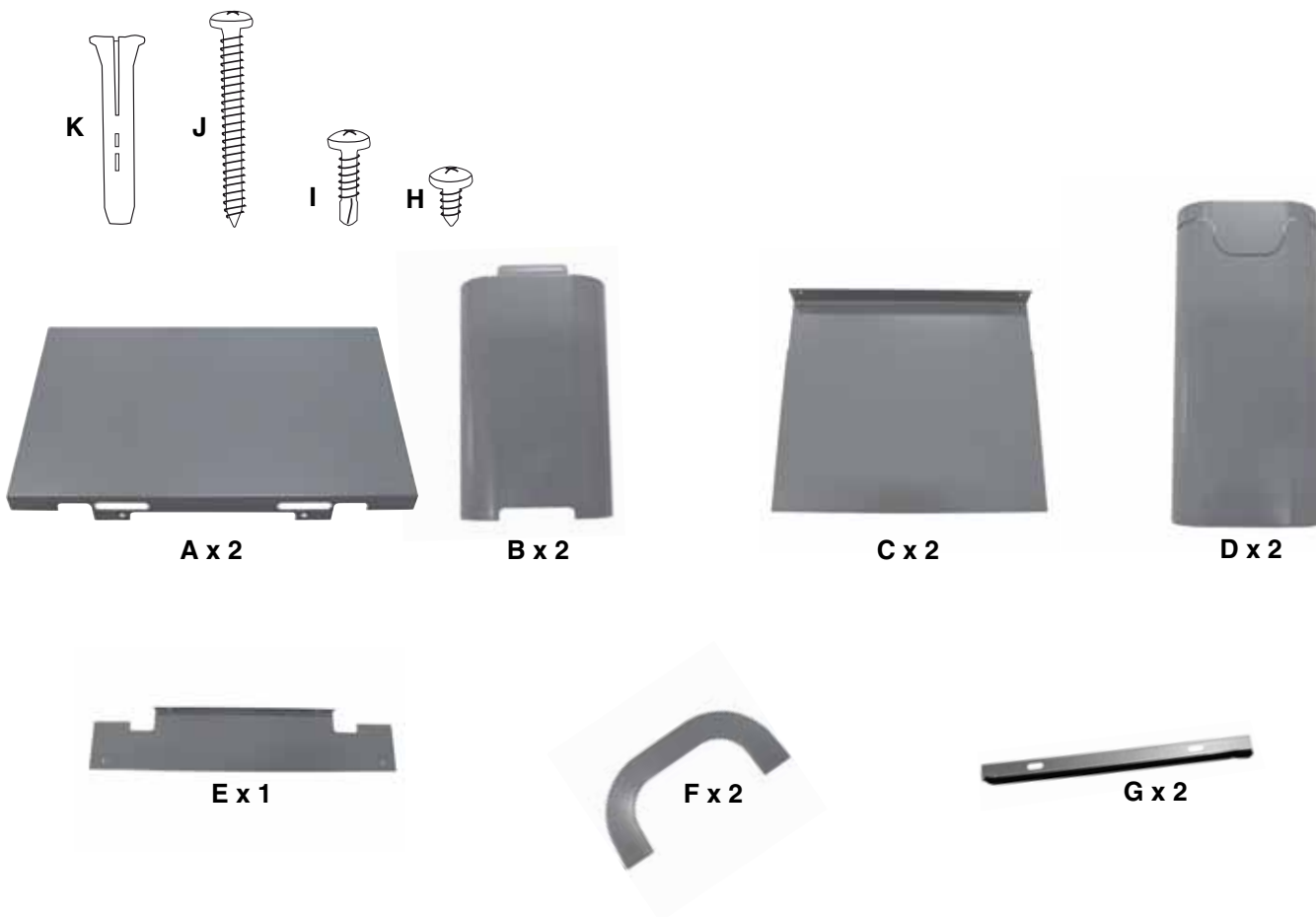

PA3DXT / PA4DXT



Get In Touch

 Call: 0845 6880112
 Email: info@adremit.co.uk

Our Address

Puravent, Adremit Limited, Unit 5a, Commercial Yard,
Settle, North Yorkshire, BD24 9RH



PA3DC / PA4DC + PA34TR

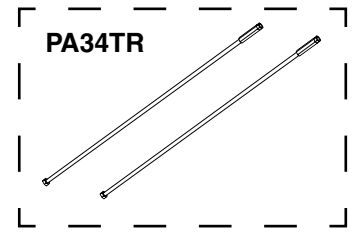

1 2 x A + 2 x B

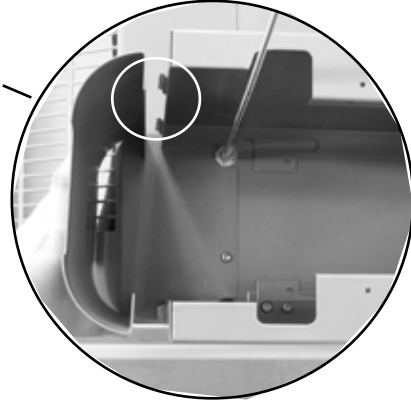

2

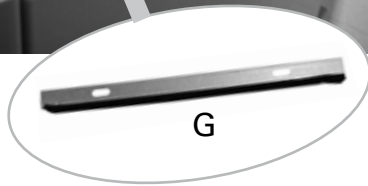



3

2 x I 



PA3DC / PA4DC + PA34TR P. 5

Get In Touch

 Call: 0845 6880112
 Email: info@adremit.co.uk

Our Address

Puravent, Adremit Limited, Unit 5a, Commercial Yard,
Settle, North Yorkshire, BD24 9RH





PA3DXT / PA4DXT



5



6

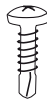
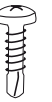

8

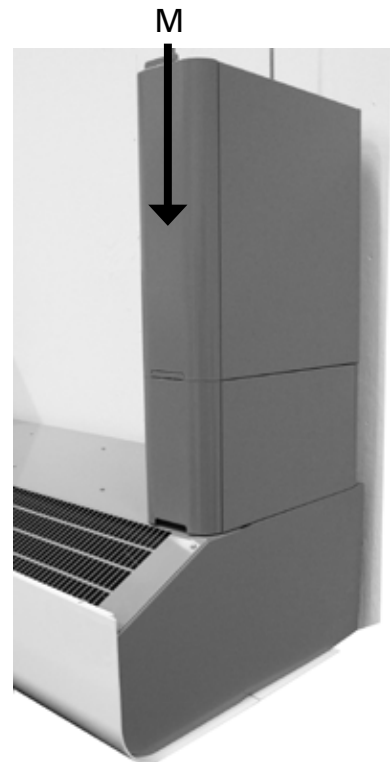

Forts. s.5 fig 4.
 Cont. p.5 fig 4
 Forts. s.5 fig. 4
 Forts. S.5, Abb. 4
 продолжение со стр.5, рис. 4

Suite de la page 5 fig 4
 Continúa de la pág. 5 figura 4
 Vervolg van p. 5, fig. 4
 Kont. ze str. 5 rys. 4
 Segue da p. 5 fig. 4

Get In Touch

Call: 0845 6880112
 Email: info@adremit.co.uk

Our Address

Puravent, Adremit Limited, Unit 5a, Commercial Yard,
 Settle, North Yorkshire, BD24 9RH



4

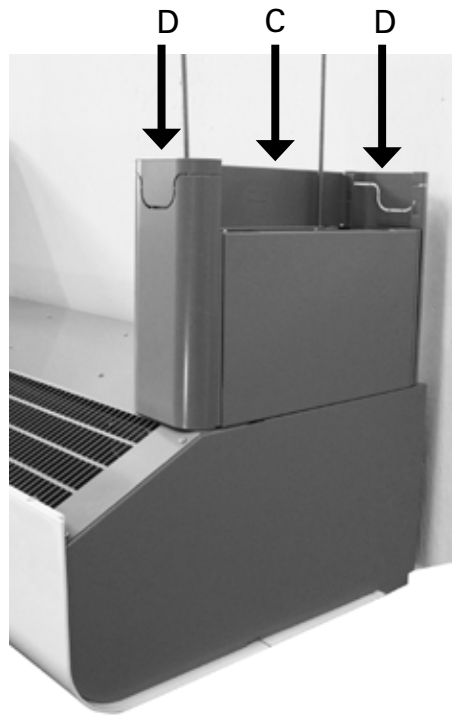
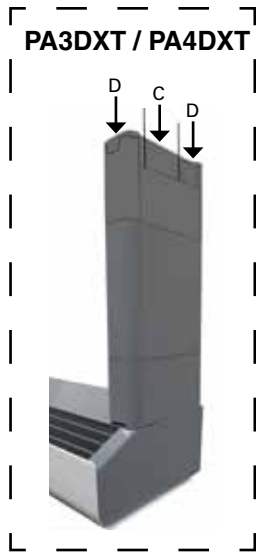

5

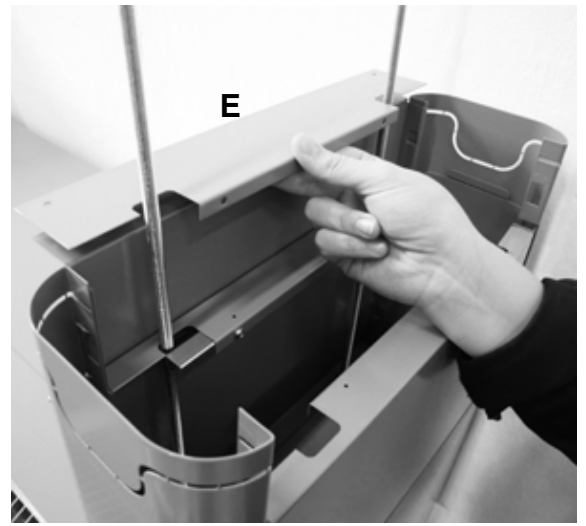



6

2 x F + 2 x H 



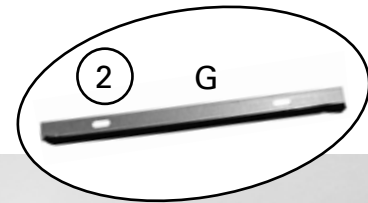

7

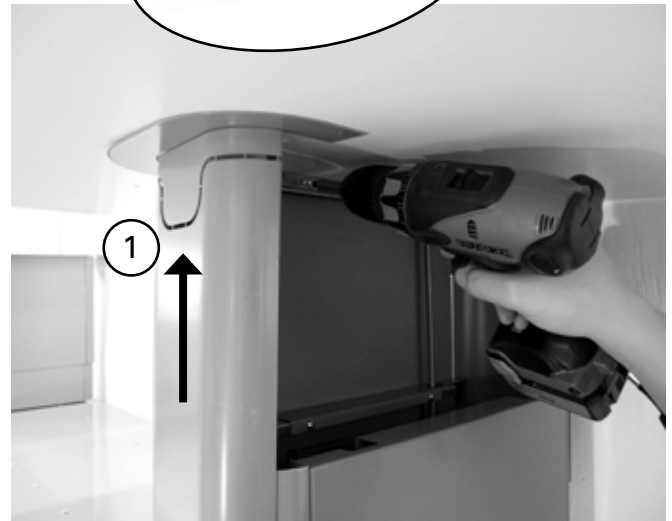

3  2 x I



Get In Touch

 Call: 0845 6880112
 Email: info@adremit.co.uk

Our Address

Puravent, Adremit Limited, Unit 5a, Commercial Yard,
Settle, North Yorkshire, BD24 9RH





8



9

2 2 x H 

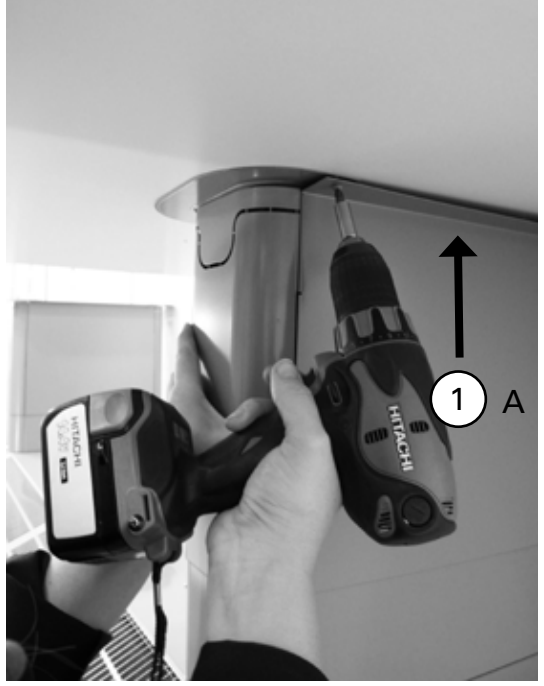

10





 2 x

11



6

Get In Touch

 Call: [0845 6880112](tel:08456880112)
 Email: info@adremit.co.uk

Our Address

Puravent, Adremit Limited, Unit 5a, Commercial Yard,
Settle, North Yorkshire, BD24 9RH





PA3DC / PA4DC

PA3DC / PA4DC + PA3WS / PA4WS

1

2 A + B

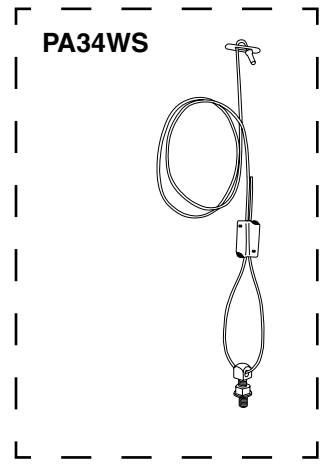

2

4 x 1 



3



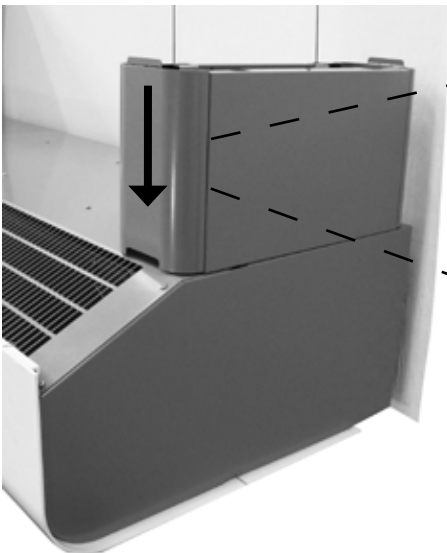

4

B



Get In Touch

 Call: [0845 6880112](tel:08456880112)
 Email: info@adremit.co.uk

Our Address

Puravent, Adremit Limited, Unit 5a, Commercial Yard,
Settle, North Yorkshire, BD24 9RH





5 2 x C + 2 x D



6

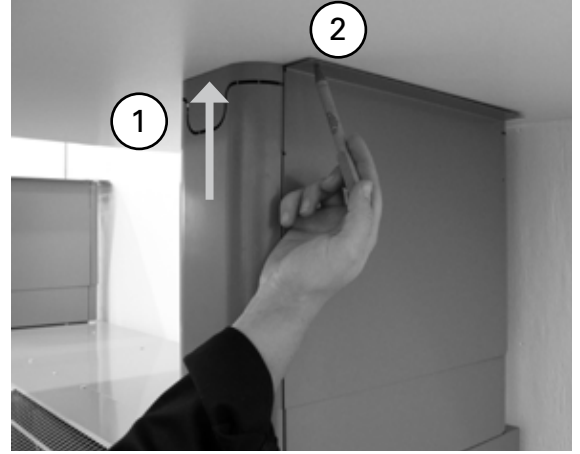

7

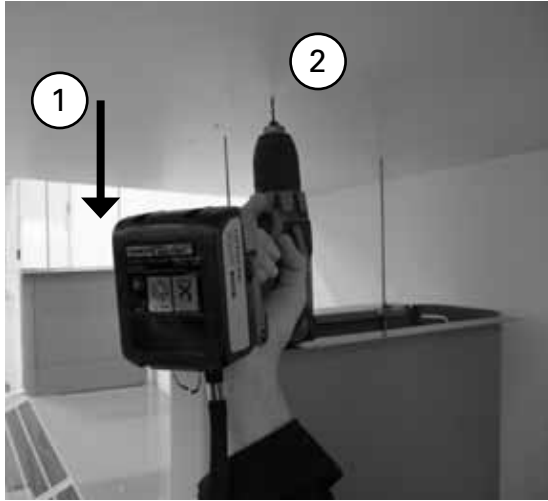

8

4 x K 

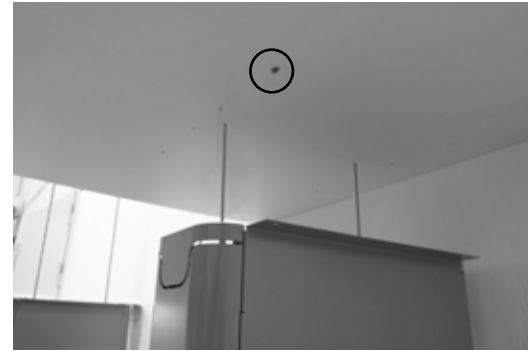

9

2 4 x J 

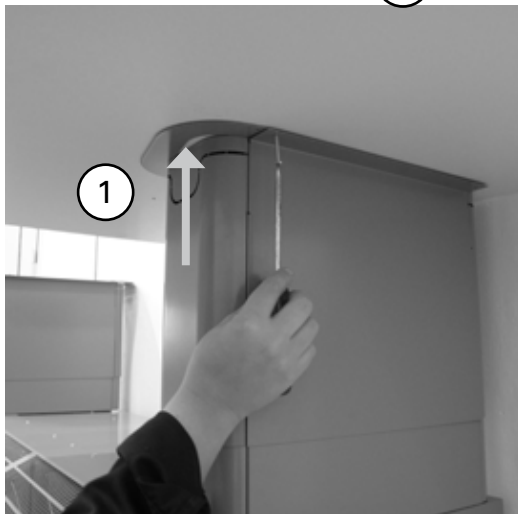

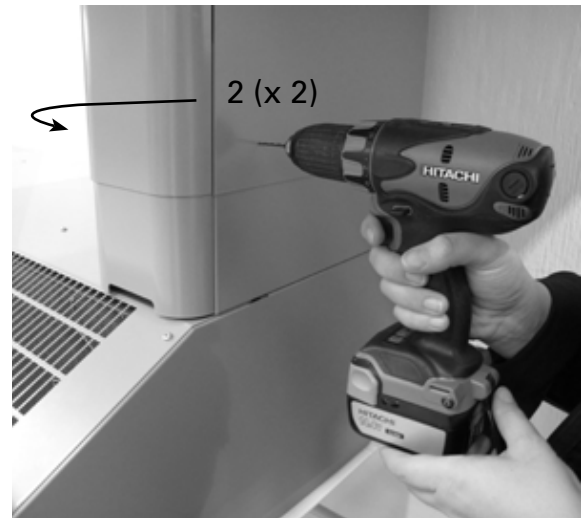

10



8

Get In Touch

 Call: 0845 6880112
 Email: info@adremit.co.uk

Our Address

Puravent, Adremit Limited, Unit 5a, Commercial Yard,
Settle, North Yorkshire, BD24 9RH





11



2 (x 2) x H



12



Get In Touch

 Call: [0845 6880112](tel:08456880112)
 Email: info@adremit.co.uk

Our Address

Puravent, Adremit Limited, Unit 5a, Commercial Yard,
Settle, North Yorkshire, BD24 9RH



Get In Touch



Call: [0845 6880112](tel:08456880112)



Email: info@adremit.co.uk



Our Address

Puravent, Adremit Limited, Unit 5a, Commercial Yard,
Settle, North Yorkshire, BD24 9RH





Get In Touch

 Call: [0845 6880112](tel:08456880112)
 Email: info@adremit.co.uk

Our Address

Puravent, Adremit Limited, Unit 5a, Commercial Yard,
Settle, North Yorkshire, BD24 9RH





Main office



Frico AB
Box 102
SE-433 22 Partille
Sweden

Tel: +46 31 336 86 00
Fax: +46 31 26 28 25
mailbox@frico.se
www.frico.se

**For latest updated information and information
about your local contact: www.frico.se**

Art. nr: 112961 140114

Get In Touch

 **Call:** [0845 6880112](tel:08456880112)
 **Email:** info@adremit.co.uk

Our Address

Puravent, Adremit Limited, Unit 5a, Commercial Yard,
Settle, North Yorkshire, BD24 9RH

