

DIMENSIONS

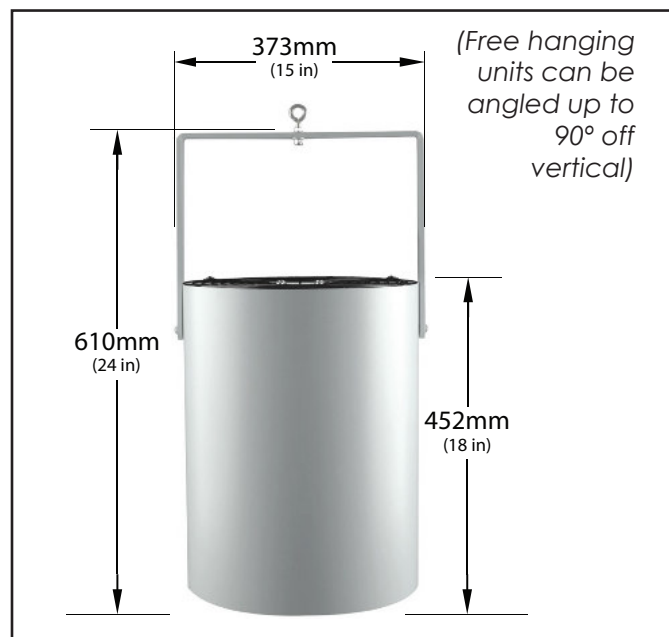

COVERAGE

- Ceiling Height = 12m - 14m (39 - 46 ft)
- Diameter = 11m - 14m (36 - 46 ft)
- Floor area = 100m² - 150m² (1,076 - 1,615 ft²)

MOTOR

- Single phase, permanent split capacitor, single speed (variable with optional speed control), axial motor
- Sealed bearings, no lubrication required

OPERATING TEMPERATURES

- Operating Temp = -25°C (-13°F) to 50°C (122°F)
- Thermal shut off = 135°C (275°F)
- Reset = 125°C (255°F)

HOUSING

- Aluminium cylindrical housing
- Powder coated
- Internal PC/ABS resin fixed blade stator
- 5VA flame rating

PROPERTIES

UNIT SIZE	Standard	
	Weight:	8.6 kgs (19 lbs)
	Height to Rim:	452 mm (18 in)
	Total Height:	610 mm (24 in)
	Diameter:	373 mm (15 in)

MOTOR	230V	
	Watts* @ 50 hz:	125
	RPM* @ 50 hz:	2,450
	CFM* @ 50 hz (m3/hr):	1,072 (1,821)
	AMPS* @ 50 hz:	0.54

*Motor data provided by motor manufacturer and is subject to change at anytime

NOISE LEVEL

- Floor Level = 0 - 44 dB(A)

INGRESS PROTECTION

- IP44 Rated

COLOUR

- Cool gray 2C - Off white as standard
- Can be tailor painted to your colour specifications

ACCESSORIES & OPTIONS

- Speed Controls - On/off speed controls allow for variable output from Airius unit. 1 AMP and 5 AMP controls available

WARRANTY

- 5 years parts and workmanship from shipping date
- 120 day money back guarantee (T's & C's apply)

PLACEMENT

PREPARATION

- Install electrical circuit(s) and outlet(s) in accordance with national and local electric codes
- Outlets should generally be mounted vertically unless a "twist/locking" type is being used
- Wall switch may be installed in circuit to disable power and prevent electrical hazards when servicing
- Confirm electrical continuity of Airius unit on the ground before permanently mounting in the ceiling

INSTALLATION

- Hang vertically as high in the ceiling as possible
Typically 300mm (12") - 450mm (18") from the roof deck to intake
- The Airius unit performs best when air column from the nozzle is unimpeded to the floor
- Use professionally installed hardware, capable of supporting a minimum of five times the weight
- Hardware to hang the unit includes but is not restricted to: Hooks, chains, cables, carabiners, bridle rings, beam clamps and bolts
- Density of the placement is directly related to the effectiveness, performance and savings
- Mount out of reach from people and animals
- Floor plans, mezzanines, office locations, machinery, people placement, plumbing, lighting, duct work, electrical systems, natural light/air systems, cranes, doors, windows, ventilation and fire suppression systems are all factors in properly locating the Airius system within the ceiling

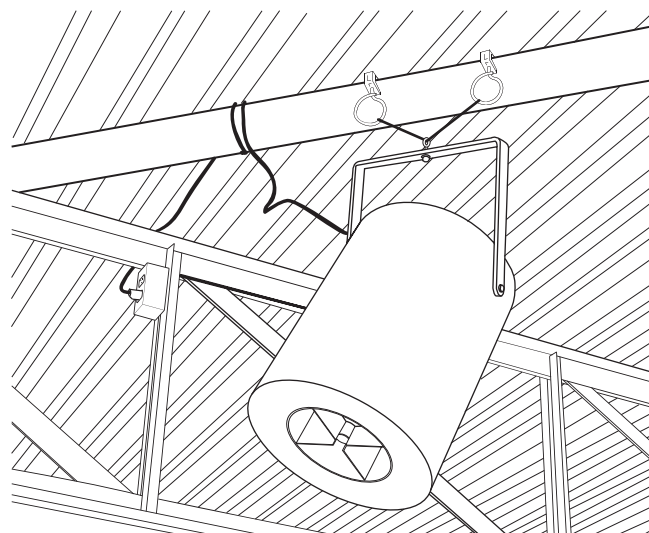

OPERATION

- Designed to operate 24 hours-a-day, 7 days-a-week to maintain thermal equalization/humidity equalization
- Use optional speed control to fine tune RPM if needed

MAINTENANCE

- Frequency of cleaning will vary by application and environment
- You may clean the plastic housing with a damp warm cloth, using mild household detergents
- Do not use petroleum products, thinners or solvents to clean any part of the Airius unit
- If the Airius unit fails, contact manufacturer



Airius LLC, © 2011. All Rights Reserved.

Airius Europe Ltd

Holwell Farm, Cranborne, Dorset BH21 5QP

www.airius.co.uk

+44 (0)1202 554200

Get In Touch

Call: 0845 6880112

Email: info@adremit.co.uk

Our Address

Puravent, Adremit Limited, Unit 5a, Commercial Yard,
Settle, North Yorkshire, BD24 9RH